



Security Tech Germany

# SECURITY SOLUTIONS SOLUTIONS DE SÉCURITÉ SOLUCIONES DE SEGURIDAD

CATALOGUE | CATALOGUE | CATÁLOGO



# WORLDWIDE



**ABUS** Head Office - Wetter, Germany



**ABUS** Production - Wetter, Germany



**ABUS** Production - Rehe, Germany



**ABUS** Production - Pfaffenhain, Germany



**ABUS** Security-Center - Augsburg, Germany



**ABUS** Production - China

## **ABUS IN GENERAL**

**PAGE: 6 - 12**

## **PADLOCKS**

**PAGE: 13 - 108**

GRANIT™	14 - 20
Rekeyable Padlocks	21 - 37
DISKUS®	38 - 45
Laminated-Padlocks	46
TITALIUM™	47 - 56
Silver-Rock	57
Brass Padlocks	58 - 71
Aluminium Padlocks	72 - 75
Love Lock	76 - 79
Combination Lock	80 - 95
Lever Padlocks	96
KEYGARAGE™	97 - 108

## **HASPS**

**PAGE: 109 - 118**

DISKUS® Integral	110 - 111
GRANIT™ Hasps	112
DISKUS® Hasp	113
Hinged Hasp	114
Standard Hasp	115 - 116
Locking Bracket	117
GateSec	118

## **WALL AND FLOOR ANCHOR**

**PAGE: 119 - 128**

Wall and Floor Anchor	120 - 122
Combiloop	124
Combiflex	124
Cobra	125
1850	125
Chains	126 - 128

## **LOCKOUT / TAGOUT**

**PAGE: 129 - 166**

Padlocks	131 - 137
Lockout Devices	138 - 158
LoTo Tags	159
Lockpoint	160 - 161
Bags	162
Lockout / Tagout Sets	163
Supportbox	164
Trainingstower	165
ABUS Emma	166

**DOOR CYLINDERS****PAGE: 167 - 182**

B5LT	169
TI12/ TI14	170 - 171
A93	173 - 174
D6 Basic	175 - 176
D10PS	177 - 178
ABUS Pfaffenhain	179 - 182

**DOOR SECURITY****PAGE: 183 - 210**

Door Bars	184 - 186
Rim Locks	187 - 191
Door Chains	192 - 193
Door Hinge Locks	194
Door Viewers	195 - 196
Door Fitting	197 - 198
Door Closer	199 - 203
Mortice Locks	204 - 207
Strike Plate	208 - 210

**WINDOW SECURITY****PAGE: 211 - 218**

Push Bolts	212 - 213
Window Lock	214
Door Hinge Lock	214
Roller Shutter Locks	215
Window Handles	216 - 218

**ELECTRONICS****PAGE: 219 - 234**

HomeTec Pro Bluetooth®	220 - 223
ABUS Security Center	224 - 225
Cameras	226 - 231
Surveillance Sets	232 - 233
Accessories	234

**EXTRA SOLUTION GADGETS****PAGE: 235 - 242**

Luggage Strap	236
Torches	237 - 238
Universal Bungee Set	240
Automotiv Security Bundle	240
ConHasps	241 - 242

**JUNIOR CARE**

Houshold & Kitchen	243 - 246
Cabinet & Drawer	246 - 251
Road Traffic & Outdoor	252 - 254
Door & Window	256 - 258
Sleep & Dream	259 - 262
Bathroom & Toilet	263 - 265
Pram & More	265 - 268
Stairs & Stair Gates	268 - 272
Corner & Edges	272 - 274

**PAGE: 243 - 274****FIRE PROTECTION**

Smoke alarm device	277 - 282
Hazard Detector	283 - 285, 289
Fire Protection	287 - 288
Accessories	286, 290

**PAGE: 275 - 290****MARKETING**

Shop in Shop	292 - 293
Tego	294
Modular Display System	295
Sample Cases	296
Service	297 - 298

**PAGE: 291 - 298****KEY BLANKS****PAGE: 299 - 303****INDEX****PAGE: 304 - 306**



**VALIDATED**

- ABUS HARDWARE LIMITED FACILITY HAS ACHIEVED ZERO WASTE TO LANDFILL GOLD OPERATIONS IN 2021 – 98% LANDFILL DIVERSION RATE
- 72, 74 AND 76 SERIES PADLOCKS CONTAIN AN AVERAGE OF 75% RECYCLED CONTENT  
[UL.COM/ECV](http://UL.COM/ECV)

# THE FIRST IN THE WORLD

All padlocks produced in our largest factory are ULE Validated.

Aluminium | Non-Conductive | Steel | Brass



ABUS padlocks are produced in the world's first factory to achieve virtually zero waste to landfill operations in 2012 at a 98% diversion rate.

This claim and rate are still valid after the latest review in 2021 - now with zero waste to landfill gold operations status.

ABUS 72, 74 and 76 Series safety padlocks contain a combined average of 75% recycled materials.



# OUR SUSTAINABILITY SEAL



## ECONOMY

We have a strong commitment to the longevity, quality and functionality of our security solutions, as well as the company mission of "making life more secure".

## ENVIRONMENT

The responsible handling of resources as well as the wide variety of materials and production tools has always been a part of our family company's intelligent economic management.

## SOCIAL AFFAIRS

At the ABUS Group, we live out the values embedded in the Christian faith. This can be seen in our community involvement in the form of supporting various charitable organisations in and outside the country. We feel connected to our region and the people who live there, leading us to support a number of projects and facilities such as day care centres, volunteer work, volunteer fire brigades and associations. ABUS is just as involved both nationwide and internationally, because we see that as our responsibility too.

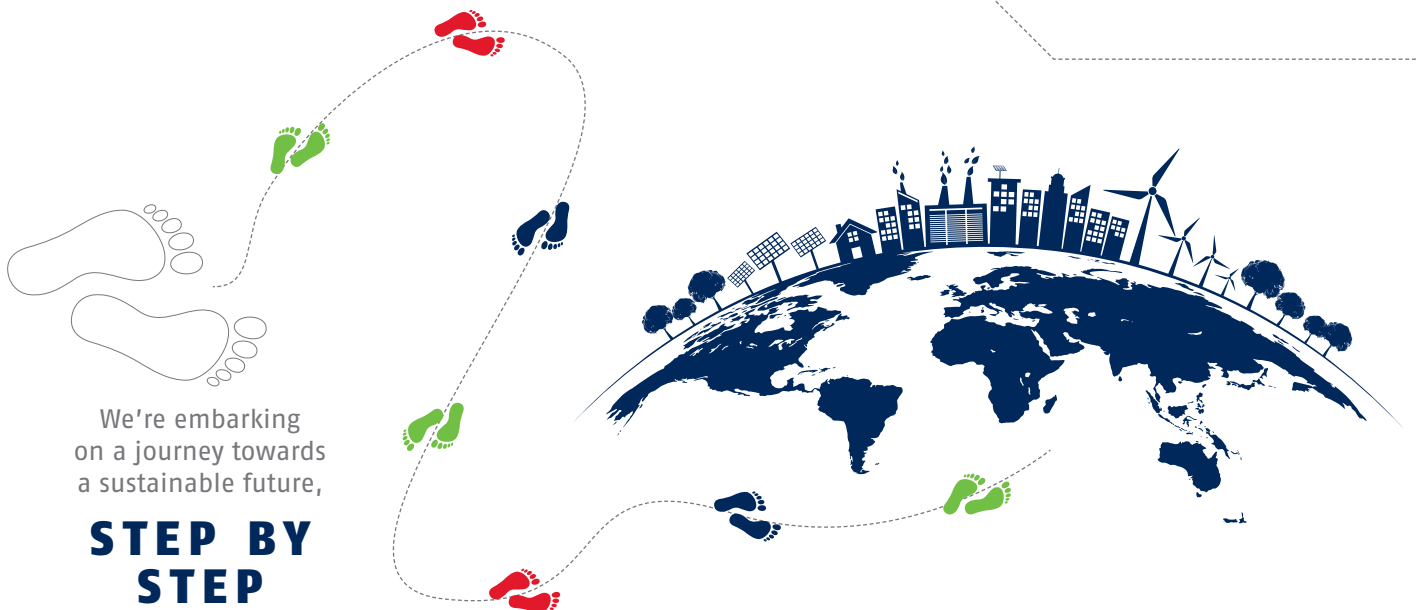
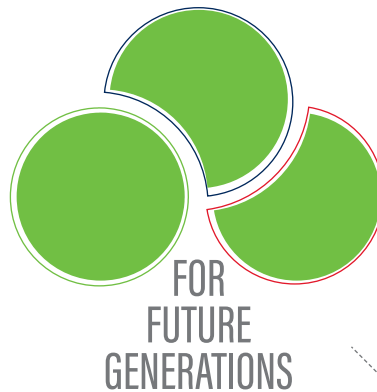

Do you have ideas or comments?  
Then please contact us at our e-mail address:  
[nachhaltigkeit@abus.de](mailto:nachhaltigkeit@abus.de)

## **Security is a matter of trust!**

### **More security with ABUS is based on:**

- More than 90 years of experience in lock design and manufacturing
- Intensive, ongoing exchange of professional experiences and information with police forces, insurance companies and independent test institutes
- Innovation in research, development and design
- High-precision manufacturing and quality control
- Made in Germany

The broad range of ABUS padlocks offers the right solution to meet all purposes and security requirements, from the basic padlock through to the ultimate security GRANIT™ padlocks.

The most modern production facilities at three sites in Germany and the use of high-grade materials guarantee the recognized quality level of ABUS products.

ABUS locks are tested and acknowledged by independent, neutral test institutes in several European countries.

## **La sécurité, c'est une question de confiance!**

### **Plus de sécurité basée sur:**

- Plus de 90 ans d'expérience
- Coopération intensive avec la police, les compagnies d'assurances et les instituts de tests internationaux
- Innovation toujours active sur le domaine du design, de la recherche et du développement
- Garantie d'une qualité constante
- Fabriqué en Allemagne

ABUS propose la bonne solution à toutes les situations et tous les besoins de sécurité. La gamme des cadenas ABUS est complète, du modèle traditionnel au produit de pointe GRANIT™ de très haute exigence.

Les trois sites de production les plus modernes et l'utilisation de matériaux de première qualité garantissent le haut niveau de qualité reconnu des produits ABUS.

Dans divers pays européens, les produits ABUS sont testés par des instituts d'essais neutres et indépendants, ceci sur base régulière.

## **La seguridad es una cuestión de confianza!**

### **La mayor seguridad que proporciona ABUS está basada en:**

- 90 años de experiencia en el diseño y fabricación de cerraduras
- Intercambio intensivo y activo de experiencias profesionales e información con fuerzas policiales, compañías de seguros e institutos independientes de pruebas
- Innovación en la investigación, desarrollo y diseño
- Control de calidad permanente
- Fabricado en Alemania

La amplia gama de productos de ABUS ofrece la solución correcta que satisface todas las necesidades y requisitos de seguridad, desde el candado básico hasta los productos de seguridad GRANIT™ más avanzados.

Las modernas instalaciones de producción ubicadas en las tres fábricas de Alemania y el uso de materiales sofisticados, garantizan el reconocido nivel de calidad de los productos ABUS.

Los productos ABUS están probados y reconocidos por institutos de pruebas independientes y neutrales de diferentes países europeos.



# PICTOGRAMS



100% rust-free: all parts of the lock are made from non-corrosive materials  
<<100% non-corrosif>>: Tout le mécanisme intérieur du cadenas est en 100% anti-corrosion, fabriqué avec des matériaux non-corrosifs  
100% inoxidable: todos los componentes del candado están fabricados con materiales no corrosivos



Highly corrosion resistant due to surface protection  
Protection anti-corrosion très élevée grâce à un traitement spécial de la surface  
Muy alta resistencia a la corrosión gracias a un tratamiento especial de la superficie



Paracentric keyway: resists professional picking by special key profile  
<<Profil de clé paracentrique>>: Profil de haute technique offrant une protection anti-manipulation élevée  
Perfil de llave paracéntrico: protección anti-ganzúa gracias a perfil especial



Drill protection: cylinder is protected against drilling and leverage  
<<Anti-perçage>>: Le cylindre avec protection anti-perçage et anti-arrachage  
Protección anti-taladro: el cilindro está protegido contra taladros y apalancamiento



Bolt cutter attack resistant  
Protection anti-coupe-boulon  
Protección anti-cizalla



Saw attack resistant  
Protection anti-sciage  
Protección contra sierra



Hammer & impact attack resistant  
Protection anti-coups de masse  
Protección contra golpes de martillo



Shackle made from hardened steel  
Anse en acier spécial, cémenté  
Arco de acero especial endurecido



Sophisticated plating for extreme corrosion resistance  
Revêtement pour une meilleure protection contre la corrosion  
Recubrimiento para una extrema resistencia contra la corrosión



Lock body made from special aluminum alloy - light but secure  
Boîtier en alliage aluminium spécial - poids léger, sûreté élevée  
Cuerpo macizo de aleación especial de aluminio - ligero y seguro



Development and production in Germany  
Construction et fabrication allemande  
Desarrollo y producción en Alemania



Shackle Guard: shackle access restricted, protecting shackle from attack  
<<Anse blindée>>: Anse protégée et pratiquement inaccessible au coupe-boulon  
Protector de arco: dificulta el acceso al arco, protegiéndolo de ataques



Solid steel ball locking  
Technique de verrouillage à billes, très solide  
Cierre de bolas de acero macizo



Double-bolted: both sides of the shackle are secured by bolts or balls – increased protection against attacks and manipulation  
<<Double verouillage>>: L'anse est verrouillée des deux côtés, soit par billes, soit par pêne  
Doble cierre: ambos lados del arco están asegurados con bulones o bolas - aumenta la protección contra ataques y manipulaciones



Automatic-locking: the lock is locked automatically by pushing down the shackle – no key needed for locking  
<<Auto-fermeture>>: Fermeture automatique en appuyant sur l'anse, sans clé  
Cierre automático: la cerradura se cierra automáticamente empujando hacia abajo el arco – no es necesaria una llave para cerrar



Key-retaining: a key is needed for locking. Lock retains key until locked  
<<Clé prisonnière>>: Pour fermer le cadenas, la clé est indispensable  
Retención de llave: se necesita una llave para cerrar. La cerradura retiene la llave hasta que se cierre



RK: cylinder can be taken out and can be rekeyed to match an existing key  
RK: Le cylindre peut être adapté à une fermeture déjà existante  
RK: el cilindro se puede extraer y modificar para adaptarlo a una llave existente



MK: available master-keyed (one key opens many different locks)  
MK: Disponible sur organigramme (une clé <<passé>> ouvre plusieurs cadenas qui eux-mêmes sont équipés chacun de leur propre clé)  
MK: disponibilidad de amaestramiento (una sola llave maestra abre muchas cerraduras)



Resettable code  
Code interchangeable  
Código re-programable



ABUS-Plus: original ABUS-Plus disk cylinder – highest precision, highest security  
ABUS-Plus: cylindre à disques ABUS-Plus – L'original d'une précision et sûreté sur le niveau top  
ABUS-Plus: cilindro ABUS-Plus con discos - muy alta precisión y seguridad

# PICTOGRAMS



Dimple key, no sharp edges and can be inserted either way up.  
Clé à micro-points et réversible, sans pointes aiguës  
Llave de puntos, sin bordes afilados y puede introducirse cualquier forma.



LED key  
Clé lumineuse équipée d'une LED  
Llave con LED



Spare keys are made only upon presentation of Code Card  
Reproduction de clés uniquement sur présentation de la carte de propriété  
El duplicado de llaves se realiza solamente ante presentación de la Tarjeta de Código



New locks can be made up to a sample key  
Cadenas délivrés sur clé modèle  
Las cerraduras se pueden amaestrar según llave de muestra



Predetermined breaking point makes the unauthorized opening of the door more difficult  
Avec système anti-arrachement  
Puntos de rotura predefinidos para dificultar aún más el intento de apertura no autorizado



Resistant to the most common attack - leverage  
Protection anti-levier (méthode la plus courante des cambrioleurs)  
Resiste la palanqueta, el más común de los útiles de robo



Door guard protects internal occupants  
Protection par un entrebâilleur  
Pestillo: protege a los ocupantes en el interior



Freeze spray attack resistant  
Testé au spray anti-gel  
Resistente a sprays de hielo



Distance between center of door cylinder and center of thumb turn or handle  
Entraxe cylindre-poignée  
Distancia entre el centro del cilindro y el centro del pomo o manilla



Distance between center of door cylinder and center of thumb turn or handle  
Entraxe cylindre-poignée  
Distancia entre el centro del cilindro y el centro del pomo o manilla



Gives pulling protection to door cylinders  
Cylindre avec protection anti-arrachage  
Protección anti-extracción para los cilindros



For doors with hinges on the left side  
Utilisation pour porte poussant gauche / tirant gauche  
Para puertas con bisagras a la izquierda



For doors with hinges on the right side  
Utilisation pour porte poussant droite / tirant droite  
Para puertas con bisagras a la derecha



The cylinder can be operated from the outside even when a key is already inserted on the inside  
Ouverture de l'extérieur même lorsqu'une clé est introduite à l'intérieur  
El cilindro puede ser operado desde el exterior incluso cuando ya hay una llave insertada en el interior



Cylinder protrusion on the outside max. 3 mm according to DIN  
Selon la norme DIN, le cylindre ne devrait dépasser que de 3 mm au maximum à l'extérieur de la porte  
Protusión máxima del cilindro en el exterior de la puerta según norma DIN: 3 mm



Interchangeable shackle  
Anse interchangeable  
Arco intercambiable



For a door weight of max. xxx kg  
Pour un poids de porte de max. xxx kg  
Para un peso de puerta de máx. xxx kg



Emergency function: Lock operates even when keys inserted in both sides simultaneously  
Fonction débrayable: ouverture de l'extérieur même lorsqu'une clé est introduite à l'intérieur  
Se puede abrir aún cuando hay una llave metida por el interior



Conforms to CEN requirements EN 12320, grade 4  
Conforme à la DIN EN 12320, classe 4  
Grado 4, CEN EN 12320



Spare keys only produced on presentation of security card  
Cylindres et clés de rechange peuvent être délivrés sur présentation de la carte de propriété  
Cilindros y llaves adicionales solo se hacen bajo presentación de la tarjeta de seguridad troquelada

# PICTOGRAMS



Locking steel bolts  
Ancrage des pènes de verrouillage  
Condenas de acero de alta resistencia a ataques con palanca



For sliding windows and doors  
Pour portes et fenêtres coulissantes  
Para puertas y ventanas conrederas



For outward opening windows  
Pour fenêtres à ouverture extérieure  
Ventanas de apertura hacia el exterior



For inward opening windows  
Pour fenêtre à ouverture intérieure  
Ventanas de apertura hacia el interior



a) Replacement cylinders and spare keys only produced on presentation of code card  
b) Padlocks and spare keys are only offered on presentation of the code card  
a) Des cylindres et clés de rechange ne peuvent être délivrés que sur présentation de la carte de propriété  
b) Des cadenas et clés de rechange ne sont délivrés que sur présentation de la carte de propriété  
a) Reproducción de llaves y cilindros bajo presentación de la tarjeta de propiedad codificada  
b) Tarjeta codificada que permite suministrar candados y copias de llaves sin presentar la muestra original



Leverage attack resistant (withstands pulling force in excess of 8 (6) tons)  
Plus de 8 (6) tonnes de résistance à la traction  
Resistencia al estiramiento del arco mayor de 8 (6) toneladas



With 5 (3) keys  
Avec 5 (3) clés  
Con 5 (3) llaves



KA: available keyed-alike (several locks with the same key)  
KA: disponible en exécution s'ouvrant (plusieurs cadenas s'ouvrent avec la même clé)  
KA: Disponibilidad de llaves iguales (varias cerraduras con la misma llave)

# ABBREVIATIONS

	Abbreviations	Abréviations	Abreviaciones
AM	American® Keyway	Profil American®	Perfil American®
AS	Aluminum Shackle	Anse en aluminium	Arco de aluminio
BS	Bare Shackle	Anse nue	Arco descubierto
CS	Concealed Shackle	Anse voilée	Arco cubierto
DG	Double Link	Double articulations	Doble articulación
HB	Long Shackle (in mm)	Anse longue (en mm)	Arco largo (en mm)
IB	Stainless Steel Shackle	Anse en acier inox	Arco de acero inoxidable
IC	Interchangeable Core	Rotor interchangeable	Rotor intercambiable
LFIC	Large Format Interchangeable Core	Rotor interchangeable en grand format	Rotor intercambiable de formato grande
KA	Keyed Alike	Une même clé	Llaves iguales
KC	Key Control	Avec clé de contrôle	Con llave de control
KD	Keyed Differently	Avec clés différentes	Con llaves diferentes
KnK	Key in Knob	Avec adaptateur pour serrure à bouton	Con llave en pomo
M1	Master® M1 Keyway	Profil Master® M1	Perfil Master® M1
MB	Brass Shackle	Anse en laiton	Arco de latón
MK	Master Keyed	Clé PP et PG	Amaestramiento
RK	Rekeyable	Serrure interchangeable	Amaestable
SFIC	Small Format Interchangeable Core	Rotor de petite taille, interchangeable	Rotor intercambiable de formato pequeño
SGT	Sargent	Cylindre Sargent	Cilindro Sargent
SZP	Key Copy Protection	protection anti-copie de la clé	protección anticopia de llaves
UK	You Key	Codifier vous-même	Codificable por uno mismo
WP	Weatherproof	Protégé contre les intempéries	Apto a la intemperie
Z	Galvanized Body	Boîtier galvanisé	Cuerpo galvanizado
ZM	Galvanized Body, Brass Mechanism	Boîtier galvanisé, mécanisme en laiton	Cuerpo galvanizado, mecanismo de latón
OB	Zero Bitted	0-bitted	Semi-montado, codificado a ceros

# TEST SEALS

ABUS products are tested and acknowledged by independent, neutral test institutes in several European countries that confirm the extraordinary security of ABUS products:



DIN CERTCO  
GESELLSCHAFT FÜR KONFORMITÄTS-  
BEWERTUNG MBH –  
BERLIN, GERMANY



SKG-IKOB CERTIFICATION –  
GELDERMALSEN, NETHERLANDS

DIN EN  
12320  
KI. 1

DIN NORMENAUSSCHUSS –  
BERLIN, GERMANY



SVENSK BRAND- OCH  
SÄKERHETSCERTIFIERING AB –  
STOCKHOLM, SWEDEN



Ö-NORM, AUSTRIAN STANDARDS  
INTERNATIONAL –  
VIENNA, AUSTRIA



VDS –  
COLOGNE, GERMANY



AV-TEST GMBH  
MAGDEBURG, GERMANY



FORSIKRING & PENSION –  
HELLERUP, DENMARK



POLITIEKEURMERK VEILIG WONEN  
UTRECHT, NETHERLANDS



NORGES FORSIKRINGSFORBUND –  
OSLO, NORWAY



MATERIALPRÜFUNGSAMT  
NORDRHEIN-WESTFALEN  
DORTMUND, GERMANY



BSI KITEMARK –  
LONDON, GREAT BRITAIN



OSIMZ  
MOSCOW, RUSSIA



QUALITÄTSZEICHEN FÜR  
RAUCHMELDER FORUM  
BRANDRAUCHPRÄVENTION E.V.  
BERLIN, GERMANY



FINANSSIALA  
HELSINKI, FINLAND



KRIWAN TESTZENTRUM –  
FORCHTENBERG, GERMANY



SOLD SECURE  
RUGBY, GREAT BRITAIN



ART (ANWB, RAI, THEFT INSURERS)  
NIJMEGEN, NETHERLANDS

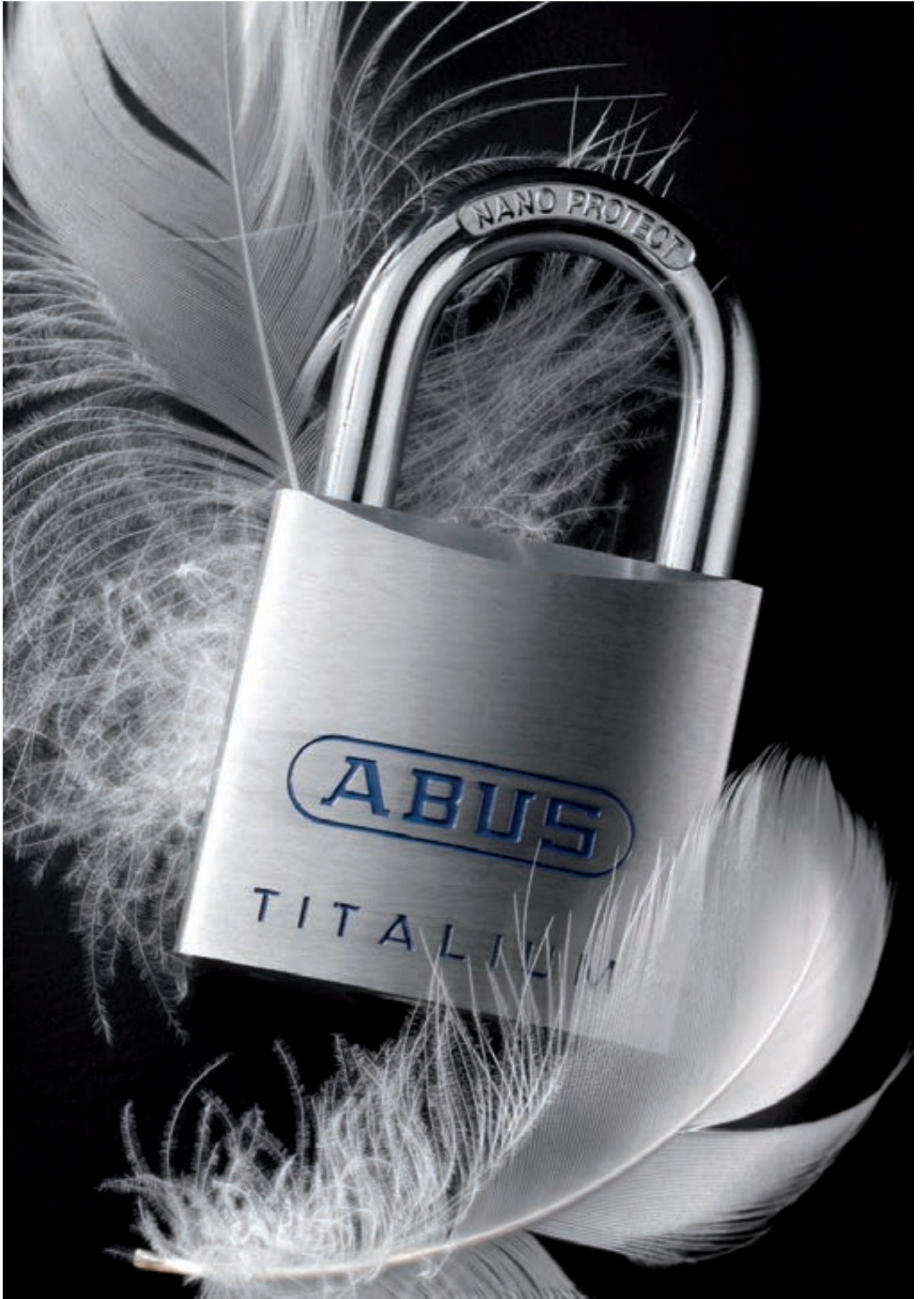

# GRANIT™ PADLOCKS



GRANIT™ locks are among the most secure padlocks in the world. They were developed to meet the highest demands for quality and security. All around the globe, industrial and commercial customers rely on the special features of this lock series.

GRANIT™ products are extremely well-protected against most common threats. They withstand physical attacks with bolt cutters, power drills, prying bars or hammers. They can be used outside over many years without showing any signs of rust and therefore fatigue. And with their disk cylinders, they are also highly resistant to manipulation methods like picking or bumping.

GRANIT™ padlocks are the best choice when truly valuable things need to be secured.

The lock series is now available also with a security card. This card is needed to get additional keys produced which gives the owner of the lock full control over the number of existing keys.



# GRANIT™ 37RK/80

FOR ULTIMATE SECURITY REQUIREMENTS



Service Kit

Made in Germany

DIN EN  
12320  
Kl. 5



## TECHNOLOGY AND FEATURES

- ABUS-Plus disc cylinder: highest protection against manipulation
- Body and shackle made from hardened alloy steel
- Black Granit coating for even more corrosion resistance
- SZP: comes with security card to protect against unauthorized key duplicates
- RK: cylinder can be re-keyed to match an existing ABUS-Plus key
- 2 keys, 1 with LED light
- Shackle guard protects against attacks with tools
- Cylinder inserted from the top: optimum drill and pull resistance
- Shackle can be taken out

## CARACTÉRISTIQUES TECHNIQUES

- Cylindre à disques ABUS Plus : précision maximale contre les manipulations
- Corps et anse en acier durci spécial
- Revêtement Black Granit pour une résistance supplémentaire à la corrosion
- SZP : version avec carte de protection pour vous prémunir contre les reproductions de clés à votre insu
- RK : cylindre pouvant être adapté aux fermetures ABUS Plus existantes
- 2 clés, dont une avec LED
- L'anse rend difficile l'effraction avec des outils
- Cylindre inséré par le haut : protection optimale contre le perçage et l'arrachement
- Anse détachable

## CARACTERÍSTICAS TÉCNICAS

- Cilindro de disco Plus de ABUS: máxima precisión contra manipulación
- Cuerpo y arco de acero especial endurecido
- Revestimiento Black Granit para una mejor protección anticorrosiva
- SZP: la versión con tarjeta de seguridad protege las copias de llaves indeseadas
- RK: el cilindro puede adaptarse a los cierres Plus existentes de ABUS
- 2 llaves, una de ellas con LED
- La protección del arco dificulta el acceso de instrumentos para forzar la apertura
- Cilindro con introducción superior: óptima protección antitaladro y antiextracción
- Arco extraíble

Ref. No. Référence Referencia	EAN 4003318							Weight g Poids g Peso g	Key Blank Ébauche Llave en bruto	Level Degré Nivel	Box Quantity Unité d'emballage Cantidad de cajas
		mm	mm	mm	mm	mm	mm				
37RK/80 B/EFSP	43121 0	79	22	22	14	39	94	1050	05078	10	1
37RK/80 SZP Profil B/EFSP	79173 4	79	22	22	14	39	94	1200	83137	10	1
37RK/80 SA pre-assembled	35905 7	79	22	22	14	39	94	600	05078	10	1
Master Key ABUS-PLUS	04325 3										1
Master Key ABUS-PLUS SZP	84184 2										1

## SURCHARGE / MAJORATION / RECARGO

- Keyed alike / S'entrouvrant / Llaves iguales
- Keyed alike as per sample / Fermeture selon échantillon / Cierre según muestra
- Master key function / Clé passe / Funcion llave maestra

# GRANIT™ 37RK/70

FOR HIGHEST SECURITY REQUIREMENTS



DIN EN  
12320  
Kl. 5



## TECHNOLOGY AND FEATURES

- ABUS-Plus disc cylinder: highest protection against manipulation
- Body and shackle made from hardened alloy steel
- Black Granit coating for even more corrosion resistance
- SZP: comes with security card to protect against unauthorized key duplicates
- RK: cylinder can be re-keyed to match an existing ABUS-Plus key
- 2 keys, 1 with LED light
- Cylinder inserted from the top: optimum drill and pull resistance

## CARACTÉRISTIQUES TECHNIQUES

- Cylindre à disques ABUS Plus : précision maximale contre les manipulations
- Corps et anse en acier durci spécial
- Revêtement Black Granit pour une résistance supplémentaire à la corrosion
- SZP : version avec carte de protection pour vous prémunir contre les reproductions de clés à votre insu
- RK : cylindre pouvant être adapté aux fermetures ABUS Plus existantes
- 2 clés, dont une avec LED
- Cylindre inséré par le haut : protection optimale contre le perçage et l'arrachement

## CARACTERÍSTICAS TÉCNICAS

- Cilindro de disco Plus de ABUS: máxima precisión contra manipulación
- Cuerpo y arco de acero especial endurecido
- Revestimiento Black Granit para una mejor protección anticorrosiva
- SZP: la versión con tarjeta de seguridad protege las copias de llaves indeseadas
- RK: el cilindro puede adaptarse a los cierres Plus existentes de ABUS
- 2 llaves, una de ellas con LED
- Cilindro con introducción superior: óptima protección antitaladro y antiextracción

Ref. No. Référence Referencia	EAN 4003318							Weight g Poids g Peso g	Key Blank Ébauche Llave en bruto	Level Degré Nivel	Box Quantity Unité d'emballage Cantidad de cajas
		mm	mm	mm	mm	mm	mm				
37RK/70 B/EFSP	43118 0	77	29	35	14	37	103	980	05078	10	1
37RK/70 SZP Profil B/EFSP	79162 8	77	29	35	14	37	103	1041	83137	10	1
37RK/70 pre-assembled	33558 7	77	29	35	14	37	103	300	05078	10	1
37RK/70HB100	45091 4	77	29	100	14	37	169	1000	05078	10	1
37RK/70HB100 SZP Profil	79169 7	77	29	100	14	37	169	1060	83137	10	1
Master Key ABUS-PLUS	04325 3										1
Master Key ABUS-PLUS SZP	84184 2										1

## SURCHARGE / MAJORATION / RECARGO

- Keyed alike / S'entrouvrant / Llaves iguales
- Keyed alike as per sample / Fermeture selon échantillon / Cierre según muestra
- Master key function / Clé passe / Funcion llave maestra



# GRANIT™ 37/60

FOR HIGHEST SECURITY REQUIREMENTS



Service Kit



## TECHNOLOGY AND FEATURES

- ABUS-Plus disc cylinder: highest protection against manipulation
- Body and shackle made from hardened alloy steel
- Black Granit coating for even more corrosion resistance
- SZP: comes with security card to protect against unauthorized key duplicates
- 2 keys, 1 with LED light
- Shackle guard protects against attacks with tools
- Cylinder inserted from the top: optimum drill and pull resistance
- Shackle can be taken out

## CARACTÉRISTIQUES TECHNIQUES

- Cylindre à disques ABUS Plus : précision maximale contre les manipulations
- Corps et anse en acier durci spécial
- Revêtement Black Granit pour une résistance supplémentaire à la corrosion
- SZP : version avec carte de protection pour vous prémunir contre les reproductions de clés à votre insu
- 2 clés, dont une avec LED
- L'anse rend difficile l'effraction avec des outils
- Cylindre inséré par le haut : protection optimale contre le perçage et l'arrachement
- Anse détachable

## CARACTERÍSTICAS TÉCNICAS

- Cilindro de disco Plus de ABUS: máxima precisión contra manipulación
- Cuerpo y arco de acero especial endurecido
- Revestimiento Black Granit para una mejor protección anticorrosiva
- SZP: la versión con tarjeta de seguridad protege las copias de llaves indeseadas
- 2 llaves, una de ellas con LED
- La protección del arco dificulta el acceso de instrumentos para forzar la apertura
- Cilindro con introducción superior: óptima protección antitaladro y antiextracción
- Arco extraíble

Ref. No. Référence Referencia	EAN 4003318							Weight g Poids g Peso g	Key Blank Ébauche Llave en bruto	Level Degré Nivel	Box Quantity Unité d'emballage Cantidad de cajas
		mm	mm	mm	mm	mm	mm				
37/60 B/EFSP	32380 5	65	18	16	11	35	85	580	05078	10	2
37/60 SZP Profil B/EFSP	79151 2	65	18	16	11	35	85	683	83137	10	1
Master Key ABUS-PLUS	04325 3										1
Master Key ABUS-PLUS SZP	84184 2										1

## SURCHARGE / MAJORATION / RECARGO

- Keyed alike / S'entrouvrant / Llaves iguales
- Keyed alike as per sample / Fermeture selon échantillon / Cierre según muestra
- Master key function / Clé passe / Funcion llave maestra

# GRANIT™ 37/55 | 37RK/55

FOR HIGHEST SECURITY REQUIREMENTS



37RK/55

37RK/55HB50

37/55 S&S

Service Kit



## DIN EN

12320

Kl. 4



Kl. 3



37/55

37/55  
37/55HB50

37/55  
37/55HB50

37/55  
37/55HB50



37RK/55

## TECHNOLOGY AND FEATURES

- ABUS-Plus disc cylinder: highest protection against manipulation
- Body and shackle made from hardened alloy steel
- Black Granit coating for even more corrosion resistance
- SZP: comes with security card to protect against unauthorized key duplicates
- RK: cylinder can be re-keyed to match an existing ABUS-Plus key
- 2 keys, 1 with LED light

## CARACTÉRISTIQUES TECHNIQUES

- Cylindre à disques ABUS Plus : précision maximale contre les manipulations
- Corps et anse en acier durci spécial
- Revêtement Black Granit pour une résistance supplémentaire à la corrosion
- SZP : version avec carte de protection pour vous prémunir contre les reproductions de clés à votre insu
- RK : cylindre pouvant être adapté aux fermetures ABUS Plus existantes
- 2 clés, dont une avec LED

## CARACTERÍSTICAS TÉCNICAS

- Cilindro de disco Plus de ABUS: máxima precisión contra manipulación
- Cuerpo y arco de acero especial endurecido
- Revestimiento Black Granit para una mejor protección anticorrosiva
- SZP: la versión con tarjeta de seguridad protege las copias de llaves indeseadas
- RK: el cilindro puede adaptarse a los cierres Plus existentes de ABUS
- 2 llaves, una de ellas con LED

Ref. No. Référence Referencia	EAN 4003318							Weight g Poids g Peso g	Key Blank Ébauche Llave en bruto	Level Degré Nivel	Box Quantity Unité d'emballage Cantidad de cajas
		mm	mm	mm	mm	mm	mm				
37/55 B/EFSP	32170 2	62,5	27,5	26,5	11	31	84	415	05078	10	3
37/55 SZP Profil B/EFSP	79124 6	62,5	27,5	26,5	11	31	84	540	83137	10	2
37/55HB75	12088 6	62,5	27,5	75	11	31	133,5	553	05078	10	1
37/55HB75 SZP Profil	79134 5	62,5	27,5	75	11	31	133,5	553	83137	10	1
37/55HB100	45090 7	62,5	27,5	100	11	31	158,5	650	05078	10	1
37RK/55	07783 8	62,5	27,5	26,5	11	31	84	445	05078	10	3
37RK/55 SZP Profil	79139 0	62,5	27,5	26,5	11	31	84	475	83137	10	3
37RK/55 SA pre-assembled	79142 0	62,5	27,5	26,5	11	31	84	300	83137	10	1
37RK/55HB50	23238 1	62,5	27,5	50	11	31	108,5	510	05078	10	3
37RK/55HB50 SZP Profil	79143 7	62,5	27,5	50	11	31	108,5	510	83137	10	3
37/55 S&S B/EFSP	32441 3	62,5	27,5	26,5	11	31	84	445	05078	10	3
37/55 S&S SZP Profil B/EFSP	79145 1	62,5	27,5	26,5	11	31	84	630	83137	10	2
Master Key ABUS-PLUS	04325 3										1
Master Key ABUS-PLUS SZP	84184 2										1

## SURCHARGE / MAJORATION / RECARGO

- Keyed alike / S'entrouvrant / Llaves iguales
- Keyed alike as per sample / Fermeture selon échantillon / Cierre según muestra
- Master key function / Clé passe / Funcion llave maestra

# GRANIT™ 37ST

FOR HIGHEST SECURITY REQUIREMENTS



37/55 SZP



KI. 3



## TECHNOLOGY AND FEATURES

- ABUS-Plus disc cylinder: highest protection against manipulation
- Massive lock body and shackle made of stainless steel
- Inner components made of non-corrosive materials
- SZP: comes with security card to protect against unauthorized key duplicates
- 2 keys, 1 with LED light

## CARACTÉRISTIQUES TECHNIQUES

- Cylindre à disques ABUS Plus : précision maximale contre les manipulations
- Corps du cadenas et anse massifs en acier inoxydable haut de gamme
- Pièces intérieures en matériaux haut de gamme, résistants à la corrosion
- SZP : version avec carte de protection pour vous prémunir contre les reproductions de clés à votre insu
- 2 clés, dont une avec LED

## CARACTERÍSTICAS TÉCNICAS

- Cilindro de disco Plus de ABUS: máxima precisión contra manipulación
- Cuerpo macizo y arco del candado de acero inoxidable de alta calidad
- Partes interiores de materiales anticorrosivos de alta calidad
- SZP: la versión con tarjeta de seguridad protege las copias de llaves indeseadas
- 2 llaves, una de ellas con LED

Ref. No. Référence Referencia	EAN 4003318							Weight g Poids g Peso g	Key Blank Ébauche Llave en bruto	Level Degré Nivel	Box Quantity Unité d'emballage Cantidad de cajas
		mm	mm	mm	mm	mm	mm				
37ST/55 SZP Profil B/EFSP	81384 9	62,5	27,5	26,5	12	31	84	583	83137	10	2
Master Key ABUS-PLUS	04325 3										1
Master Key ABUS-PLUS SZP	84184 2										1

## SURCHARGE / MAJORATION / RECARGO

- Keyed alike / S'entrouvrant / Llaves iguales
- Keyed alike as per sample / Fermeture selon échantillon / Cierre según muestra
- Master key function / Clé passe / Funcion llave maestra

# PLATINUM 35/55

FOR HIGHEST SECURITY REQUIREMENTS



DIN EN  
12320  
Kl. 4



Kl. 3



## TECHNOLOGY AND FEATURES

- ABUS-Plus disc cylinder: highest protection against manipulation, extremely high numbers of key differs
- Chrome plated body and shackle made from hardened alloy steel
- Constructed and tested according to SSFN Kl. 3
- Double-bolted

## CARACTÉRISTIQUES TECHNIQUES

- Cylindre à disques ABUS Plus : précision maximale contre les manipulations, nombre de fermetures extrêmement élevé
- Anse et corps chromé en acier cémenté
- Construit et testé selon la norme SSFN classe 3
- Double verrouillage

## CARACTERÍSTICAS TÉCNICAS

- Cilindro de discos ABUS Plus: máxima precisión contra manipulación, número de combinaciones posibles extremadamente alto
- Cuerpo y arco de acero endurecido cromado
- Construido y probado de acuerdo con la SSFN clase 3
- Doble cierre de bola

Ref. No. Référence Referencia	EAN 4003318	mm	mm	mm	mm	mm	mm	Weight g Poids g Peso g	Key Blank Ébauche Llave en bruto	Level Degré Nivel	Box Quantity Unité d'emballage Cantidad de cajas
35/55	80448 9	55	25	28	11	25	87	554	5078	9	10

# 83 SERIES 2

BEST REKEYABLE EVER

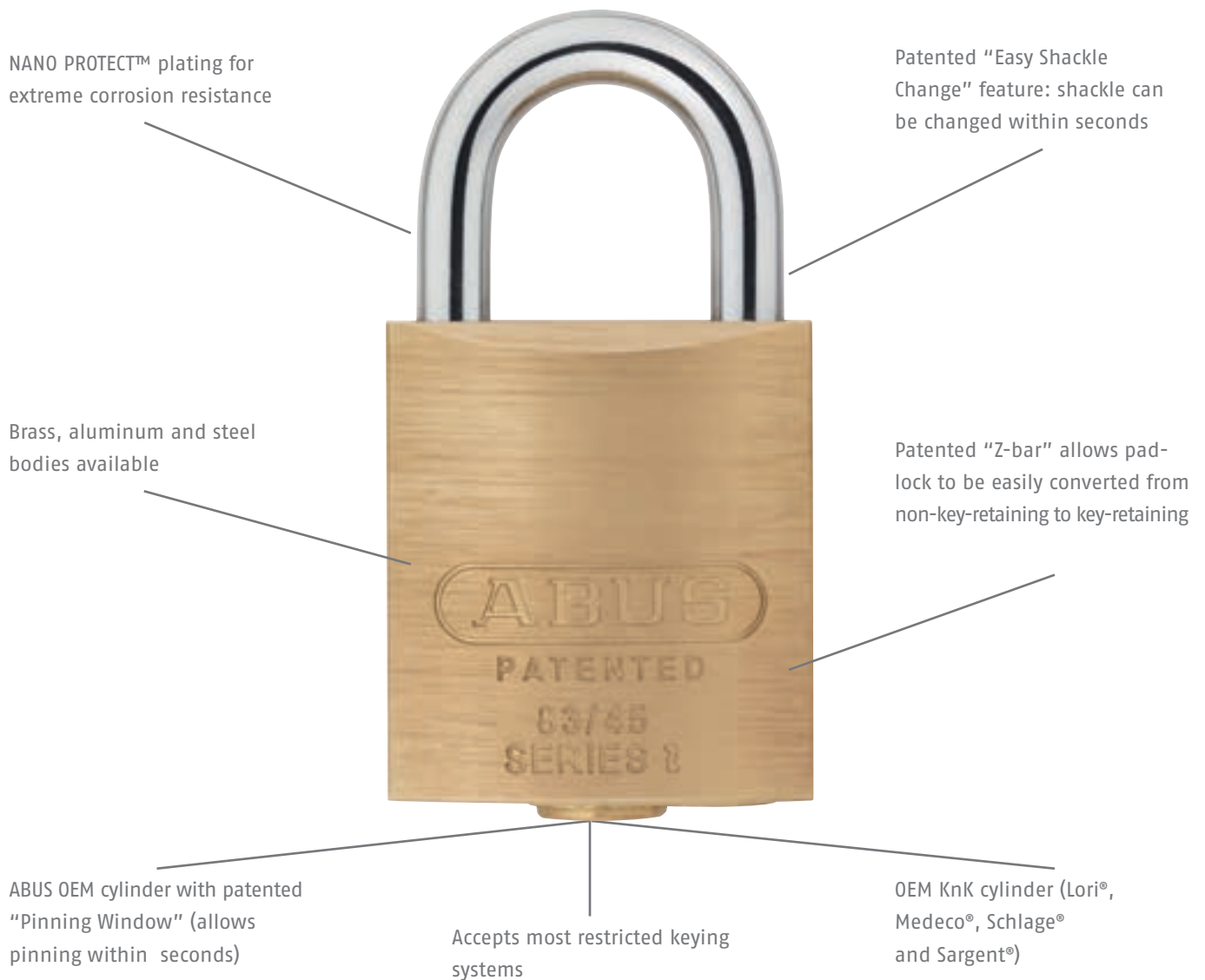

# 83 SERIES 2

## FEATURES & ACCESSORIES

### Patented "Pinning Window"

The patented pinning window allows you to re-pin our cylinder in seconds without having to remove the inner core.



### Shackles in mm

#### NANO PROTECT™



83/40	83/45	83/50	83/55	83WP/53	83WP/63
	19			19	
25	25	25	25	28	
38	38	38	38		35
50	50	50	50	63	63
75	75	75	75	75	
100	100	100	100	100	100
	150			125	

#### Stainless Steel



83/40	83/45	83/50	83WP/53
	19		19
25	25	25	28
	38	38	
50	50	50	63
75	75	75	75
	100	100	100
			125

#### Brass



83/45	83/50
19	
25	25
38	38
50	50
75	75
100	100

### Patented "Z-Bar"

Converts ABUS Padlock from key-retaining to non-key-retaining

- 1: Unlock padlock
- 2: Remove the #2 Phillips head screw in the shackle hole
- 3: Remove cylinder from the padlock. Use the key to remove the cylinder after screw is removed.

**It is important that the shackle is left in open position at all times until the reassembling is finished!**

- 4: For non-key-retaining remove Z-bar
- 5: For key-retaining insert Z-bar on the end of the cylinder with black dot facing up
- 6: Reassemble padlock by replacing the cylinder. It is necessary to turn the cylinder to the open position when using the Z-bar. The cylinder should be flush with the base of the padlock body.
- 7: Re-install #2 Phillips head screw and tighten

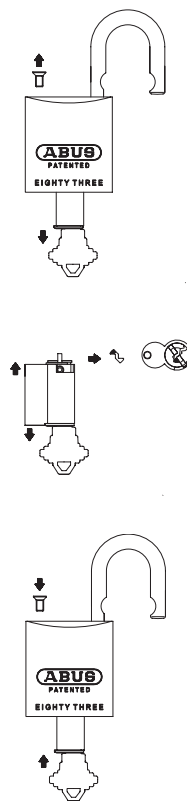

### New "Easy Shackle Change Tool"

- 1: Unlock padlock
- 2: Remove the #2 Phillips head screw in the shackle hole
- 3: Remove cylinder from padlock. Use the key to remove the cylinder after screw is removed.

**It is important that the shackle is left in the open position at all times until the reassembling is finished!**

- 4: Use "Easy Shackle Change Tool". Insert the tool vertically into the lock so that the end fits right between the two triangles. Turn tool clockwise until shackle is released.
- 5: Remove the existing shackle
- 6: Install new shackle, release bolt driver to retain shackle
- 7: Re-install cylinder into padlock body
- 8: Re-install #2 Phillips head screw and tighten

**IMPORTANT NOTE:** The shackle can only be changed when the cylinder is removed. It is recommended to lubricate occasionally with ABUS PS88.



100  
Yale  
No. 8

200  
Kwikset  
5 Pin

300&306  
Schlage  
C

EVER  
Schlage  
EVER

400  
Corbin 60  
59A1,  
59A2,  
59B1,  
59B2

410  
Corbin  
L4

700  
Sargent  
LA-LC

800  
Weiser  
Falcon

900  
Arrow

1000  
Russwin  
D1-D4

3000  
Schlage  
C-L

6000  
Master  
W6000

M1  
Master  
M1

WY

WR2

888

EC550

EC660

C83

A93

\* Schlage C300 is 5-6 pin loaded and Schlage C306 is a 6-6 pin loaded, Schlage EVER is a composite that will fit all Schlage Everest C keyways.  
\*\*Available in two different finishes: „brass lacquered“ & „nickel plated“

**KnK Cylinder Compatibility**

Most OEM KnK cylinder assemblies will fit into the 83 Series 2 padlocks. The use of special adapters is required.



Bible Cover

83 Series 2 Drivers  
Schlage & Primus, Medeco,  
Lori/Sargent

**Shackle Changing Tools**

There are two shackle changing tools for use with ABUS 83 Series 2. Version 1 is an aluminum / steel tool designed for use in the workshop environment. Version 2 is an economy version of this tool, designed for use in a van or on site and when only a smaller number of shackles needs to be changed. A flat-bladed screwdriver can not be used to remove the shackle.



Professional Aluminum/Steel Tool

**“Easy Shackle Change” Feature**

The popular “Easy Shackle Change” feature has been expanded to all 83AL's, 83/40's, 83/45's, 83KnK/45 SGT, 83/50's and 83WP/53's Series 2.



Solid Steel Tool

**3-in-1 Bolt Driver**

The 3-in-1 bolt driver is used only in our large steel body padlocks. It makes changing shackles a lot easier as the spring does not need to be reset. The 3-in-1 bolt driver is used in the 83/55, 83CS/55, 83/80 and 83WP/63 Series 2 as well as all IC padlocks.



3-in-1 Bolt Driver

**Z-bar**

The Z-bar is used to convert our 83 Series padlocks from key-retaining to non-key-retaining and vice versa within seconds. The Series 2 Z-bar is symmetrical and has a black dot on it, in contrast to the old Z-bar which has a red dot. The old S1 and new S2 Z-bars are not interchangeable.



Z-bar

**C6A Cylinder**

Patented 5-pin to 6-pin conversion. For tremendous time & cost saving.



C6A Cylinder

**K.I.T.™ - Key it Twice (Construction Key)**

Comes with extra pair of keys: If original keys are lost (Key A), use of second pair (Key B) instantly “rekeys” padlock!



Key B  
(different to Key A)

# PLATINUM 34CS

HIGH PROTECTION WITH EXCHANGEABLE CYLINDER



Cylinder Protection

Service Kit



## TECHNOLOGY AND FEATURES







- Precision pin tumbler cylinder
- Body and shackle made from hardened alloy steel
- RK: cylinder can be re-keyed to match an existing key
- Shackle guard protects shackle from attack
- Constructed and tested according to CEN-class 4
- The cylinder cover is available separately

## CARACTÉRISTIQUES TECHNIQUES

- Cylindre de précision à goupilles
- Boîtier et anse en acier spécial, cémenté
- RK : la fermeture peut-être modifiée et adaptée aux fermetures existantes
- Anse blindée: pratiquement inaccessible aux outils d'attaques conventionnels
- Conçu et testé conformément à CEN classe 4
- Un capuchon de protection pour le cylindre est disponible séparément

## CARACTERÍSTICAS TÉCNICAS

- Cilindro de pitones de precisión
- Cuerpo y arco de aleación de acero endurecido
- RK: El cilindro se puede recodificar a una llave existente
- CS: El protector de arco protege el arco contra cualquier ataque
- Construido y probado según CEN Class 4
- La protección del cilindro se vende por separado

Ref. No. Référence Referencia	EAN 4003318	 mm	 mm	 mm	 mm	 mm	 mm	Weight g Poids g Peso g	Key Blank Ébauche Llave en bruto	Level Degré Nivel	Box Quantity Unité d'emballage Cantidad de cajas
34CS/55	20071 7	55	25	28	11	25	87	620	20066	8	3
Cylinder Protection 34/55	30414 9	70				32	25	20			1

## SURCHARGE / MAJORATION / RECARGO

- Keyed alike / S'entrouvrant / Llaves iguales
- Keyed alike as per sample / Fermeture selon échantillon / Cierre según muestra
- up to 49 pcs/jusqu'à 49 pces./hasta 49 pzas.
- as of 50 pcs/à partir de 50 pces./a partir de 50 pzas.



# ROCK 83/80 | 83/60

FOR HIGH SECURITY - KEYED ALIKE WITH THE FRONT DOOR



DIN EN	DIN EN	SBSC	SBSC
12320	12320	KEYPROTECT	KEYPROTECT
KI. 5	KI. 4	KI. 4	KI. 3
83/80 83CS/80	83/60	83/80 83CS/80	83/60



## TECHNOLOGY AND FEATURES

- Shackle and body made of hardened steel
- Shackle made from hardened alloy steel
- Double bolted
- Can be adapted to meet various requirements within seconds - no special tools needed
- 83/60 and 83/80: Key-retaining: Lock retains key until locked
- CS: shackle guard protects shackle from attack
- O: Designed to accept Scandinavian Oval cylinders
- HB100: shackle detachable, particularly suitable for use in ConHasp Granit™ 215
- 60 mm: SSF KI. 3/ CEN KI. 4; 80 mm: SSF KI.4/ CEN KI. 5
- Cylinder cover available upon request

## CARACTÉRISTIQUES TECHNIQUES

- Le cylindre peut être enlevé et adapté à des fermetures existantes
- CS : anse blindée: pratiquement inaccessible aux outils d'attaques conventionnels
- O: Le cadenas peut être équipé de différents types de cylindres tels que le cylindre ovale
- HB100 : haute anse de 100mm, totalement amovible. Peut être combiné avec l'antivol pour container de chantier GRANIT™ 215
- 60 mm: SSF KI. 3/ CEN KI. 4; 80 mm: SSF KI.4/ CEN KI. 5
- Un capuchon de protection pour le cylindre est disponible séparément

## CARACTERÍSTICAS TÉCNICAS

- Arco y cuerpo del candado de acero templado especial
- NANO PROTECT™: protección extrema contra la corrosión del cuerpo del candado y el arco gracias a la nanotecnología
- Bloqueo esférico doble
- Extremadamente flexible: puede adaptarse a los más diversos requisitos rápidamente
- 83/60 y 83/80: bloqueo solo con la llave (la llave no se puede extraer con el candado abierto)
- CS: la protección del arco dificulta el acceso con instrumentos para forzar la apertura
- O: apto para todos los cilindros ovalados disponibles en el mercado
- HB100: arco completamente desmontable, especialmente adecuado para su uso en el candado para contenedores GRANIT™ 215
- 60 mm: SSF KI. 3/ CEN KI. 4; 80 mm: SSF KI.4/ CEN KI. 5
- Protección del cilindro disponible por separado

Ref. No. Référence Referencia	EAN 4003318							Weight g Poids g Peso g	Key Blank Ébauche Llave en bruto	Level Degré Nivel	Box Quantity Unité d'emballage Cantidad de cajas
		mm	mm	mm	mm	mm	mm				
83/60 0 (without cylinder)	51128 8	60	25	38	11	28	105	627		9	6
83/80 0 (without cylinder)	51129 5	80	40	40	15	33	112	1182		10	3
83/60HB60 0 (without cylinder)	51250 6	60	25	60	11	28	128	665		9	3
83/80HB80 0 (without cylinder)	51251 3	80	40	81	15	33	162	1410		10	3
83/80HB100 0 (without cylinder)	51458 6	80	40	100	15	33	182	1493		10	3
83CS/80 0 (without cylinder)	05805 9	80	29	38	15	32	120	1405		10	3
Cylinder Protection 83/60	51104 2	66				22,5	34	19			1
Cylinder Protection 83/80	51105 9	86,5				39	30,5	37			1

# 83/55 | 83CS/55

FOR HIGH SECURITY - KEYED ALIKE WITH THE FRONT DOOR



Cylinder Protection



## TECHNOLOGY AND FEATURES

- Shackle and body made of hardened steel
- Double bolted
- Can be adapted to meet various requirements within seconds - no special tools needed
- 83/55: Patented "Z-Bar" for 2-in-1 function: converts key-retaining to non-key-retaining and vice versa within seconds
- Cylinder cover available upon request

## CARACTÉRISTIQUES TECHNIQUES

- Le cylindre peut être enlevé et adapté à des fermetures existantes
- Anse et corps en acier cémenté
- Double verrouillage
- Peut être adapté aux différentes exigences en quelques secondes - aucun outil spécial n'est nécessaire.
- 83/55: Z-Bar „breveté pour fonction 2 en 1: conversion simple et rapide du principe de clé non-prisonnière au principe de clé prisonnière“
- Un capuchon de protection pour le cylindre est disponible séparément

## CARACTERÍSTICAS TÉCNICAS

- Arco y cuerpo del candado de acero templado especial
- Bloqueo esférico doble
- Extremadamente flexible: puede adaptarse a los más diversos requisitos rápidamente
- 83/55: Según su preferencia: bloqueo automático = bloqueo sin llave presionando el arco, o bien cierre forzado = bloqueo solo con llave (barra Z)
- CS: la protección del arco dificulta el acceso con instrumentos para forzar la apertura
- Protección del cilindro disponible por separado

Ref. No. Référence Referencia	EAN 4003318							Weight g Poids g Peso g	Key Blank Ébauche Llave en bruto	Level Degré Nivel	Box Quantity Unité d'emballage Cantidad de cajas
		mm	mm	mm	mm	mm	mm				
83/55	52462 2	55	26	37	11,5	25	103	625	10023	9	6
83/55 (without cylinder)	53225 2	55	26	37	11,5	25	103	520		9	6
83CS/55	52463 9	55	26	28	11,5	25	94	675	10023	9	6
83CS/55 (without cylinder)	52568 1	55	26	28	11,5	25	94	573		9	6
Cylinder 83 EC550 3-bitted w/o keys	76945 0										1
Cylinder 83 EC550 KD	54774 4										1
Cylinder A93 1-bitted w/o keys	89484 8										1
Cylinder A93 KD	89485 5										1
Cylinder Protection 83/55	30414 9	70				32	25	18			6

## SURCHARGE / MAJORATION / RECARGO

- Keyed alike / S'entrouvrant / Llaves iguales
- Keyed alike as per sample / Fermeture selon échantillon / Cierre según muestra
- Master key function / Clé passe / Funcion llave maestra

# 83WP | 83WPCS

FOR HIGHEST SECURITY - WEATHER PROTECTED



83WP/63



## TECHNOLOGY AND FEATURES

- Shackle and lock body made of hardened special steel with NANO PROTECT™ coating for extreme corrosion resistance
- Precision pin cylinder
- RK: cylinder can be re-keyed to match an existing key
- As required, either automatic locking = locking without a key by pressing down on the shackle, or key-retaining = locking only with a key (Z-bar)
- Extremely weather-resistant due to the full plastic coating, including cylinder protection and sealed shackle holes
- 83WP/53: Shackle can be exchanged within seconds

## CARACTÉRISTIQUES TECHNIQUES

- Boîtier en acier cémenté avec technologie NANO PROTECT™
- Cylindre de précision à goupilles avec fenêtre de remplissage
- RK : Le cylindre peut être enlevé et adapté à des fermetures existantes
- Z-Bar™ breveté pour fonction 2 en 1 : conversion simple et rapide du principe de clé non-prisonnière au principe de clé
- Gaine en matière plastique résistant aux coups avec canaux de drainage
- 83WP/53 : changement facile de l'anse, l'anse peut être changée dans l'espace de quelques secondes

## CARACTERÍSTICAS TÉCNICAS

- Cuerpo y arco de acero endurecido con recubrimiento de NANO PROTECT™ para una gran resistencia a la corrosión
- Cilindro de gran precisión de pitones con apertura de pitones patentada
- RK: Se puede extraer el cilindro y modificar el cierre para la llave existente
- Z-bar™ patentado con función 2 en 1: convierte el sistema de llave retenida en no retenida y viceversa en unos segundos
- Tapa duradera de protección contra la intemperie con sistema de drenaje
- 83WP/53: Arco fácil de cambiar: el arco se puede cambiar en unos segundos

Ref. No. Référence Referencia	EAN 4003318							Weight g Poids g Peso g	Key Blank Ébauche Llave en bruto	Level Degré Nivel	Box Quantity Unité d'emballage Cantidad de cajas
		mm	mm	mm	mm	mm	mm				
83WP/53	52936 8	52	25	28	8	29	97	371	10023	8	6
83WP/63	52937 5	65	25	35,5	11	34	112	526	10023	9	6
83WP/53 (without cylinder)	53227 6	57	23,5	28	8	34	97	303		8	6
83WP/63 (without cylinder)	53228 3	65	25	35,5	11	34	112	424		9	3
83WPCS/53	57131 2	57	18,5	24	8	34,5	97	420	10023	8	6
83WPCS/53 (without cylinder)	52569 8	56,5	18	24,5	8	34	97	435		8	6
Cylinder 83 EC550 3-bitted w/o keys	76945 0										1
Cylinder 83 EC550 KD	54774 4										1
Cylinder A93 1-bitted w/o keys	89484 8										1
Cylinder A93 KD	89485 5										1

## SURCHARGE / MAJORATION / RECARGO

- Keyed alike / S'entrouvrant / Llaves iguales
- Keyed alike as per sample / Fermeture selon échantillon / Cierre según muestra
- Master key function / Clé passe / Funcion llave maestra

# 83WPIB

EXTREMELY WEATHER PROTECTED



## TECHNOLOGY AND FEATURES

- Lock body made of solid brass
- Stainless-steel shackle
- As required, either automatic locking = locking without a key by pressing down on the shackle, or key-retaining = locking only with a key (Z-bar)
- Extremely weather-resistant due to the full plastic coating, including cylinder protection and sealed shackle holes; drainage channels transport moisture that has penetrated the lock back out
- Shackle can be exchanged within seconds
- RK: cylinder can be re-keyed to match an existing key

## CARACTÉRISTIQUES TECHNIQUES

- Boîtier en laiton massif, spécialement chromé - anse revêtue d'un gainage anti-corrosion et cache-entrée de clé
- Anse en acier INOX
- Z-Bar" breveté pour fonction 2 en 1 : conversion simple et rapide du principe de clé non-prisonnière au principe de clé prisonnière"
- Cylindre de précision à goupilles avec fenêtre de remplissage
- Changement facile de l'anse, l'anse peut être changée dans l'espace de quelques secondes
- RK : la fermeture peut-être modifiée et adaptée aux fermetures existantes

## CARACTERÍSTICAS TÉCNICAS

- Cuerpo de latón
- Arco de acero inoxidable
- Z-bar" patentado con función 2 en 1: convierte el sistema de llave retenida en no retenida y viceversa en unos segundos"
- Tapa duradera de protección contra la intemperie con sistema de drenaje
- Cambio fácil del arco: el arco se puede cambiar en pocos segundos
- RK: Se puede extraer el cilindro y modificar el cierre para la llave existente

Ref. No. Référence Referencia	EAN 4003318	mm	mm	mm	mm	mm	Weight g Poids g Peso g	Key Blank Ébauche Llave en bruto	Level Degré Nivel	Box Quantity Unité d'emballage Cantidad de cajas	
83WPIB/53	52938 2	57	24	28	8	35	103	345	10023	8	6
83WPIB/53 (without cylinder)	52570 4	57	24	28	8	35	103	274	8	6	
Cylinder 83 EC550 3-bitted w/o keys	76945 0										1
Cylinder 83 EC550 KD	54774 4										1
Cylinder A93 1-bitted w/o keys	89484 8										1
Cylinder A93 KD	89485 5										1

## SURCHARGE / MAJORATION / RECARGO

- Keyed alike / S'entrouvrant / Llaves iguales
- Keyed alike as per sample / Fermeture selon échantillon / Cierre según muestra
- Master key function / Clé passe / Funcion llave maestra



### TECHNOLOGY AND FEATURES

- Chrome plated solid brass lock body
- Special alloy steel shackle with NANO PROTECT™ coating for extra corrosion resistance
- High precision pin tumbler cylinder with patented pinning window
- Patented "Z-Bar" for 2-in-1 function: converts key-retaining to non-key-retaining and vice versa within seconds
- Cylinder can be taken out and can be re-keyed to match an existing key
- RK: Can be keyed into many popular security keyways
- Easy shackle change: shackle can be exchanged within seconds

### CARACTÉRISTIQUES TECHNIQUES

- Boîtier en laiton chromé
- Anse en acier spécial cémenté avec technologie NANO PROTECT™
- Cylindre de précision à goupilles avec fenêtre de remplissage
- Z-Bar" breveté pour fonction 2 en 1 : conversion simple et rapide du principe de clé non-prisonnière au principe de clé prisonnière"
- Le cylindre peut être enlevé et adapté à des fermetures existantes
- RK: Compatible avec de nombreux profils de clé, peut être intégré dans des systèmes de fermeture existants
- Changement facile de l'anse, l'anse peut-être changée en quelques secondes

### CARACTERÍSTICAS TÉCNICAS

- Cuerpo del candado de latón macizo cromado
- Arco de acero templado especial con revestimiento NANO-PROTECT™ para una máxima protección contra la corrosión
- Cilindro de perno de precisión
- Según su preferencia: bloqueo automático = bloqueo sin llave presionando el arco, o bien cierre forzado = bloqueo solo con llave (barra Z)
- Cilindro intercambiable
- RK: el cilindro puede adaptarse a los cierres existentes
- El arco se puede cambiar en cuestión de segundos

Ref. No. Référence Referencia	EAN 4003318							Weight g Poids g Peso g	Key Blank Ébauche Llave en bruto	Level Degré Nivel	Box Quantity Unité d'emballage Cantidad de cajas
		mm	mm	mm	mm	mm	mm				
83/50	52461 5	48	24	27	9,5	21	88	390	10023	8	6
83/50 (without cylinder)	53223 8	48	24	27	9,5	21	88	292		8	6
83CS/50	57114 5	48	22	27	9,5	21	88	410	10023	8	6
83CS/50 (without cylinder)	53224 5	48	22	27	9,5	21	88	333		8	6
Cylinder 83 EC550 3-bitted w/o keys	76945 0										
Cylinder 83 EC550 KD	54774 4										
Cylinder A93 1-bitted w/o keys	89484 8										
Cylinder A93 KD	89485 5										

### SURCHARGE / MAJORATION / RECARGO

- Keyed alike / S'entrouvrant / Llaves iguales
- Keyed alike as per sample / Fermeture selon échantillon / Cierre según muestra
- Master key function / Clé passe / Funcion llave maestra

# 83/45 | 83/40

HIGH SECURITY - KEYED ALIKE WITH THE FRONT DOOR

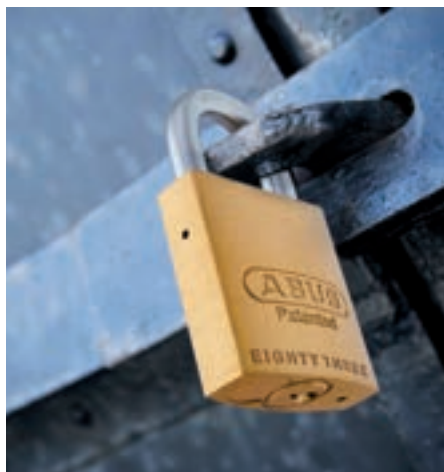

Cylinder Protection



## TECHNOLOGY AND FEATURES

- Chrome plated solid brass lock body
- Special alloy steel shackle with NANO PROTECT™ coating for extra corrosion resistance
- High precision pin tumbler cylinder with patented pinning window
- Patented "Z-Bar" for 2-in-1 function: converts key-retaining to non-key-retaining and vice versa within seconds
- Cylinder can be taken out and can be re-keyed to match an existing key
- RK: Can be keyed into many popular security keyways
- Easy shackle change: shackle can be exchanged within seconds

## CARACTÉRISTIQUES TECHNIQUES

- Boîtier en laiton chromé
- Anse en acier spécial cémenté avec technologie NANO PROTECT™
- Cylindre de précision à goupilles avec fenêtre de remplissage
- "Z-Bar" breveté pour fonction 2 en 1 : conversion simple et rapide du principe de clé non-prisonnière au principe de clé prisonnière"
- Le cylindre peut être enlevé et adapté à des fermetures existantes
- RK: Compatible avec de nombreux profils de clé, peut être intégré dans des systèmes de fermeture existants
- Changement facile de l'anse, l'anse peut-être changée en quelques secondes

## CARACTERÍSTICAS TÉCNICAS

- Cuerpo del candado de latón macizo cromado
- Arco de acero templado especial con revestimiento NANO-PROTECT™ para una máxima protección contra la corrosión
- Cilindro de perno de precisión
- Según su preferencia: bloqueo automático = bloqueo sin llave presionando el arco, o bien cierre forzado = bloqueo solo con llave (barra Z)
- Cilindro intercambiable
- RK: el cilindro puede adaptarse a los cierres existentes
- El arco se puede cambiar en cuestión de segundos

Ref. No. Référence Referencia	EAN 4003318							Weight g Poids g Peso g	Key Blank Ébauche Llave en bruto	Level Degré Nivel	Box Quantity Unité d'emballage Cantidad de cajas
		mm	mm	mm	mm	mm	mm				
83/45	52460 8	47	23,5	26,5	8	21	85	356	10023	8	1
83/45 (without cylinder)	53222 1	47	23,5	26,5	8	21	85	266		8	1
Cylinder 83 EC550 3-bitted w/o keys	76945 0										1
Cylinder 83 EC550 KD	54774 4										1
Cylinder A93 1-bitted w/o keys	89484 8										1
Cylinder A93 KD	89485 5										1
Cylinder Protection 83/45	27347 6	60				27	23	14			12

## SURCHARGE / MAJORATION / RECARGO

- Keyed alike / S'entrouvrant / Llaves iguales
- Keyed alike as per sample / Fermeture selon échantillon / Cierre según muestra
- Master key function / Clé passe / Funcion llave maestra

# 83S/45LFIC

BEST REKEYABLE EVER - LARGE FORMAT INTERCHANGEABLE CORE



## TECHNOLOGY AND FEATURES

- Body and shackle made of chrome-plated hardened steel with extra NANO PROTECT™ coating for more corrosion resistance
- Patented "Z-bar" for 2-in-1 function: converts key-retaining to non-key-retaining and vice versa within seconds
- Easy Shackle Change: Shackle can be exchanged within seconds
- Accepts Large Format Interchangeable Core (LFIC) cylinders
- Double stainless steel ball deadlocking mechanism for high tensile and torsion strength
- Key-retaining only

## CARACTÉRISTIQUES TECHNIQUES

- Boîtier et anse en acier cémenté et chromé avec technologie NANO PROTECT™ pour une haute protection anti-corrosion
- "Z-bar" breveté pour fonction 2 en 1: pour changer rapidement du principe clé non-prisonnière au principe clé prisonnière - tout simplement
- Changement facile de l'anse, l'anse peut être changée dans l'espace de quelques secondes
- Accepte des cylindres de grand format (LFIC)

## CARACTERÍSTICAS TÉCNICAS

- Cuerpo y arco de acero endurecido con recubrimiento de NANO PROTECT™ para una gran resistencia a la corrosión
- Cilindro de gran precisión de pitones con apertura de pitones patentada
- RK: Se puede extraer el cilindro y modificar el cierre para la llave existente
- Z-bar" patentado con función 2 en 1: convierte el sistema de llave retenida en no retenida y viceversa en unos segundos"
- Tapa duradera de protección contra la intemperie con sistema de drenaje
- 83WP/53: Arco fácil de cambiar: el arco se puede cambiar en unos segundos

Ref. No. Référence Referencia	EAN 4003318	mm	mm	mm	mm	mm	Weight g Poids g Peso g	Key Blank Ébauche Llave en bruto	Level Degré Nivel	Box Quantity Unité d'emballage Cantidad de cajas
83S/45 LFIC	86800 9	44,5	23,5	30	8	19	93	378	8	6

## SURCHARGE / MAJORATION / RECARGO

- Keyed alike / S'entrouvrant / Llaves iguales
- Keyed alike as per sample / Fermeture selon échantillon / Cierre según muestra
- Master key function / Clé passe / Funcion llave maestra

# 83AL TITALIUM™

HIGH SECURITY - ANODIZED ALUMINIUM



83AL/40 black



83AL/40 blue



83AL/40 green



83AL/40 red



83AL/40 yellow



83AL/45 silver



## TECHNOLOGY AND FEATURES







- Lock body made from TITALIUM™ special aluminium - high security with low weight
- Hardened special steel shackle with NANO PROTECT™ coating for very high corrosion resistance
- Patented Z-Bar™ for 2 in 1 function: converts key retaining to non-key retaining and vice versa in seconds"
- Cylinder can be taken out and can be re-keyed to match an existing key
- RK: Can be keyed into many popular security keyways

## CARACTÉRISTIQUES TECHNIQUES

- Boîtier en aluminium ultra-léger, anodisé couleur
- Anse en acier spécial cémenté avec technologie NANO PROTECT™, également disponible en version laiton et acier INOX disponible en différentes hauteurs
- Z-Bar™ breveté pour fonction 2 en 1 : conversion simple et rapide du principe de clé non-prisonnière au principe de clé prisonnière"
- Le cylindre peut être enlevé et adapté à des fermetures existantes
- RK: Compatible avec de nombreux profils de clé, peut être intégré dans des systèmes de fermetures existants

## CARACTERÍSTICAS TÉCNICAS

- Cuerpo del candado de aluminio especial TITALIUM™ – alta seguridad con un peso reducido
- Arco de acero templado especial con revestimiento NANO-PROTECT™ para una máxima protección contra la corrosión
- Según su preferencia: bloqueo automático = bloqueo sin llave presionando el arco, o bien cierre forzado = bloqueo solo con llave (barra Z)
- Cilindro intercambiable
- RK: el cilindro puede adaptarse a los cierres existentes

Ref. No. Référence Referencia	EAN 4003318	 mm	 mm	 mm	 mm	 mm	 mm	Weight g Poids g Peso g	Key Blank Ébauche Llave en bruto	Level Degré Nivel	Box Quantity Unité d'emballage Cantidad de cajas
83AL/40 blue vs.	38935 1	40	23	38	6,5	19	97	215	72477	7	6
83AL/40 yellow vs.	38938 2	40	23	38	6,5	19	97	215	72477	7	6
83AL/40 green vs.	38941 2	40	23	38	6,5	19	97	215	72477	7	6
83AL/40 red vs.	38944 3	40	23	38	6,5	19	97	215	72477	7	6
83AL/40 black vs.	38947 4	40	23	38	6,5	19	97	215	72477	7	6
83AL/40 silver vs.	38950 4	40	23	38	6,5	19	97	215	72477	7	6
83AL/40 black (without cylinder)	55026 3	40	23	38	6,5	19	97	179		7	6
83AL/40 blue (without cylinder)	55029 4	40	23	38	6,5	19	97	179		7	6
83AL/40 green (without cylinder)	55028 7	40	23	38	6,5	19	97	179		7	6
83AL/40 red (without cylinder)	55027 0	40	23	38	6,5	19	97	179		7	6
83AL/40 yellow (without cylinder)	55030 0	40	23	38	6,5	19	97	179		7	6
83AL/40 silver (without cylinder)	55031 7	40	23	38	6,5	19	97	179		7	6
83AL/45 silver (without cylinder)	59475 5	47	24	25	8	21	85	204		8	6
Cylinder 83 EC550 3-bitted w/o keys	76945 0										1
Cylinder 83 EC550 KD	54774 4										1
Cylinder A93 1-bitted w/o keys	89484 8										1
Cylinder A93 KD	89485 5										1

## SURCHARGE / MAJORATION / RECARGO

- Keyed alike / S'entrouvrant / Llaves iguales
- Keyed alike as per sample / Fermeture selon échantillon / Cierre según muestra
- Master key function / Clé passe / Funcion llave maestra



FOR HIGHEST SECURITY

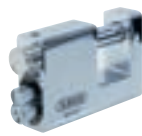

Product Video

DIN EN  
12320  
Kl. 6



Kl. 5



### TECHNOLOGY AND FEATURES

- Shackle and lock body made of hardened special steel with NANO PROTECT™ coating for extra corrosion resistance
- Protected against drilling or pulling open
- Cylinder can be replaced and re-keyed to match an existing key
- 0: Accepts all standard oval cylinders
- EPZ: Accepts all standard Euro profile half cylinders
- fig. 8: Accepts all cylinders from the ABUS 83 series

### CARACTÉRISTIQUES TECHNIQUES

- Anse et boîtier du cadenas en acier spécial trempé avec revêtement NANO PROTECT™ pour une protection optimale contre la corrosion
- Protection anti-perçage et anti-arrachement
- Le cylindre est interchangeable et peut être adapté aux fermetures existantes
- 0: Réception possible de tous les cylindres ovales de modèle courant
- EPZ: Réception possible de tous les demi-cylindres à profil européen de modèle courant
- fig. 8: Réception possible de tous les cylindres de la série ABUS 83

### CARACTERÍSTICAS TÉCNICAS

- Arco y cuerpo del candado de acero especial reforzado con revestimiento NANO PROTECT™ para una protección extra contra la corrosión
- Protección antitaladro y antiextracción
- El cilindro se puede cambiar para adaptarse a la instalación de cierre existente
- 0: Posibilidad de alojar todos los cilindros ovalados habituales en el mercado
- EPZ: Posibilidad de alojar todos los medios cilindros de perfil europeo habituales en el mercado
- fig. 8: Posibilidad de alojar todos los cilindros de la serie 83 de ABUS

Ref. No. Référence Referencia	EAN 4003318							Weight g Poids g Peso g	Key Blank Ébauche Llave en bruto	Level Degré Nivel	Box Quantity Unité d'emballage Cantidad de cajas
		mm	mm	mm	mm	mm	mm				
93RK/100 (without cylinder)	89010 9	100	34,5	21,5	15	29	70	1159		10	3
93RK/110 EPZ (without cylinder)	88993 6	110	34,5	21,5	15	29	70	1210		10	3
93RK/110 0 (without cylinder)	88994 3	110	34,5	21,5	15	29	70	1202		10	3

### SURCHARGE / MAJORATION / RECARGO

- Keyed alike / S'entrouvrant / Llaves iguales

# 183AL/45

HIGH SECURITY - IDEAL FOR OUTDOOR USE



Product Video



## TECHNOLOGY AND FEATURES







- Solid aluminium lock body
- 5-digit number code – can be individually set
- Interchangeable shackle in different heights and materials: Heights: HB19, HB25, HB38, HB 50, HB75, HB100 Materials: IB (stainless steel), MB (brass), SA (steel)
- Double bolted shackle
- Number dials and internal components made of stainless steel for greater corrosion resistance
- Precision locking mechanism – greater protection against picking

## CARACTÉRISTIQUES TECHNIQUES

- Corps de cadenas en aluminium massif
- Code à 5 chiffres, réglable individuellement
- Anse interchangeable, disponible en plusieurs hauteurs et matériaux : Hauteurs : HB19, HB25, HB38, HB50, HB75, HB100 Matériaux : IB (acier inoxydable), MB (laiton), SA (acier)
- Double verrouillage de l'anse
- Molettes à chiffres et pièces intérieures en acier inoxydable pour une meilleure résistance à la corrosion
- Mécanisme de fermeture précis pour une protection accrue contre le crochitage

## CARACTERÍSTICAS TÉCNICAS

- Cuerpo del candado de aluminio macizo
- Código numérico de 5 cifras personalizable
- Arco intercambiable en diferentes alturas y materiales: Alturas: HB19, HB25, HB38, HB 50, HB75, HB100 Materiales: IB (acero inoxidable), MB (latón), SA (acero)
- Bloqueo doble de arco
- Rodillos numéricos y piezas interiores de acero inoxidable para una mayor resistencia a la corrosión
- Mecanismo de cierre de precisión: mayor protección al forzado

Ref. No. Référence Referencia	EAN 4003318	 mm	 mm	 mm	 mm	 mm	 mm	Weight g Poids g Peso g	Key Blank Ébauche Llave en bruto	Level Degré Nivel	Box Quantity Unité d'emballage Cantidad de cajas
183AL/45	88699 7	47	24	26	8	20	109	226		8	6
183AL/45 B/EFSP	40487 0	47	24	26	8	20	109	235		8	6

# 90RK/50 TITALIUM™

CLOSE SHACKLE SECURITY AND INDIVIDUAL SERVICE FROM ABUS



## TECHNOLOGY AND FEATURES







- Lock body made from TITALIUM™, a special aluminium alloy: high security at low weight
- Shackle made from high quality stainless steel, double bolted: high resistance against pulling and torsion
- With integrated shackle guard to protect against bolt cutter attacks
- Extreme corrosion resistance
- Precision pin cylinder
- Interchangeable cylinder: if required, the lock can also be adapted to existing locks
- Key retaining: key is needed for locking (lock retains key until locked)

## CARACTÉRISTIQUES TECHNIQUES

- Boîtier massif en aluminium spécial TITALIUM™: poids léger, sûreté élevée
- Anse en acier inoxydable, double verrouillage de l'anse : haute résistance contre toute sorte d'attaques telles que l'extraction et la torsion
- Anse blindée : haute résistance au coupe boulon
- Anticorrosion très élevée
- Cylindre de précision à pistons
- Echange facile et rapide du cylindre
- Avec fonction clé-prisonnière : la clé est obligatoire pour le verrouillage du cadenas et ne peut être retirée qu'en position verrouillée

## CARACTERÍSTICAS TÉCNICAS

- Cuerpo de candado fabricado en TITALIUM™, una sólida aleación de aluminio: mayor seguridad, menor peso
- Arco de acero inoxidable de alta calidad
- Protección de planchado integrado
- Protegidos contra la corrosión
- Cilindro de pitones de precisión
- Cilindro intercambiable: la cerradura se puede adaptar a las cerraduras existentes
- Llave retenida: Sólo se podrá cerrar con la llave (la llave se queda en el candado hasta que éste haya sido cerrado)

Ref. No. Référence Referencia	EAN 4003318	 mm	 mm	 mm	 mm	 mm	 mm	Weight g Poids g Peso g	Key Blank Ébauche Llave en bruto	Level Degré Nivel	Box Quantity Unité d'emballage Cantidad de cajas
90RK/50	55292 2	50	20	22,5	9,5	23	81	264	10023	8	6
90RK/50 B/EFSP	55902 0	50	20	22,5	9,5	23	81	264	10023	8	6

## SURCHARGE / MAJORATION / RECARGO

- Keyed alike / S'entrouvrant / Llaves iguales
- Keyed alike as per sample / Fermeture selon échantillon / Cierre según muestra
- up to 49 pcs/jusqu'à 49 pces./hasta 49 pzas.
- as of 50 pcs/à partir de 50 pces./a partir de 50 pzas.





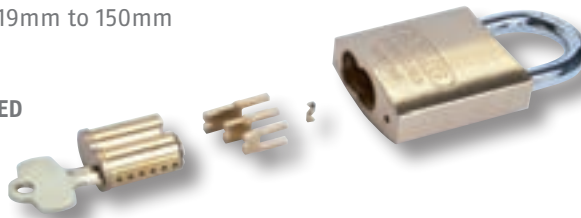

# INTERCHANGEABLE CORE PADLOCKS

## 83 Interchangeable Core Features

- The lock series works with 5-pin, 6-pin and 7-pin small format cylinders (SFIC) as well as large format cylinders (LFIC)
- Available in solid brass, solid brass chrome-plated, solid hardened steel and solid aluminum bodied padlocks
- Hardened steel shackle with NANO PROTECT™ plating for extreme corrosion resistance
- 3-in-1 bolt driver makes it easy to change shackles as the spring does not need to be reset
- Patented "Z-bar" allows padlock to be easily converted from non-key-retaining to key-retaining in seconds
- Shackle available in a choice of materials – NANO PROTECT™ plated steel, stainless steel and brass
- Shackle available in a range of sizes from 19mm to 150mm

### ALL DRIVERS INCLUDED



Ref.-No. Référence Referencia	 mm	 mm	 mm	 mm	 mm	 mm	Locking elements Eléments fem. Compo. de cierre	Weight / g Poids / g Peso / g	Level Niveau Nivel	Quantity Boxed Quantité Boite Cantidad Caja	Quantity Carded Quantité Carte Cantidad Tarjeta
83AL-IC/40	40	23	38	6,5	19	97	-	76	8	6	-
83AL-IC/45	47	24	25	8	21	84	-	130	9	6	-
83CS-IC/45	47	22	26	8	21	84	-	295	8	6	-
83IC/45	47	24	25	8	21	84	-	266	8	6	-
83CS-IC/50	48	24	27	9	21	87	-	330	8	6	-
83IC/50	48	24	27	9	21	88	-	292	8	6	-
83WP-IC/53	52	25	28	8	29	97	-	280	9	6	-
83CS-IC/55	52	26	25	11	25	94	-	576	8	6	-
83IC/55	55	26	37	11	25	104	-	534	8	3	-
83WP-IC/63	60	25	35	11	30	106	-	424	8	6	-
83S/45 LFIC	44,5	23,5	30	8	19	93	-	282	8	6	-
83WP-LFIC/53	57	23,5	28	8	34	97	-	303	8	6	-

## ABUS 888 KEYWAY

ABUS's new key-restricted system, the ABUS 888 keyway, provides key control and protection against unauthorized duplication of keys and offers increased security. The extra strong key with its high torsion resistance is 4x stronger than most OEM keyways.



## SHACKLE COLLAR



With an ABUS shackle collar and chain, you can affix any one of our 83 series padlocks to a specific location to help prevent loss and contamination of the padlock. The shackle collar slides up the leg of the shackle and keeps the chain attached to the padlock when open.



8mm



10mm



11mm

# DOUBLE SHACKLE FEATURE

The 83AL/50 padlock is available in a very special version with two straight shackles. Having two separate shackles and two 83AL/50 bodies, the lock can easily be used by two people with different keys. As a special feature of the 83 Series®, it is even possible to use two different cylinders from different manufacturers. The double shackle lock is therefore ideal for industries with multiple work shifts or with lots of maintenance work.



# ABUS DISKUS



20



26 / 26WY



25



24 / 24RK



24IB / 24IBWY



28



220

	20	26 / 26WY	25	24 / 24RK	24IB / 24IBWY	28	220
<b>Shackle Material</b>	stainless steel	hardened alloy steel	hardened steel	hardened alloy steel	hardened alloy steel	hardened steel	hardened steel
<b>Body Material</b>	stainless steel	stainless steel	stainless steel	stainless steel	stainless steel	stainless steel	stainless steel
<b>ABUS-Plus cylinder</b>	yes	-	-	-	-	-	-
<b>Drill and pull resistant cylinder</b>	yes	yes	-	-	-	-	-
<b>Cylinder nickel-plated</b>	yes	yes	yes	yes	yes	yes	-
<b>Additional saw protection</b>	yes	yes	yes	yes	yes	yes	-
<b>Code Card</b>	yes	-	yes	-	-	-	-
<b>Locking only with key</b>	yes	yes	yes	yes	yes	yes	yes
<b>Made in Germany</b>	yes	yes	yes	yes	yes	yes	yes

# DISKUS® 20

ORIGINAL ABUS DISKUS WITH ABUS PLUS LOCKING SYSTEM



Product Video



## TECHNOLOGY AND FEATURES

- Stainless steel - outside and inside
- Additional protection against sawing
- Shackle made from high quality stainless steel
- ABUS-Plus disc cylinder: highest protection against manipulation, extremely high number of key differs
- Cylinder cover – maximum protection against dirt and water spray
- Sophisticated Diskus® welded seam for highest break resistance
- Original Diskus® design: 360° protection
- Key retaining: key is needed for locking (lock retains key until locked)
- Made in Germany
- 2 keys

## CARACTÉRISTIQUES TECHNIQUES

- Acier inoxydable - à l'intérieur et à l'extérieur
- Protection supplémentaire contre les scies
- Anse en acier trempé spécial
- Cylindre à disque ABUS Plus: précision maximale contre les manipulations, nombre de fermetures extrêmement élevé
- Masquage des cylindres - protection maximale contre la saleté et les projections d'eau
- Technologie de soudage Diskus® - la meilleure protection contre les effractions
- Original Diskus® design: protection à 360°
- Fermeture obligatoire: verrouillage uniquement avec la clé (la clé ne peut pas être retirée quand le cadenas est ouvert)
- Made in Germany
- Deux clés incluses

## CARACTERÍSTICAS TÉCNICAS

- Acero inoxidable: Interior y exterior
- Placa anti-cizallamiento
- Arco fabricado de acero endurecido
- Cilindro de disco ABUS-PLUS: Máxima protección contra manipulación, antitaladro y anti-torsión
- Tapa para cubrir el cilindro y protegerlo de la suciedad y la humedad (60 y 70 mm)
- Tecnología de Soldadura Profunda Diskus® - robustez máxima
- Diseño original Diskus®: protección en 360°
- Llave retenida: Sólo se podrá cerrar con la llave (la llave se queda en el candado hasta que éste haya sido cerrado)
- Fabricado en Alemania
- 2 llaves

Ref. No. Référence Referencia	EAN 4003318							Weight g Poids g Peso g	Key Blank Ébauche Llave en bruto	Level Degré Nivel	Box Quantity Unité d'emballage Cantidad de cajas
		mm	mm	mm	mm	mm	mm				
20/70	08854 4	70	20	17	10	30	70	337	05078	9	6
20/80	08798 1	80	25	18	11	35	81	469	05078	9	3
20/70 B/EFSP	32164 1	70	20	17	10	30	70	337	05078	9	6
20/80 B/EFSP	32165 8	80	25	18	11	35	81	469	05078	9	3
20/70 vs. Lock-Tag	81697 0	70	20	17	10	30	70	330	05078	9	6
20/80 vs. Lock-Tag	81696 3	80	25	18	11	35	81	466	05078	9	3
Master Key ABUS-PLUS	04325 3										1

## SURCHARGE / MAJORATION / RECARGO

- Keyed alike / S'entrouvrant / Llaves iguales
- Keyed alike as per sample / Fermeture selon échantillon / Cierre según muestra
- Master key function / Clé passe / Funcion llave maestra

# DISKUS® 26 | 26WY

ORIGINAL ABUS DISKUS - SOLID SECURITY



More Information



## TECHNOLOGY AND FEATURES

- Heavy-duty stainless steel body
- Massive inner base for enhanced security
- Additional protection against sawing
- Shackle made from special alloy hardened steel
- Drill and pull resistant cylinder
- Diskus® Deep-Welding Technology - maximum strength
- Original Diskus® design: 360° protection
- Key retaining: key is needed for locking (lock retains key until locked)
- Made in Germany

## CARACTÉRISTIQUES TECHNIQUES

- Boîtier lourd en acier inoxydable
- Ouvrage intérieur massif pour encore plus de sécurité
- Protection supplémentaire contre les scies
- Anse en acier trempé spécial
- Cylindre protégé contre le perçage et l'arrachement
- Technique de soudage Diskus® - Résistance maximale
- Original Diskus® design : protection à 360°
- Fermeture obligatoire : verrouillage uniquement avec la clé (la clé ne peut pas être retirée quand le cadenas est ouvert)
- Made in Germany

## CARACTERÍSTICAS TÉCNICAS

- Cuerpo de acero inoxidable reforzado
- Interior sólido para aún más seguridad
- Palanca anti-cizallamiento
- Arco de acero de aleación endurecido
- Cilindro de pitones de precisión, con protección anti-taladro y anti-estiramiento
- Tecnología de Soldadura Profunda Diskus® - robustez máxima
- Diseño original Diskus: protección en 360°
- Llave retenida: Sólo se podrá cerrar con la llave (la llave se queda en el candado hasta que éste haya sido cerrado)
- Fabricado en Alemania

Ref. No. Référence Referencia	EAN 4003318							Weight g Poids g Peso g	Key Blank Ébauche Llave en bruto	Level Degré Nivel	Box Quantity Unité d'emballage Cantidad de cajas
		mm	mm	mm	mm	mm	mm				
26/70	12790 8	71	19,5	17	10	30	71	325	12874	8	6
26/80	20335 0	81	25	18	11	31	81	452	12874	8	3
26/90	20340 4	91	25	16	12	29	91	633	12874	8	3
26/70 B/EFSP	32178 8	71	19,5	17	10	30	71	325	12874	8	6
26/80 B/EFSP	35050 4	81	25	18	11	31	81	452	12874	8	3
26WY/70 with 4 keys	82337 4	70	20	17	10	29	70	419	82329	8	6
26WY/80 with 4 keys	82344 2	70	20	17	10	29	70	593	82329	8	6
26/70 Lock-Tag	81701 4	71	19,5	17	10	30	71	403	12874	8	6
26/80 Lock-Tag	81692 5	81	25	18	11	31	81	570	12874	8	3
26/90 Lock-Tag	81703 8	91	25	16	12	29	91	640	12874	8	3
Master Key	02745 1										1

## SURCHARGE / MAJORATION / RECARGO

- Keyed alike / S'entrouvrant / Llaves iguales
- Keyed alike as per sample / Fermeture selon échantillon / Cierre según muestra
- up to 49 pcs/jusqu'à 49 pces./hasta 49 pzas.
- as of 50 pcs/à partir de 50 pces./a partir de 50 pzas.
- Master key function / Clé passe / Funcion llave maestra





Product Video



### TECHNOLOGY AND FEATURES

- High precision reversible key with 8,000 key differs
- Coded keys, spare keys can only be ordered with the code
- Stainless steel - inside and outside
- Hardened steel shackle
- Original Diskus® design: 360° protection
- Additional sawing protection
- Sophisticated Diskus® welded seam for highest break resistance
- Key retaining: key is needed for locking (lock retains key until locked)
- Will be supplied with 5 keys
- Made in Germany
- With Code Card

### CARACTÉRISTIQUES TECHNIQUES

- Cylindre à clé réversible de haute précision avec 8 000 serrures différentes
- Clé codée : commande ultérieure de clé possible d'après le code
- Acier inoxydable - à l'intérieur et à l'extérieur
- Anse en acier trempé
- Original Diskus® design : protection à 360°
- Protection supplémentaire contre les scies
- Technologie de soudage Diskus® - la meilleur protection contre les effractions
- Fermeture obligatoire : verrouillage uniquement avec la clé (la clé ne peut pas être retirée quand le cadenas est ouvert)
- 5 clés incluses
- Made in Germany
- Avec une carte code

### CARACTERÍSTICAS TÉCNICAS

- Llave reversible de precisión con 8,000 combinaciones
- Llaves codificadas, las llaves suplementarias sólo se pueden pedir presentando la tarjeta de seguridad
- Acero inoxidable: Interior y exterior
- Arco de acero endurecido
- Diseño original Diskus®: protección 360°
- Palanca anti-cizallamiento
- Tecnología de Soldadura Profunda Diskus® - robustez máxima
- Llave retenida: Sólo se podrá cerrar con la llave (la llave se queda en el candado hasta que éste haya sido cerrado)
- Se suministra con 5 llaves
- Made in Germany
- Code Card

Ref. No. Référence Referencia	EAN 4003318							Weight g Poids g Peso g	Key Blank Ébauche Llave en bruto	Level Degré Nivel	Box Quantity Unité d'emballage Cantidad de cajas
		mm	mm	mm	mm	mm	mm				
25/70	32279 2	71	19,5	17	10	30	71	323	26423	8	6
25/70 B/EFSP	32280 8	71	19,5	17	10	30	71	323	26423	8	3

### SURCHARGE / MAJORATION / RECARGO

- Keyed alike / S'entrouvrant / Llaves iguales
- Keyed alike as per sample / Fermeture selon échantillon / Cierre según muestra

# DISKUS® 24 | 24RK

ORIGINAL ABUS DISKUS WITH EXCHANGEABLE CYLINDER



Service Kit

More Information



## TECHNOLOGY AND FEATURES

- Round shape plus narrow shackle opening makes it difficult to access with heavy-duty tools
- Shackle made from hardened alloy steel
- Ideally used with ABUS Diskus® Hasp 140: virtually impossible to attack shackle
- Additional protection against sawing
- Sophisticated welded seam for highest break resistance
- Precision pin tumbler cylinder
- Made in Germany
- 2 keys

## CARACTÉRISTIQUES TECHNIQUES

- La forme arrondie écarte les attaques faites avec des outils manuels
- Anse en acier cémenté
- Idéal en combinaison avec morillons ABUS Diskus® 140, empêchant l'accès à l'anse avec des outils d'effraction
- Protection supplémentaire contre les scies
- Soudure d'excellente qualité
- Cylindre qualité ABUS
- Made in Germany
- Deux clés incluses

## CARACTERÍSTICAS TÉCNICAS

- Su forma redonda añadida a la estrecha apertura del arco lo convierte en especialmente difícil de acceder a las más resistentes herramientas
- Arco fabricado en acero de aleación endurecido
- En conjunto con ABUS Diskus Raid 140 no hay acceso al soporte con herramientas de demolición
- Protección adicional contra serrado
- Costura de soldadura con la más alta calidad
- Cilindro de discos ABUS-Plus: la más alta protección contra la manipulación, el taladrado y la extracción
- Fabricado en Alemania
- 2 llaves

Ref. No. Référence Referencia	EAN 4003318							Weight g Poids g Peso g	Key Blank Ébauche Llave en bruto	Level Degré Nivel	Box Quantity Unité d'emballage Cantidad de cajas
		mm	mm	mm	mm	mm	mm				
24/70	01107 8	70	20	17	10	29	70	323	12874	8	6
24/70 Lock-Tag	81695 6	70	20	17	10	29	70	317	12874	8	6
24RK/70	12788 5	70	20	17	10	29	70	825	12874	8	6
Master Key	02745 1										1

## SURCHARGE / MAJORATION / RECARGO

- Keyed alike / S'entrouvrant / Llaves iguales
- Keyed alike as per sample / Fermeture selon échantillon / Cierre según muestra
- up to 49 pcs/jusqu'à 49 pces./hasta 49 pzas.
- as of 50 pcs/à partir de 50 pces./a partir de 50 pzas.
- Master key function / Clé passe / Funcion llave maestra

# DISKUS® 24IB | 24IBWY

ORIGINAL ABUS DISKUS - 100% STAINLESS STEEL SECURITY



Product Video



## TECHNOLOGY AND FEATURES

- Lock body, inner parts and shackle made solely from stainless steel for extreme resistance to corrosion
- Cylinder cover – maximum protection against dirt and water spray (60 mm and 70 mm only)
- Nickel-plated cylinder for enhanced weather protection
- Original Diskus® design: 360° protection
- Diskus® Deep-Welding Technology – the best in break-in protection
- Precision pin cylinder
- Key retaining: locking only with the key (key cannot be removed while the lock remains open)
- Made in Germany
- WY: comes with security card to protect against unauthorized key duplicates

## CARACTÉRISTIQUES TECHNIQUES

- Boîtier, intérieur et anse intégralement en acier inoxydable pour une protection anti-corrosion maximale
- Masquage des cylindres - protection maximale contre la saleté et les projections d'eau (uniquement pour 60 et 70 mm)
- Cylindre nickelé pour une protection optimale contre les intempéries
- Original Diskus® design : protection à 360°
- Technique de soudage Diskus® - Résistance maximale
- Cylindre à goupilles de précision
- Fermeture obligatoire : verrouillage uniquement avec la clé (la clé ne peut pas être retirée quand le cadenas est ouvert)
- Made in Germany
- WY: Une clé de rechange n'est délivrée que sur présentation de la carte de propriété

## CARACTERÍSTICAS TÉCNICAS

- Cuerpo, interior y arco fabricado en acero inoxidable para una resistencia a la corrosión extrema
- Tapa para cubrir el cilindro y protegerlo de la suciedad y la humedad (sólo a 60 y 70 mm)
- Cilindro niquelado para reforzar la resistencia a la corrosión
- Diseño original Diskus®: 360° de protección
- Tecnología de Soldadura Profunda Diskus® - robustez máxima
- Cilindro de pitones de precisión anti-ganzúa
- Llave retenida: Sólo se podrá cerrar con la llave (la llave se queda en el candado hasta que éste haya sido cerrado)
- Fabricado en Alemania
- WY: la versión con tarjeta de seguridad protege las copias de llaves indeseadas

Ref. No. Référence Referencia	EAN 4003318							Weight g Poids g Peso g	Key Blank Ébauche Llave en bruto	Level Degré Nivel	Box Quantity Unité d'emballage Cantidad de cajas
		mm	mm	mm	mm	mm	mm				
24IB/50	20317 6	51	13	8	6,5	25,5	50	113	02706	7	6
24IB/60	05584 3	60	17	13	8	26	60	220	02706	7	6
24IB/70	02050 6	70	20	17	10	31	70	320	12874	8	6
24IB/50 B/EFSP	35041 2	51	13	8	6,5	25,5	50	143	02706	7	6
24IB/60 B/EFSP	35043 6	60	17	13	8	26	60	220	02706	7	6
24IB/70 B/EFSP	35044 3	70	20	17	10	31	70	320	12874	8	6
24IB/70 Twins B/EFSP	47840 6	70	20	17	10	31	70	320	12874	8	2
24WYIB/70 with 4 keys	82330 5	70	20	17	10	31	70	313	82329	8	6
24IB/60 Lock-Tag	81693 2	60	17	13	8	26	60	313	02706	7	6
24IB/70 Lock-Tag	81694 9	70	20	17	10	31	70	313	12874	8	6
Master Key	02745 1										1

## SURCHARGE / MAJORATION / RECARGO

- Keyed alike / S'entrouvrant / Llaves iguales
- Keyed alike as per sample / Fermeture selon échantillon / Cierre según muestra
- up to 49 pcs/jusqu'à 49 pces./hasta 49 pzas.
- as of 50 pcs/à partir de 50 pces./a partir de 50 pzas.
- Master key function / Clé passe / Funcion llave maestra

# DISKUS® 28

ORIGINAL ABUS DISKUS - 360° PROTECTION



More Information



## TECHNOLOGY AND FEATURES

- Original Diskus® design: 360° protection
- Diskus® Deep-Welding Technology for maximum strength
- Shackle made of hardened steel
- Precision pin cylinder with anti-pick pins
- Made in Germany

## CARACTÉRISTIQUES TECHNIQUES

- L'ouverture étroite de l'anse et sa forme arrondie protègent contre des attaques brutales
- Technique de soudage Diskus® - Résistance maximale
- Anse en acier cémentée
- Cylindre de précision à goupilles, avec protection anticrochetage
- Fabriqué en Allemagne

## CARACTERÍSTICAS TÉCNICAS

- Diseño original Diskus®: protección en 360°
- Tecnología de Soldadura Profunda Diskus® - robustez máxima
- Arco de acero endurecido especial
- Cilindro de pitones de precisión
- Fabricado en Alemania

Ref. No. Référence Referencia	EAN 4003318							Weight g Poids g Peso g	Key Blank Ébauche Llave en bruto	Level Degré Nivel	Box Quantity Unité d'emballage Cantidad de cajas
		mm	mm	mm	mm	mm	mm				
28/60 B/EFSP	54857 4	60	17,5	13,5	7,5	26	60	177		7	6
28/60 vs.	54855 0	60	17,5	13,5	7,5	26	60	177		7	6
28/70 B/EFSP	50710 6	70	19,5	17,5	10	27	70	249		7	6
28/70 vs.	11514 1	70	19,5	17,5	10	27	70	249		7	6

## SURCHARGE / MAJORATION / RECARGO

- Keyed alike / S'entrouvrant / Llaves iguales
- Keyed alike as per sample / Fermeture selon échantillon / Cierre según muestra
- up to 49 pcs/jusqu'à 49 pces./hasta 49 pzas.
- as of 50 pcs/à partir de 50 pces./a partir de 50 pzas.
- Master key function / Clé passe / Funcion llave maestra



More Information



### TECHNOLOGY AND FEATURES

- Original Diskus® design: 360° protection
- Diskus® Deep-Welding Technology - maximum strength
- Hardened steel shackle
- Precision pin tumbler cylinder with anti-pick pins
- Key retaining: locking only with the key (lock retains key until locked)
- Made in Germany

### CARACTÉRISTIQUES TECHNIQUES

- Design original de Diskus® : protégé à 360°
- Technologie de soudage Diskus® - meilleure protection contre le rodage
- Anse en acier trempé
- Cylindre de précision à goupilles avec goupilles anti-crochetage
- Fermeture obligatoire : Verrouillage uniquement avec la clé (la clé ne peut pas être retirée dans l'état ouvert)
- Fabriqué en Allemagne

### CARACTERÍSTICAS TÉCNICAS

- Diseño original Diskus®: protección de 360°
- Tecnología de soldadura Diskus®: la mejor protección contra manipulaciones
- Arco de acero reforzado
- Cilindro de barra de precisión con pernos anti-picking
- Cierre obligatorio: bloqueo solo con la llave (la llave no se puede extraer con el candado abierto)
- Made in Germany

Ref. No. Référence Referencia	EAN 4003318	mm	mm	mm	mm	mm	mm	Weight g Poids g Peso g	Key Blank Ébauche Llave en bruto	Level Degré Nivel	Box Quantity Unité d'emballage Cantidad de cajas
220/70 vs.	820915	70	19,5	17	10	27	70	258	12874	7	6

### SURCHARGE / MAJORATION / RECARGO

- Keyed alike / S'entrouvrant / Llaves iguales
- Keyed alike as per sample / Fermeture selon échantillon / Cierre según muestra
- up to 49 pcs/jusqu'à 49 pces./hasta 49 pzas.
- as of 50 pcs/à partir de 50 pces./a partir de 50 pzas.

## LAMINATED ETERNA™ PLATED STEEL PADLOCK

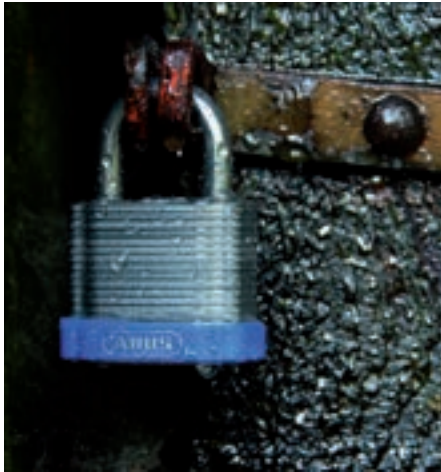

41/30HB50

41/40HB50

41/45HB50

41/50HB50

41/50HB125



### TECHNOLOGY AND FEATURES

- Laminated steel with ETERNA™ coating on each laminate for extreme corrosion resistance
- Laminates individually treated for top corrosion protection
- Rivets concentrated in the outer laminates to protect the rivet heads from being chipped off
- Hardened shackle, double bolted, as of 40 mm made from special alloy
- Precision pin tumbler cylinder
- Self-locking: Locking without key by pushing down the shackle
- Made in Germany

### CARACTÉRISTIQUES TECHNIQUES

- Lamelles en acier
- Galvanisées individuellement ETERNA2122 pour une haute protection anti-corrosion
- Solides rivets à tête encastrée
- Support durci, à double verrouillage, à partir de 40 mm en alliage spécial
- Cylindre de précision à goupilles
- Le cylindre avec protection anti-perçage et anti-arrachage
- Made in Germany

### CARACTERÍSTICAS TÉCNICAS

- Acero laminado, con recubrimiento ETERNA™ en cada lámina para una extrema protección contra la corrosión
- ETERNA™: Revestimiento exento de cadmio (un metal pesado tóxico)
- Remaches robustos embutidos
- Soporte endurecido, doble bloqueo, de 40 mm fabricado en aleación especial
- Cilindro de precisión de 5 pitones con protección anti-taladro y anti-palanca
- Bloqueo automático: bloqueo sin llave presionando hacia abajo el soporte
- Made in Germany

Ref. No. Référence Referencia	EAN 4003318							Weight g Poids g Peso g	Key Blank Ébauche Llave en bruto	Level Degré Nivel	Box Quantity Unité d'emballage Cantidad de cajas
		mm	mm	mm	mm	mm	mm				
41/30	06371 8	35	15	15	5	22	54	130	02706	5	12
41/40	06376 3	44	18	20	7	26	60	214	12874	6	12
41/45	06381 7	49	20	23	8	28	67	280	12874	6	6
41/50	06386 2	53	23	25	9	29	75	363	12874	7	6
41/30 B/EFSP	35827 2	35	15	15	5	22	54	167	02706	5	6
41/40 B/EFSP	35066 5	44	18	20	7	26	60	214	12874	6	6
41/45 B/EFSP	35068 9	49	20	23	8	28	67	280	12874	6	6
41/50 B/EFSP	35069 6	53	23	25	9	29	75	363	12874	7	6
41/30HB50	01225 9	35	15	50	5	22	83	133	02706	5	12
41/40HB50	06391 6	44	18	50	7	26	87	230	12874	6	6
41/45HB50	01237 2	49	20	50	8	28	94	309	12874	6	6
41/50HB50	01243 3	53	23	50	9	29	100	402	12874	7	6
41/50HB125	01248 8	53	23	125	9	29	174	450	12874	7	6

### SURCHARGE / MAJORATION / RECARGO

- Keyed alike / S'entrouvrant / Llaves iguales
- Master key function / Clé passe / Función llave maestra

# TITALIUM™ PADLOCKS

STRONG | LIGHTWEIGHT | INNOVATIVE

TITALIUM™ lock body is very light, but as strong as traditional brass padlocks

Shackle with NANO PROTECT™ Plating for extra corrosion resistance



World innovation, special aluminum alloy developed by ABUS

With approximately 30% reduced weight compared to traditional brass padlocks with at least the same level of security, the TITALIUM™ lock series represents a revolution in the padlock market.

The TITALIUM™ material is a special aluminum alloy that, just like in the aircraft industry, combines two fundamental qualities: maximum strength and low weight.

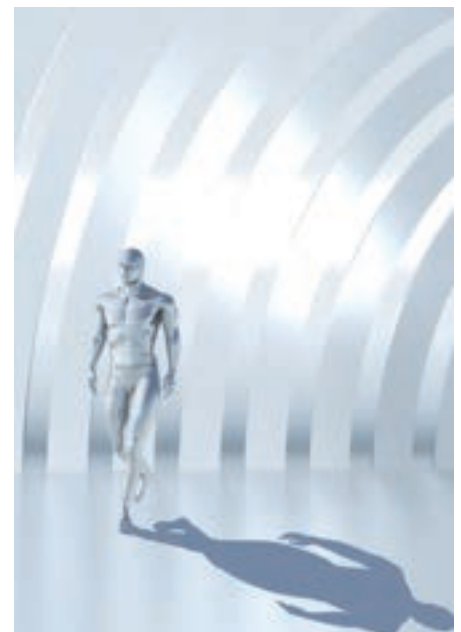

# 98 TITALIUM™

## MONOBLOC PADLOCK WITH REVERSIBLE KEY SYSTEM



### TECHNOLOGY AND FEATURES

- Lock body made from TITALIUM™ special aluminium – high security with low weight
- 12 mm special hardened steel shackle
- High precision reversible keyway with 150,000 key differs
- Automatic locking: Locking without key by pushing the shackle
- Paracentric keyway for increased protection against manipulation

### CARACTÉRISTIQUES TECHNIQUES

- Boîtier massif en aluminium spécial TITALIUM™ - poids léger, sûreté élevée
- Anse en acier spécial cémenté
- Confection de clé réversible ultra - précise avec 150.000 fermetures différentes
- Verrouillage automatique
- Profil de clé paracentrique pour une protection élevée contre les effractions

### CARACTERÍSTICAS TÉCNICAS

- Cuerpo macizo de aleación de Aluminio TITALIUM™ alta seguridad y ligereza
- Arco de acero endurecido
- Un medio cilindro europeo puede ser alojado facilmente, sin necesidad de herramientas especiales
- Cierre automático
- Perfil paracentrico par evitar la manipulacion

Ref. No. Référence Referencia	EAN 4003318							Weight g Poids g Peso g	Key Blank Ébauche Llave en bruto	Level Degré Nivel	Box Quantity Unité d'emballage Cantidad de cajas
		mm	mm	mm	mm	mm	mm				
98TI/70	70746 9	70	22	14	12	23	50	196	26424	7	6
98TI/90	70747 6	90	35	18	12	28	60	346	26424	8	3
98TI/70 B/EFSP	70985 2	70	22	14	12	23	50	196	26424	7	6
98TI/90 B/EFSP	70987 6	90	35	18	12	28	60	346	26424	8	3

### SURCHARGE / MAJORATION / RECARGO

- Keyed alike / S'entrouvrant / Llaves iguales



# 82 TITALIUM™

## MONOBLOC PADLOCK



### TECHNOLOGY AND FEATURES







- Solid lock body made from TITALIUM™ special aluminium – high security with low weight
- 12 mm hardened special steel shackle
- A hardened steel pin protects the narrow side of the lock body against sawing
- Precision pin tumbler cylinder with a high number of key differs
- Automatic locking: Locking without key by pushing the shackle

### CARACTÉRISTIQUES TECHNIQUES

- Boîtier massif en aluminium spécial TITALIUM™ - poids léger, sûreté élevée
- Pêne de verrouillage en acier cémenté, diamètre: 12 mm
- Protection anti-sciage de la partie étroite du boîtier grâce à un piston en acier cémenté
- Mécanisme de fermeture à goupilles de haute précision avec un très grand nombre de clés différentes
- Verrouillage automatique

### CARACTERÍSTICAS TÉCNICAS

- Cuerpo del candado de aleación especial de aluminio TITALIUM™
- 12 mm Arco de acero endurecido especial
- Un pitón de acero endurecido protege el lado estrecho del cuerpo contra corte con sierra
- Cilindro de pitones de precisión y gran cantidad de combinaciones distintas posibles
- Cierre automático: Cierre sin llave presionando el arco

Ref. No. Référence Referencia	EAN 4003318	 mm	 mm	 mm	 mm	 mm	 mm	Weight g Poids g Peso g	Key Blank Ébauche Llave en bruto	Level Degré Nivel	Box Quantity Unité d'emballage Cantidad de cajas
82TI/70	24673 9	70	22	13	12	20	50	194	00906	6	6
82TI/70 B/EFSP	24670 8	70	22	13	12	20	50	194	00906	6	3

### SURCHARGE / MAJORATION / RECARGO

- Keyed alike / S'entrouvrant / Llaves iguales

# 96 TITALIUM™

THE ABSOLUTE IN TECHNICAL STRENGTH WITH REVERSIBLE KEY



## TECHNOLOGY AND FEATURES

- Lock body made of TITALIUM™ special aluminium - high security with low weight
- Hardened steel shackle with NANO PROTECT™ plating for extreme corrosion resistance
- High precision reversible keyway with 150 000 key differs
- Automatic locking: Locking without key by pushing the shackle
- Paracentric keyway for increased protection against manipulation
- CS: shackle guard protects shackle from attack

## CARACTÉRISTIQUES TECHNIQUES

- Boîtier massif en aluminium spécial TITALIUM™ - poids léger, sûreté élevée
- Anse en acier spécial cémenté avec technologie NANO PROTECT™
- Confection de clé réversible ultra-précise avec 150 000 fermetures différentes
- Verrouillage automatique
- Profil de clé paracentrique pour une protection élevée contre les effractions
- CS : anse blindée : pratiquement inaccessible aux outils d'attaques conventionnels

## CARACTERÍSTICAS TÉCNICAS

- Cuerpo macizo de aleación de Aluminio TITALIUM- alta seguridad y ligereza
- Arco de acero endurecido con revestimiento NANO PROTECT™
- Mecanismo de bloqueo de llave reversible de alta precisión con 150.000 cerraduras diferentes
- Cierre automático
- Perfil paracentrico par evitar la manipulacion
- CS: la protección de planchado dificulta el acceso a herramientas de ruptura

Ref. No. Référence Referencia	EAN 4003318							Weight g Poids g Peso g	Key Blank Ébauche Llave en bruto	Level Degré Nivel	Box Quantity Unité d'emballage Cantidad de cajas
		mm	mm	mm	mm	mm	mm				
96TI/50	70872 5	50	25	34	9,5	23	92	212	26424	8	6
96TI/60	70879 4	60	25	40	11	28	103	332	26424	8	6
96TI/50 B/EFSP	70979 1	50	25	34	9,5	23	92	295	26424	8	6
96TI/60 B/EFSP	70982 1	60	25	40	11	28	103	418	26424	8	6
96CSTI/50	70263 1	50	23	25	9,5	23	82	214	26424	8	6
96CSTI/60	70262 4	60	25	29	11	28	91	350	26424	8	6
96CSTI/50 B/EFSP	70266 2	50	23	25	9,5	23	82	298	26424	8	4
96CSTI/60 B/EFSP	70267 9	60	25	29	11	28	91	438	26424	8	4

## SURCHARGE / MAJORATION / RECARGO

- Keyed alike / S'entrouvrant / Llaves iguales

# 80 TITALIUM™

THE ABSOLUTE IN TECHNICAL STRENGTH



## TECHNOLOGY AND FEATURES

- Solid lock body made from TITALIUM™ aluminium alloy - higher security, less weight
- Hardened steel shackle with NANO PROTECT™ plating for extreme corrosion resistance
- 6-pin precision cylinder with paracentric keyway
- Double bolted shackle
- Chrome-plated cylinder plugs with additional corrosion resistance
- Large tulip-shaped key head

## CARACTÉRISTIQUES TECHNIQUES

- Boîtier massif en aluminium spécial TITALIUM™ - poids léger, sûreté élevée
- Anse en acier spécial cémenté avec technologie NANO PROTECT™
- Cylindre de précision à 6 goupilles à profil de sécurité paracentrique
- Double verrouillage de l'anse
- Rotors des cylindres chromés pour une bonne protection supplémentaire contre la corrosion
- Grande tête de clé en forme de tulipe

## CARACTERÍSTICAS TÉCNICAS

- Gran cuerpo del candado de aleación especial de aluminio TITALIUM™ alta seguridad con peso ligero
- Arco de acero endurecido especial con recubrimiento de NANO PROTECT™
- Cilindro de precisión de 6 pitones con perfil de la llave paracentrico
- Doble enganche
- Rotor de cilindro cromado
- Llave ABUS con forma de tulipa

Ref. No. Référence Referencia	EAN 4003318							Weight g Poids g Peso g	Key Blank Ébauche Llave en bruto	Level Degré Nivel	Box Quantity Unité d'emballage Cantidad de cajas
		mm	mm	mm	mm	mm	mm				
80TI/40	56220 4	40	20,5	25,5	7	19	74,5	125	57862	6	12
80TI/45	56230 3	45	25	29	8	21	82	183	57862	7	6
80TI/50	56234 1	50	25	35	10	23	93	243	57862	8	6
80TI/60	26944 8	60	25,5	40	11	28	103	243	57862	8	6
80TI/40 B/EFSP	56553 3	40	20	25	7	19	75	152	57862	6	6
80TI/45 B/EFSP	56573 1	45	20	29	8	21	82	183	57862	7	6
80TI/50 B/EFSP	56574 8	50	25	35	9,5	23	93	243	57862	8	6
80TI/60 B/EFSP	26947 9	60	25,5	40	11	28	103	243	57862	8	4
80TI/40HB40	56224 2	40	20,5	40	7	19	89	159	57862	6	3
80TI/40HB63	56227 3	40	20,5	63	7	19	112	175	57862	6	3
80TI/40HB40 B/EFSP	56571 7	40	20	40	7	19	88	159	57862	6	6
80TI/40HB63 B/EFSP	56572 4	40	20	63	7	19	113	175	57862	6	6
80TI/40 vs. Lock-Tag	80288 1	40	20	25	7	19	75	162	57862	6	12
80TI/45 vs. Lock-Tag	80289 8	45	25	29	8	21	82	196	57862	7	6
80TI/50 vs. Lock-Tag	80290 4	50	25	35	9,5	23	93	260	57862	8	6
80TI/60 vs. Lock-Tag	80291 1	60	25,5	40	11	28	103	382	57862	8	6

## SURCHARGE / MAJORATION / RECARGO

- Keyed alike / S'entrouvrant / Llaves iguales

# 64 TITALIUM™

LIGHT AND YET ROBUST



## TECHNOLOGY AND FEATURES

- Solid lock body made from TITALIUM™ special aluminium
- Hardened steel shackle with NANO PROTECT™ coating for extreme corrosion resistance
- 64TI/50HB60-150: Removable and adjustable shackle from 60 mm to 150 mm
- Paracentric key profile for increased protection against manipulation
- Double bolted shackle
- Chrome-plated cylinder plug for additional corrosion protection
- Tulip-shaped key head







## CARACTÉRISTIQUES TECHNIQUES

- Corps de chaînes massif en aluminium spécial TITALIUM™
- Anse en acier spécial cémenté avec revêtement NANO PROTECT™ pour une meilleure résistance à la corrosion
- 64TI/50HB60-150: Anse amovible et de taille réglable entre 60 et 150 mm
- Profil de clé paracéntrique pour une protection élevée contre les effractions
- Double verrouillage de l'anse
- Cœur du cylindre chromé pour une protection accrue contre la corrosion
- Tête de clé en forme de tulipe

## CARACTERÍSTICAS TÉCNICAS

- Cuerpo del candado de aluminio especial TITALIUM™ macizo
- Arco de acero endurecido con revestimiento NANO-PROTECT™ para una alta protección contra la corrosión
- 64TI/50HB60-150: Arco extraíble y ajustable en tamaño de 60 mm a 150 mm
- Perfil de llave paracéntrico para una mayor protección antimanipulación
- Bloqueo doble de arco
- Núcleo del cilindro cromado para una protección anticorrosión adicional
- Cabezal de la llave con forma de tulipán

Ref. No. Référence Referencia	EAN 4003318							Weight g Poids g Peso g	Key Blank Ébauche Llave en bruto	Level Degré Nivel	Box Quantity Unité d'emballage Cantidad de cajas
		mm	mm	mm	mm	mm	mm				
64TI/20	55878 8	20	9,5	11,5	3,5	10	34,5	21	11405	3	12
64TI/25	56182 5	25	13	13,5	4	12	41,5	31	11406	3	12
64TI/30	56186 3	30	16	17	5	13	49,5	53	12021	4	12
64TI/35	56194 8	35	18,5	20	5,5	14	55	67	12021	4	12
64TI/40	54573 3	40	22	23	6,5	14,5	62	87	12022	5	12
64TI/45	56198 6	45	25,5	24	7	15	68	109	12022	5	6
64TI/50	56203 7	50	29	29	8	17	77	159	12023	6	6
64TI/60	56352 2	60	33,5	34	9,5	19	90,5	236	12023	6	6
64TI/20 B/EFSP	56361 4	20	9,5	11,5	3,5	10	34,5	21	11405	3	6
64TI/25 B/EFSP	56362 1	25	13	13,5	4	12	41,5	31	11406	3	6
64TI/30 B/EFSP	56363 8	30	16	17	5	13	49,5	53	12021	4	12
64TI/35 B/EFSP	56364 5	35	18,5	20	5,5	14	55	67	12021	4	6
64TI/40 B/EFSP	55015 7	40	22	23	6,5	14,5	62	87	12022	5	6
64TI/45 B/EFSP	56365 2	45	25,5	24	7	15	68	109	12022	5	6
64TI/50 B/EFSP	56366 9	50	29	29	8	17	77	159	12023	6	6
64TI/60 B/EFSP	56383 6	60	33,5	34	9,5	19	90,5	236	12023	6	4
64TI/30HB60	56191 7	30	16	60	5	13	93	65	12021	4	3
64TI/40HB40	54589 4	40	22	40	6	15	79	96	12022	5	3
64TI/40HB63	54590 0	40	22	63	6	15	102	107	12022	5	3
64TI/50HB80	56208 2	50	28	80	8	17	128	199	12023	6	3
64TI/30HB60 B/EFSP	56374 4	30	16	60	5	13	93	65	12021	4	6

Ref. No. Référence Referencia	EAN 4003318							Weight g Poids g Peso g	Key Blank Ébauche Llave en bruto	Level Degré Nivel	Box Quantity Unité d'emballage Cantidad de cajas
		mm	mm	mm	mm	mm	mm				
64TI/40HB40 B/EFSP	55021 8	40	22	40	6,5	14,5	78	96	12022	5	3
64TI/40HB63 B/EFSP	56377 5	40	22	63	6,5	14,5	101	107	12022	5	3
64TI/50HB80 B/EFSP	56382 9	50	29	80	8	17	128,5	199	12023	6	6
64TI/20 Twins B/EFSP	56373 7	20	9,5	11,5	3,5	10	34,5	21	11405	3	6
64TI/30 Twins B/EFSP	56375 1	30	16	17	5	13	49,5	53	12021	4	6
64TI/40 Twins B/EFSP	56378 2	40	22	23	6,5	14,5	62	87	12022	5	6
64TI/40 Triples B/EFSP	56379 9	40	22	23	6,5	14,5	62	87	12022	5	4
64TI/40 Quads B/EFSP	56381 2	40	22	23	6,5	14,5	62	87	12022	5	4
64TI/40 + HB63 Triples B/EFSP	56380 5	40	22	63	6,5	14,5	101	107	12022	5	4
64TI/20 vs. Lock-Tag	79458 2	20	9,5	11,5	3,5	10	34,5	23	12022	3	12
64TI/25 vs. Lock-Tag	79468 1	25	13	13,5	4	12	41,5	36	12022		12
64TI/30 vs. Lock-Tag	77581 9	30	16	17	5	13	49,5	54	12022		12
64TI/35 vs. Lock-Tag	79473 5	35	18,5	20	5,5	14	55	71	12022		12
64TI/40 vs. Lock-Tag	79474 2	40	22	23	6,5	14,5	62	92	12022		12
64TI/45 vs. Lock-Tag	79477 3	45	25,5	24	7	15	68	115	12022		6
64TI/50 vs. Lock-Tag	77086 9	50	29	29	8	17	77	167	12022		6
64TI/60 vs. Lock-Tag	79480 3	60	33,5	34	9,5	19	90,5	252	12022		6
64TI/30HB60 vs. Lock-Tag	79469 8	30	16	60	5	13	93	77	12022		3
64TI/40HB40 vs. Lock-Tag	79475 9	40	22	40	6,5	14,5	78	103	12022		3
64TI/40HB63 vs. Lock-Tag	79476 6	40	22	63	6,5	14,5	101	115	12022		3
64TI/50HB80 vs. Lock-Tag	79479 7	50	28	80	8	17	128	216	12022		3

**SURCHARGE / MAJORATION / RECARGO**

• Keyed alike / S'entrouvrant / Llaves iguales

## FLEXIBLE SHACKLE



### TECHNOLOGY AND FEATURES







- Solid lock body made from TITALIUM™ special aluminium
- Hardened steel shackle with NANO PROTECT™ coating for extreme corrosion resistance
- 64TI/50HB60-150: Removable and adjustable shackle from 60 mm to 150 mm
- Paracentric key profile for increased protection against manipulation
- Double bolted shackle
- Chrome-plated cylinder plug for additional corrosion protection
- Tulip-shaped key head

### CARACTÉRISTIQUES TECHNIQUES

- Corps de cadenas massif en aluminium spécial TITALIUM™
- Anse en acier spécial cémenté avec revêtement NANO PROTECT™ pour une meilleure résistance à la corrosion
- 64TI/50HB60-150: Anse amovible et de taille réglable entre 60 et 150 mm
- Profil de clé paracentrique pour une protection élevée contre les effractions
- Double verrouillage de l'anse
- Cœur du cylindre chromé pour une protection accrue contre la corrosion
- Tête de clé en forme de tulipe

### CARACTERÍSTICAS TÉCNICAS

- Cuerpo del candado de aluminio especial TITALIUM™ macizo
- Arco de acero endurecido con revestimiento NANO-PROTECT™ para una alta protección contra la corrosión
- 64TI/50HB60-150: Arco extraíble y ajustable en tamaño de 60 mm a 150 mm
- Perfil de llave paracéntrico para una mayor protección antimanipulación
- Bloqueo doble de arco
- Núcleo del cilindro cromado para una protección anticorrosión adicional
- Cabezal de la llave con forma de tulipán

Ref. No. Référence Referencia	EAN 4003318	 mm	 mm	 mm	 mm	 mm	 mm	Weight g Poids g Peso g	Key Blank Ébauche Llave en bruto	Level Degré Nivel	Box Quantity Unité d'emballage Cantidad de cajas
64TI/50HB60-150 B/EFSP	88884 7	50	28	60-150	8	17	77		12022	6	
64TI/50HB60-150 keyed alike	63308 9	50	28	60-150	8	17	77		12022	6	

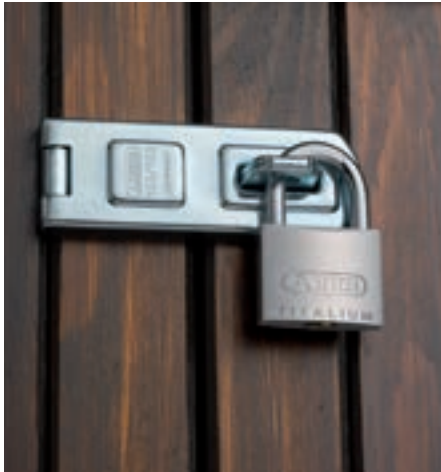

### TECHNOLOGY AND FEATURES

- Solid lock body made from TITALIUM™ aluminium alloy - higher security, less weight
- Hardened steel shackle
- Double bolted

### CARACTÉRISTIQUES TECHNIQUES

- Boîtier massif en aluminium spécial TITALIUM™ - poids léger, sûreté élevée
- Anse en acier cémenté
- Double verrouillage de l'anse

### CARACTERÍSTICAS TÉCNICAS

- Cuerpo del candado de aleación especial TITALIUM™, alta seguridad con peso ligero
- Arco de acero endurecido
- Cierre de doble enganche

Ref. No. Référence Referencia	EAN 4003318							Weight g Poids g Peso g	Key Blank Ébauche Llave en bruto	Level Degré Nivel	Box Quantity Unité d'emballage Cantidad de cajas
		mm	mm	mm	mm	mm	mm				
54TI/30	56213 6	29	14,5	14,5	5	13	45	47	02880	3	12
54TI/35	56214 3	33	18	17	5	13	48	52	02880	3	12
54TI/40	56215 0	38	20,5	21	6,5	13	57	70	02882	4	12
54TI/50	56217 4	48	25,5	25	7	14	68,5	93	02884	5	6
54TI/30 B/EFSP	56441 3	29	14,5	14,5	5	13	45	77	02880	3	6
54TI/35 B/EFSP	56442 0	33	18	17	5	13	48	81	02880	3	6
54TI/40 B/EFSP	56443 7	38	20,5	21	6,5	13	57	107	02882	4	6
54TI/40HB63 B/EFSP	56444 4	38	20,5	63,5	6,5	13	100	126	02882	4	6
54TI/50 B/EFSP	56447 5	48	25,5	25	7	14	68,5	143	02884	5	6
54TI/40HB63	56216 7	38	20,5	63,5	6,5	13	100	92	02882	4	3
54TI/30 Lock-Tag	80602 5	29	14,5	14,5	5	13	45	47	02880	3	12
54TI/35 Lock-Tag	80605 6	33	18	17	5	13	48	52	02880	3	12
54TI/40 Lock-Tag	80606 3	38	20,5	21	6,5	13	57	73	02882	4	12
54TI/50 Lock-Tag	80608 7	48	25,5	25	7	14	68,5	112	02884	5	6
54TI/40HB63 Lock-Tag	80607 0	38	20,5	63,5	6,5	13	100	98	02882	4	3
54TI/40 Twins B/EFSP	56445 1	38	20,5	21	6,5	13	57	173	02882	4	6
54TI/40 Triples B/EFSP	56446 8	38	20,5	21	6,5	13	57	237	02882	4	4

# 86 TITALIUM™

## TITALIUM™ PADLOCK WHICH ACCOMMODATES DOOR HALF CYLINDERS



86TI/45HB80

86TIIB/45HB80



### TECHNOLOGY AND FEATURES







- Solid lock body made from TITALIUM™ aluminium alloy - high security with low weight
- Hardened steel shackle with NANO PROTECT™ plating for extreme corrosion resistance
- Customary EURO-cylinders can be integrated easily without special tools
- Double bolted shackle
- Possible to integrate into keying systems
- 86TI/55: Key retaining or automatic locking (depending on position of cam)
- 25°: Automatic locking (only for adjustable strike plates)
- 45°: Key-retaining
- 86TI/45: Key retaining

### CARACTÉRISTIQUES TECHNIQUES

- Corps robuste en aluminium spécial TITALIUM™ - un maximum de sécurité avec un minimum de poids
- Anse en acier spécial cémenté avec technologie NANO PROTECT™
- Conçu pour demi-cylindres standard, disponible dans le commerce spécialisé, montage facile, sans outillage spécial
- Double verrouillage à bille
- Possibilité de l'intégrer dans des systèmes d'organigramme
- 86TI/55 : Fermeture obligatoire ou verrouillage automatique (selon la position du panneton)
- Verrouillage automatique si panneton à 25°
- Fermeture obligatoire si panneton à 45°
- 86TI/45 : Fermeture obligatoire

### CARACTERÍSTICAS TÉCNICAS

- Cuerpo macizo de aleación de Aluminio TITALIUM™ alta seguridad y ligereza
- Arco de acero endurecido con revestimiento NANO PROTECT™
- Un medio cilindro europeo puede ser alojado fácilmente, sin necesidad de herramientas especiales
- Candado de doble enganche
- Posibilidad de integrarlo en amaestramientos
- 86TI/55: Llave retenida o auto-cierre
- Bloqueo automático con la leva de cierre a 25°
- Cierre obligatorio con la leva de cierre a 45°
- 86TI/45: Llave retenida

Ref. No. Référence Referencia	EAN 4003318							Weight g Poids g Peso g	Key Blank Ébauche Llave en bruto	Level Degré Nivel	Box Quantity Unité d'emballage Cantidad de cajas
		mm	mm	mm	mm	mm	mm				
86TI/45 without cylinder	27778 8	45	26,5	32,5	8	27	96,5	213		7	3
86TI/55 without cylinder	58500 5	55	26,5	39,5	9,5	27,5	106,5	250		8	3
86TI/45HB80 without cylinder	04391 8	47	26	80	8	27	145	221		7	3
86TIIB/45 without cylinder	27779 5	45	26,5	32,5	8	27	96,5	185		8	3
86TIIB/45HB80 without cylinder	04392 5	47	26	80	8	27	145	221		7	3



# SILVER ROCK™ 5

SOLID & TOUGH



5/40HB40

5/40HB63

5/50HB80



## TECHNOLOGY AND FEATURES

- Heavy zinc body
- Hardened steel shackle with NANO PROTECT™ coating for increased protection against rust on shackle
- An innovative silicone protective bumper prevents scratches and damage
- The precision cylinder with paracentric key cuts protects against tampering
- Four standard sizes

## CARACTÉRISTIQUES TECHNIQUES

- Corps de chaînes en zinc lourd au visuel acier inoxydable brossé « Solid Body »
- Une manille en acier renforcé avec revêtement NANO PROTECT™ qui assure une protection très efficace contre la rouille
- Un corps de protection en silicone nouvelle génération prévient les rayures et les dommages
- Le cylindre de précision avec clé paracentrique assure une protection contre les tentatives d'effraction
- Quatre formats courants

## CARACTERÍSTICAS TÉCNICAS

- Cuerpo pesado de cinc
- Arco de acero templado con revestimiento NANO-PROTECT™ para una alta protección anticorrosión del arco
- Innovador marco protector de silicona
- Cilindro de perno 5 con perfil de llave paracéntrico
- 4 tamaños comunes

Ref. No. Référence Referencia	EAN 4003318							Weight g Poids g Peso g	Key Blank Ébauche Llave en bruto	Level Degré Nivel	Box Quantity Unité d'emballage Cantidad de cajas
		mm	mm	mm	mm	mm	mm				
5/40	77561 1	42,4	22	25	6,5	22,5	65	187	12022 0	5	12
5/45	77562 8	47	25	32,5	7	23	80	266	12023 7	6	6
5/50	77563 5	52,2	28	37,5	8	25	90	353	12023 7	7	6
5/55	77564 2	57,1	30,5	37	8,5	25	90	459	12023 7	7	6
5/40 B/EFSP	79266 3	42,4	22	25	6,5	22,5	65	213	12022 0	5	6
5/45 B/EFSP	79267 0	47	25	32,5	7	23	80	290	12023 7	6	6
5/50 B/EFSP	79268 7	52,2	28	37,5	8	25	90	383	12023 7	7	6
5/55 B/EFSP	79269 4	57,1	30,5	37	8,5	25	90	497	12023 7	7	6
5/40HB40	80879 1	42,4	22	40	6,5	20	79,8	187	12022 0	5	12
5/40HB63	80881 4	42,4	22	63	6,5	20	103	208	12022 0	5	12
5/50HB80	80883 8	52,2	28	80	8	23	132	391	12023 7	7	3
5/40HB40 B/EFSP	80885 2	42,4	22	40	6,5	20	79,8	221	12022 0	5	6
5/40HB63 B/EFSP	80886 9	42,4	22	63	6,5	20	103	232	12022 0	5	6
5/50HB80 B/EFSP	80887 6	52,2	28	80	8	23	132	427	12023 7	7	3
5/40 Twins B/EFSP	80888 3	42,4	22	25	6,5	22,5	65	402	12022 0	5	4
5/50 Twins B/EFSP	80889 0	52,2	28	37,5	8	25	90	766	12023 7	7	3

## SURCHARGE / MAJORATION / RECARGO

- Keyed alike / S'entrouvrant / Llaves iguales

# 92 MONOBLOC

## MONOBLOC PADLOCK WITH STEEL JACKET



### TECHNOLOGY AND FEATURES







- Solid lock body made from brass with steel jacket
- special hardened steel shackle
- Drill and pull resistance
- Precision pin cylinder
- Incl. two keys

### CARACTÉRISTIQUES TECHNIQUES

- Boîtier en laiton massif avec gaine en acier
- Anse en acier trempé spécial
- Protection contre le perçage et l'arrachement
- Cylindre à goupilles de précision
- 2 clés incluses

### CARACTERÍSTICAS TÉCNICAS

- Cuerpo de latón macizo con carcasa de acero
- El arco está fabricado en acero especial endurecido
- Resistente a la extracción y el taladro
- Cilindro de pitones de precisión
- Incluye 2 llaves

Ref. No. Référence Referencia	EAN 4003318	 mm	 mm	 mm	 mm	 mm	 mm	Weight g Poids g Peso g	Key Blank Ébauche Llave en bruto	Level Degré Nivel	Box Quantity Unité d'emballage Cantidad de cajas
92/65	30609 9	66,5	33	14	10	28	58	564	00906	7	3
92/80	20072 4	78	37	17	12	29,5	65	797	02703	8	3
92/65 B/EFSP	31938 9	66,5	33	14	10	28	58	564	00906	7	3
92/80 B/EFSP	35214 0	78	37	17	12	29,5	65	797	02703	8	3

### SURCHARGE / MAJORATION / RECARGO

- Keyed alike / S'entrouvrant / Llaves iguales

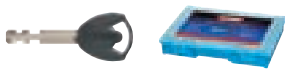

Service Kit

DIN EN	DIN EN		
12320	12320		
Kl. 3	Kl. 2	Kl. 2	Kl. 1
88/50	88/40	88/50	88/40



**TECHNOLOGY AND FEATURES**

- Lock body made from solid brass
- Chromed plated lock body for a better corrosion resistance
- Double bolted
- Shackle made from hardened alloy steel
- ABUS-Plus disc cylinder: highest protection against manipulation
- Cylinder can be re-keyed to match an existing key
- Key retaining: locking only with the key (lock retains key until locked)

**CARACTÉRISTIQUES TECHNIQUES**

- Boîtier en laiton massif
- Corps de cadenas chromé pour une meilleure protection contre la corrosion
- Double verrouillage à bille
- Anse en acier spécial, cémenté
- Cylindre ABUS-Plus à disques: très grand nombre de clés différentes. Très haute protection contre toutes sortes de manipulations
- Le cylindre peut-être modifié et adapté aux fermetures existantes
- Fermeture obligatoire : verrouillage uniquement avec la clé (la clé ne peut pas être retirée quand le cadenas est ouvert)

**CARACTERÍSTICAS TÉCNICAS**

- Cuerpo de latón macizo
- Arco de acero de aleación endurecido
- Cilindro de discos ABUS-Plus: máxima protección contra manipulaciones no autorizadas, gran cantidad de combinaciones de llaves diferentes
- Se puede amaestrar según llave de muestra

Ref. No. Référence Referencia	EAN 4003318							Weight g Poids g Peso g	Key Blank Ébauche Llave en bruto	Level Degré Nivel	Box Quantity Unité d'emballage Cantidad de cajas
		mm	mm	mm	mm	mm	mm				
88/40	07238 3	40	22	22,5	7	20	71,5	208	05078	8	6
88/50	07239 0	49,5	24	26	9,5	20,5	78,5	295	05078	7	6
88/40 B/EFSP	35208 9	40	22	22,5	7	20	71,5	208	05078	8	6
88/50 B/EFSP	35210 2	49,5	24	26	9,5	20,5	78,5	295	05078	7	6

**SURCHARGE / MAJORATION / RECARGO**

- Keyed alike / S'entrouvrant / Llaves iguales
- Keyed alike as per sample / Fermeture selon échantillon / Cierre según muestra
- up to 49 pcs/jusqu'à 49 pces./hasta 49 pzas.
- as of 50 pcs/à partir de 50 pces./a partir de 50 pzas.

# PREMIUM 289

## SOLID BRASS PADLOCK



289/40



289/45



289/50



### TECHNOLOGY AND FEATURES

- Lock body made from solid brass, high durability
- Hardened steel shackle with NANO PROTECT™ plating for extreme corrosion and sawing resistance
- Double bolted: excellent pulling resistance
- Disc cylinder: highest protection against manipulation, key retaining
- 3 keys included

### CARACTÉRISTIQUES TECHNIQUES

- Boîtier en laiton massif, haute durabilité
- Anse en acier cémenté avec revêtement NANO PROTECT™ pour une protection très élevée contre la corrosion et la sciage
- Double verrouillage (à billes) : excellente résistance à la traction
- Cylindre à disques : très haute protection contre toutes sortes de manipulations, fermeture obligatoire
- 3 clés incluses

### CARACTERÍSTICAS TÉCNICAS

- Cuerpo de latón macizo, alta durabilidad
- Arco fabricado en acero endurecido con recubrimiento NANO PROTECT™ para una resistencia extrema a la corrosión y al aserrado
- Doble enganche: excelente resistencia a la tracción
- Cilindro de discos: máxima protección contra manipulación, cierre obligatorio
- Incluye 3 llaves

Ref. No. Référence Referencia	EAN 4003318							Weight g Poids g Peso g	Key Blank Ébauche Llave en bruto	Level Degré Nivel	Box Quantity Unité d'emballage Cantidad de cajas
		mm	mm	mm	mm	mm	mm				
289/40 B/ETH w. 3 keys	88941 7	38,0	19,0	25,0	7,0	18,2	66,0	197	40485	5	6
289/45 B/ETH w. 3 keys	88942 4	45,0	23,5	28,5	8,0	19,0	75,5	266	40485	6	6
289/50 B/ETH w. 3 keys	88943 1	48,0	23,5	34,5	9,5	19,0	87,0	320	40485	7	6

### SURCHARGE / MAJORATION / RECARGO

- Keyed alike / S'entrouvrant / Llaves iguales



Product Video



**TECHNOLOGY AND FEATURES**

- Solid lock body made from brass
- 12 mm hardened special steel shackle
- A hardened steel pin protects the narrow side of the lock body against sawing
- Automatic locking: Locking without key by pushing down the shackle
- Precision pin cylinder
- Inner components made from rust-free materials
- Incl. two keys

**CARACTÉRISTIQUES TECHNIQUES**

- Cadenas en laiton massif
- Anse en acier trempé spécial
- Protection anti-sciage de la partie étroite du boîtier par un piston en acier cémenté
- Verrouillage automatique : Verrouillage sans clé par enfoncement de l'anse
- Cylindre de précision à goupilles
- Pièces intérieures en matériaux inoxydables
- 2 clés incluses

**CARACTERÍSTICAS TÉCNICAS**

- Cuerpo del candado de latón macizo
- Arco de acero endurecido
- Un pitón de acero endurecido protege el lado estrecho del cuerpo contra corte con sierra
- Auto-cierre: Cierre del candado mediante presión del arco
- Cilindro de pitones de precisión
- Componentes interiores fabricados con materiales inoxidables
- Incluye 2 llaves

Ref. No. Référence Referencia	EAN 4003318							Weight g Poids g Peso g	Key Blank Ébauche Llave en bruto	Level Degré Nivel	Box Quantity Unité d'emballage Cantidad de cajas
		mm	mm	mm	mm	mm	mm				
82/63	11490 8	64	19	14	10	18,5	45	303	00906	6	6
82/70	11491 5	70	22	13,5	12	20	51	438	00906	6	6
82/90	11492 2	90	35	17	12	20	60	725	02703	7	6
82/63 B/EFSP	33695 9	63	19	14	10	17	45	332	00906	6	3
82/70 B/EFSP	35327 7	70	22	13	12	18	50	438	00906	6	3
82/90 B/EFSP	32442 0	90	35	17	12	20	60	725	02703	7	3
82/70 KR vs.	96184 7	70	22	13,5	12	20	51	438	00906	6	6
82/90 KR vs.	96186 1	90	35	17	12	20	60	725	02703	7	6

**SURCHARGE / MAJORATION / RECARGO**

- Keyed alike / S'entrouvrant / Llaves iguales

# 85 + 85WY

## THE SERVICE LOCK



85WY Security Card

85WY/40

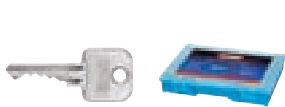

Service Kit



85/20HB22



85/30HB24



85/30HB65



85/40HB40



85/40HB63



85/50HB80



85/50HB127

DIN EN

12320

Kl. 2

85/50



Kl. 1

85/50



### TECHNOLOGY AND FEATURES

- Solid lock body made from brass
- Hardened steel shackle with NANO PROTECT™ plating for extreme corrosion resistance
- Can be made keyed alike to already existing keys/locks by the trade (Version Service)
- Double bolted (as of 30 mm)
- Automatic locking: Locking without key by pushing down the shackle
- Paracentric keyway for increased protection against manipulation
- Inner components made from rust-free high quality materials
- Precision pin cylinder with mushroom pins
- WY: With security card: Your security card is needed when ordering original ABUS extra keys and padlocks.





### CARACTÉRISTIQUES TECHNIQUES

- Boîtier en laiton massif
- Grand nombre d'anses différentes : HB (haute anse), IB (anse INOX), MB (anse laiton)
- Possibilité d'adapter la fermeture aux clés/cadenas existants dans un magasin spécialisé (Version Service)
- Double verrouillage (à partir de 30 mm)
- Fermeture automatique en appuyant sur l'anse, sans clé
- Profil de clé paracentrique pour une protection élevée contre les effractions
- Pièces intérieures en matériaux non-corrosifs
- Cylindre de précision à goupilles
- Anse en acier, cimenté avec technologie NANO PROTECT™
- WY : Avec carte de protection : Les doubles de clé et cadenas originaux d'ABUS sont fabriqués uniquement sur présentation de la carte de protection ABUS.

### CARACTERÍSTICAS TÉCNICAS

- Cuerpo del candado de latón macizo
- Arco endurecido, Arco de acero inoxidable (IB), arco de latón (MB), arco largo (HB)
- Se puede igualar a llaves ya existentes, o candados (Versión de servicio)
- Candado con doble enganche (desde 30 mm)
- Auto-cierre: Cierre del candado mediante presión del arco
- Perfil paracentrico que dificulta la manipulación
- Componentes interiores fabricados con componentes inoxidables de gran calidad
- Cilindro de pitón de precisión
- Nano Protect - Protegidos contra la corrosión
- WY: Con tarjeta de seguridad: Las llaves de repuesto y los candados originales de ABUS solo se fabrican presentando la tarjeta de seguridad de ABUS.

Ref. No. Référence Referencia	EAN 4003318							Weight g Poids g Peso g	Key Blank Ébauche Llave en bruto	Level Degré Nivel	Box Quantity Unité d'emballage Cantidad de cajas
		mm	mm	mm	mm	mm	mm				
85/20	02355 2	21	12	12	3	13	39	52	R 2700 / L 2694	4	6
85/25	02362 0	24	14	15	4	12	44	61	R 2700 / L 2694	4	6
85/30	02369 9	30	17	17	5	14	50	93	R 2701 / L 2695	5	6
85/40	02377 4	40	23	22	6,5	16	62	170	R 2702 / L 2696	6	6
85/50	02385 9	50	29	28	8	17	77	272	R 2703 / L 2697	7	6
85/60	09048 6	60	33	35	10	19	91	460	R 2703 / L 2697	7	3
85/70	09049 3	69,5	38,5	44	11,5	19,5	98	750	L 2698	8	3
85/30 B/EFSP	35432 8	30	17	17	5	14	50	93	R 2701 / L 2695	5	6
85/40 B/EFSP	35433 5	40	23	22	6,5	16	62	170	R 2702 / L 2696	6	6
85/50 B/EFSP	35435 9	50	29	28	8	17	77	272	R 2703 / L 2697	7	6
85/60 B/EFSP	35436 6	60	33	35	10	19	91	460	R 2703 / L 2697	7	6
85/20HB22	02409 2	21	12	22	4	13	48	54	R 2700 / L 2694	4	6
85/30HB24	02410 8	30	17	24	5	14	57	95	R 2701 / L 2695	5	6
85/30HB65	02411 5	30	17	65	5	14	98	113	R 2701 / L 2695	5	3
85/40HB63	09051 6	40	22	62,5	6,5	16	103	193	R 2702 / L 2696	6	3
85/40HB40	09050 9	40	22	39	6,5	16	79	172	R 2702 / L 2696	6	3
85/40HB40	02412 2	40	23	40	6,5	16	79	172	R 2702 / L 2696	6	3
85/40HB63	02416 0	40	23	63	6,5	15	102	193	R 2702 / L 2696	6	3
85/50HB80	02417 7	50	29	80	8	17	128	315	R 2703 / L 2697	7	3
85/50HB127	02418 4	50	29	127	8	17	175	351	R 2703 / L 2697	7	3
85/50HB200	02420 7	50	29	200	8	17	248	418	R 2703 / L 2697	7	3

Ref. No. Référence Referencia	EAN 4003318						Weight g Poids g Peso g	Key Blank Ébauche Llave en bruto	Level Degré Nivel	Box Quantity Unité d'emballage Cantidad de cajas	
		mm	mm	mm	mm	mm					mm
85/40HB63 B/EFSP	35434 2	40	23	63	6,5	15	102	193	R 2702 / L 2696	6	6
85IB/30	04794 7	30	17	17	5	14	50	93	R 2701 / L 2695	5	6
85IB/40	04803 6	40	23	22	6,5	16	62	170	R 2702 / L 2696	6	6
85IB/50	04814 2	50	29	28	8	17	77	272	R 2703 / L 2697	7	6
85IB/60	04823 4	60	35	37	10	20	93	460	R 2703 / L 2697	7	3
85IB/40HB40	04900 2	40	23	40	6,5	16	79	172	R 2702 / L 2696	6	3
85IB/40HB63	12511 9	40	23	63	6,5	15	102	193	R 2702 / L 2696	6	3
85WY/40	79653 1	40	23	22	6,5	16	62	180	79683	6	6
85WY/40HB40	83134 8	40	23	40	6,5	16	79	187	79683	6	3
85WY/40HB63	83135 5	40	23	63	6,5	15	102	198	79683	6	3
85WY/50	79655 5	50	29	28	8	17	77	294	79684	7	6
85WY/50HB80	83136 2	50	29	80	8	17	129	330	79684	7	3
85WYIB/40	82716 7	40	23	22	6,5	16	62	174	79683	6	6
85WYIB/40HB40	82749 5	40	23	40	6,5	16	79	183	79683	6	3
85WYIB/40HB63	82750 1	40	23	63	6,5	15	102	194	79683	6	3
85WYIB/50	82735 8	50	29	28	8	17	77	282	79684	7	6
85/20 Lock-Tag	80619 3	21	12	12	3	13	39	52	R 2700 / L 2694	4	6
85/25 Lock-Tag	80620 9	24	14	15	4	12	44	61	R 2700 / L 2694	4	6
85/30 Lock-Tag	80629 2	30	17	17	5	14	50	93	R 2701 / L 2695	5	6
85/40 Lock-Tag	80630 8	40	23	22	6,5	16	62	170	R 2702 / L 2696	6	6
85/50 Lock-Tag	80631 5	50	29	28	8	17	77	272	R 2703 / L 2697		
85/60 Lock-Tag	80632 2	60	33	35	10	19	91	460	R 2703 / L 2697		
85/70 Lock-Tag	80633 9	69,5	38,5	44	11,5	19,5	98	750	L 2698		
85/40HB40 Lock-Tag	80634 6	40	22	39	6,5	16	79	172	R 2702 / L 2696	6	3
85/40HB63 Lock-Tag	80636 0	40	23	63	6,5	15	102	193	R 2702 / L 2696	6	3
Master Key	43813 4										1
Master Key 85WY	82531 6										1

**SURCHARGE / MAJORATION / RECARGO**

- Keyed alike / S'entrouvrant / Llaves iguales
- Keyed alike as per sample / Fermeture selon échantillon / Cierre según muestra
- up to 49 pcs/jusqu'à 49 pces./hasta 49 pzas.
- as of 50 pcs/à partir de 50 pces./a partir de 50 pzas.



## DIN EN

12320



Kl. 2

Kl. 1

75/40

75/40

## TECHNOLOGY AND FEATURES

- Solid lock body made from brass
- Hardened steel shackle with NANO PROTECT™ plating for extreme corrosion resistance
- High precision reversible keyway with up to 150 000 key differs
- Double bolted
- Self-locking: locking without key by pushing down the shackle
- Paracentric keyway for increased protection against manipulation
- Inner components made from non-corrosive materials

## CARACTÉRISTIQUES TECHNIQUES

- Boîtier en laiton massif
- Anse en acier trempé avec revêtement NANO PROTECT™ pour une protection très élevée contre la corrosion
- Confection de clé réversible ultra-précise. Jusqu'à 150 000 fermetures différentes
- Double verrouillage
- Verrouillage automatique : verrouillage sans clé par enfoncement de l'anse
- Profil de clé paracentrique pour une protection élevée contre les effractions
- Pièces intérieures en matériaux anti-corrosion de qualité

## CARACTERÍSTICAS TÉCNICAS

- El cuerpo del candado está fabricado en latón macizo
- Arco está fabricado en acero especial endurecido
- Arco de acero endurecido con recubrimiento NANO PROTECT™
- Perfil de alta precisión reversible con hasta 150 000 combinaciones de llave diferentes
- Arco de doble enganche
- Auto-cierre: Cierre del candado mediante presión del arco
- Perfil paracéntrico que dificulta la manipulación
- Componentes interiores fabricados con materiales inoxidables



Ref. No. Référence Referencia	EAN 4003318							Weight g Poids g Peso g	Key Blank Ébauche Llave en bruto	Level Degré Nivel	Box Quantity Unité d'emballage Cantidad de cajas
		mm	mm	mm	mm	mm	mm				
75/30	26403 0	30	16,5	17	5	13,5	54	107	26423	5	12
75/40	26408 5	40	22	22,5	6,5	15,5	61,5	160	26423	6	12
75/50	26416 0	50	28	29	8	18	77	286	26424	7	6
75/60	26420 7	60	33,5	34,5	10	19	90,5	426	26424	7	3
75/30 B/EFSP	35152 5	30	16,5	17	5	13,5	54	107	26423	5	6
75/40 B/EFSP	35153 2	40	22	22,5	6,5	15,5	61,5	160	26423	6	6
75/50 B/EFSP	35155 6	50	28	29	8	17,5	77	286	26424	7	6
75/30HB30	27181 6	30	16	30,5	5	13,5	67	112	26423	5	12
75/40HB40	27184 7	40	22	40	6,5	15,5	78	168	26423	6	12
75/40HB63	26846 5	40	22	62,5	6,5	16	101	178	26423	6	12
75/50HB80	26849 6	50	28	80	8	18	128	315	26424	7	6
75/40HB40 B/EFSP	35154 9	40	22	39,5	6,5	15,5	78	168	26423	6	6
75/50HB80 B/EFSP	42347 5	50	28	80	8	18	128	315	26424	7	4
75/30 with 5 keys	26842 7	30	16,5	17	5	13,5	54	107	26423	5	12
75/40 with 5 keys	26843 4	40	22	22,5	7	16,5	61,5	160	26423	6	12
75/50 with 5 keys	26844 1	50	28	29	8	18	77	286	26424	7	6
75/60 with 5 keys	26845 8	60	33,5	34,5	10	19	90,5	426	26424	7	3
75/30 Lock-Tag	80637 7	30	16,5	17	5	13,5	54	107	26423	5	12
75/40 Lock-Tag	80638 4	40	22	22,5	7	16,5	61,5	160	26423	6	12
75/50 Lock-Tag	80639 1	50	28	29	8	18	77	286	26424	7	6
75/60 Lock-Tag	80640 7	60	33,5	34,5	10	19	90,5	426	26424	7	3

## SURCHARGE / MAJORATION / RECARGO

- Keyed alike / S'entrouvrant / Llaves iguales



# 751B

NEVER RUST - WITH REVERSIBLE KEY



DIN EN

12320

Kl. 2

751B/50  
751B/40



Kl. 1

751B/50  
751B/40

## TECHNOLOGY AND FEATURES

- Solid lock body made from brass with nickel pearl coating
- Shackle made from stainless steel
- Highly precise reversible key locking system with up to 150 000 key variations
- 751B/40 + 751B/50: Key-retaining
- 751B/30: self-locking

## CARACTÉRISTIQUES TECHNIQUES

- Boîtier en laiton massif
- Anse en acier
- Confection de clé réversible ultra-précise. Jusqu'à 150 000 fermetures différentes
- 751B/40 + 751B/50 : Fermeture obligatoire
- 751B/30 : Verrouillage automatique

## CARACTERÍSTICAS TÉCNICAS

- Cuerpo de latón cromado
- Arco de acero
- Perfil de alta precisión reversible con hasta 150 000 combinaciones de llave diferentes
- 751B/40 + 751B/50: Cierre obligatorio
- 751B/30: Bloqueo automático



Ref. No. Référence Referencia	EAN 4003318							Weight g Poids g Peso g	Key Blank Ébauche Llave en bruto	Level Degré Nivel	Box Quantity Unité d'emballage Cantidad de cajas
		mm	mm	mm	mm	mm	mm				
751B/30	28635 3	30	16	17	5	13,5	53,5	110	26423	5	12
751B/40	28638 4	40	19,5	23	6,5	16	64	179	26423	6	12
751B/50	28643 8	50	28	29	8	18	76,5	288	26424	7	6

## SURCHARGE / MAJORATION / RECARGO

- Keyed alike / S'entrouvrant / Llaves iguales

# 65 | 65CS

## SOLID BRASS PADLOCK

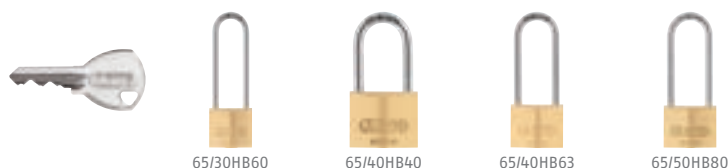

DIN EN

12320

Kl. 2

651B/40



Kl. 1

651B/40



### TECHNOLOGY AND FEATURES

- Solid lock body made from brass
- Hardened steel shackle with NANO PROTECT™ plating for extreme corrosion resistance
- Inner components made from non-corrosive materials
- Precision pin tumbler cylinder
- Shackles available in different lengths (HB)
- CS: shackle guard protects shackle from attack







### CARACTÉRISTIQUES TECHNIQUES

- Boîtier en laiton massif
- Anse en acier cémenté avec technologie NANO PROTECT™
- Pièces intérieures en matériaux non-corrosifs
- Cylindre de précision à goupilles
- Anses disponibles en différentes hauteurs (HB)
- CS : anse blindée : pratiquement inaccessible aux outils d'attaques conventionnels

### CARACTERÍSTICAS TÉCNICAS

- Cuerpo del candado de latón macizo
- Arco fabricado en acero endurecido con recubrimiento NANO PROTECT™
- Componentes interiores fabricados con materiales inoxidables
- Cilindro de pitones de precisión
- Diferentes medidas de arco disponibles (HB)
- CS: Arco protegido para una mayor resistencia a la cizalla y al apalancamiento

Ref. No. Référence Referencia	EAN 4003318							Weight g Poids g Peso g	Key Blank Ébauche Llave en bruto	Level Degré Nivel	Box Quantity Unité d'emballage Cantidad de cajas
		mm	mm	mm	mm	mm	mm				
65/20	02318 7	20	9	11	4	10	34	36	11405	3	12
65/25	02324 8	25	13	13	4	12	42	63	11406	3	12
65/30	02330 9	30	15	17	5	14	50	92	12021	4	12
65/35	02833 5	35	20	19	6	15	55	118	12021	4	12
65/40	02337 8	40	22	22	6,5	15	62	160	12022	5	12
65/45	02787 1	45	25	24	7	16	68	201	12022	5	6
65/50	02344 6	50	28	29	8	18	77	293	12023	6	6
65/60	08751 6	60	34	35	10	19	91	433	12023	6	6
65MB/15	09325 8	16	8	12	3	10	32	26	R 09329 / L 09328	3	12
65/30 B/EFSP	09850 5	30	15	17	5	14	50	92	12021	4	6
65/35 B/EFSP	09851 2	35	20	19	6	15	55	118	12021	4	6
65/40 B/EFSP	09852 9	40	22	22	6,5	15	62	160	12022	5	6
65/45 B/EFSP	09853 6	45	25	24	7	16	68	201	12022	5	6
65/50 B/EFSP	09854 3	50	28	29	8	18	77	293	12023	6	6
65/30HB60	12294 1	30	16	60	5	14	93	110	12021	4	12
65/40HB40	04775 6	40	22	40	6,5	15	77	171	12022	5	12
65/40HB63	04778 7	40	22	63	6,5	15	103	183	12022	5	12
65/50HB80	04781 7	50	28	80	8	18	129	323	12023	6	6
65/40HB40 B/EFSP	09856 7	40	22	40	6,5	15	77	171	12022	5	6
65/40HB63 B/EFSP	09857 4	40	22	63	6,5	15	103	183	12022	5	6
65/50HB80 B/EFSP	09858 1	50	28	80	8	18	129	323	12023	6	6

Ref. No. Référence Referencia	EAN 4003318	 mm	 mm	 mm	 mm	 mm	 mm	Weight g Poids g Peso g	Key Blank Ébauche Llave en bruto	Level Degré Nivel	Box Quantity Unité d'emballage Cantidad de cajas
65/30 Twins B/EFSP	21730 2	30	15	17	5	14	50	92	12021	4	6
65/40 Twins B/EFSP	09859 8	40	22	22	6,5	15	62	160	12022	3	6
651B/40 B/EFSP	11854 8	40	22	22	6,5	15	62	178	12022	5	6
651B/40 Twins B/EFSP	11855 5	40	22	22	6,5	15	62	178	12022	5	6
65CS/40 B/EFSP	35829 6	40	14	18	7	15	60	216	12022	5	6
65CS/50 B/EFSP	35830 2	50	19	21	8	18	77	363	12023	5	6

**SURCHARGE / MAJORATION / RECARGO**

• Keyed alike / S'entrouvrant / Llaves iguales

## BRASS PADLOCK



55/40HB63



### TECHNOLOGY AND FEATURES

- Body made of solid brass
- Inner components made of non-corrosive materials
- Shackle made from hardened steel
- Precision pin tumbler cylinder
- Self-locking: locking without key by pushing down the shackle

### CARACTÉRISTIQUES TECHNIQUES

- Boîtier en laiton massif
- Pièces intérieures en matériaux non corrosifs
- Anse en acier cémenté
- Cylindre de précision à goupilles en forme de tête de champignon
- Verrouillage automatique: pas besoin de clé, il suffit de faire entrer l'anse dans la base

### CARACTERÍSTICAS TÉCNICAS

- Cuerpo construido en sólido latón
- Componentes interiores construidos en materiales resistentes a la corrosión
- Arco endurecido
- Cilindro de pins de precisión
- Bloqueo automático: bloqueo sin llave presionando hacia abajo el soporte

Ref. No. Référence Referencia	EAN 4003318							Weight g Poids g Peso g	Key Blank Ébauche Llave en bruto	Level Degré Nivel	Box Quantity Unité d'emballage Cantidad de cajas
		mm	mm	mm	mm	mm	mm				
55/25	02853 3	24	12	11	4	10	38	48	02879	2	12
55/30	02854 0	29	15	13	5	12	44	81	35491	3	12
55/35	02855 7	33	18	16	5	12	47	93	35491	3	12
55/40	02856 4	38	21	22	6	13	60	144	35490	4	12
55/45	02857 1	43	24	24	6	13	63	160	35490	4	6
55/50	02858 8	48	25	24	7	14	68	216	35490	5	6
55/60	02859 5	58	32	32	8	16	84	327	35490	6	6
55/40HB63	04762 6	38	21	63	6	13	103	164	35490	4	6

### SURCHARGE / MAJORATION / RECARGO

- Keyed alike / S'entrouvrant / Llaves iguales



841B/30HB30



841B/40HB40



841B/50HB50



### TECHNOLOGY AND FEATURES

- Lock body made from solid brass
- Inner components made from rustfree, high quality materials
- Shackle made from stainless steel
- Precision pin cylinder
- Self-locking: locking without key by pushing down the shackle

### CARACTÉRISTIQUES TECHNIQUES

- Boîtier en laiton massif
- Pièces intérieures en matériaux anti-corrosion de qualité
- Anse en acier inox
- Cylindre de précision à goupilles
- Fermeture automatique en appuyant sur l'anse, sans clé

### CARACTERÍSTICAS TÉCNICAS

- Cuerpo del candado de latón macizo
- Partes interiores de materiales anticorrosivos de alta calidad
- Arco de acero inoxidable
- Cilindro de perno de precisión
- Bloqueo automático: se puede bloquear sin la llave presionando hacia abajo el arco

Ref. No. Référence Referencia	EAN 4003318							Weight g Poids g Peso g	Key Blank Ébauche Llave en bruto	Level Degré Nivel	Box Quantity Unité d'emballage Cantidad de cajas
		mm	mm	mm	mm	mm	mm				
841B/30	20387 9	29	14,5	14,5	5	13	49,5	90	00682	3	6
841B/40	20392 3	38	20,5	21	6	13	60,5	130	08365	4	6
841B/50	20395 4	48	25,5	24,5	7	13,5	69	222	08364	5	6
841B/30 B/EFSP	35179 2	29	14,5	14,5	5	13	49,5	90	00682	3	6
841B/40 B/EFSP	32184 9	40	20,5	21	6	13	60,5	130	08365	4	6
841B/50 B/EFSP	32186 3	48	25,5	24,5	7	13,5	69	190	08364	5	6
841B/30HB30	23430 9	29	14	30	5	13	64	84	00682	3	6
841B/40HB40	23431 6	40	20,5	40	6	13	78,5	140	08365	4	6
841B/50HB50	23432 3	48	25,5	50	7	13,5	94	208	08364	5	6
841B/30HB30 B/EFSP	35182 2	29	14	30	5	13	64	84	00682	3	6
841B/40HB40 B/EFSP	35187 7	40	20,5	40	6	13	78,5	140	08365	4	6
841B/50HB50 B/EFSP	32187 0	48	25,5	50	7	13,5	94	208	08364	5	6
841B/40 Twins B/EFSP	37713 6	38	20,5	21	6	13	60,5	130	08365	4	6

### SURCHARGE / MAJORATION / RECARGO

- Keyed alike / S'entrouvrant / Llaves iguales

# 70 | 70IB

THE PERFECT LOCK FOR OUTDOOR USE



## DIN EN

12320

Kl. 2

70IB/45



Kl. 1

70IB/45



## TECHNOLOGY AND FEATURES

- Solid lock body made from brass
- Shackle made from hardened steel with plastic sleeve
- Sealed lock body with special protective cap and drainage channels to protect the locking mechanism from water and dirt
- Shock-absorbing plastic casing protects sensitive surfaces
- Double bolted
- Precision pin cylinder
- Paracentric key profile for increased protection against manipulation
- Inner components made from rust-free materials
- Self-locking: lock without the key by pushing down the shackle







## CARACTÉRISTIQUES TECHNIQUES

- Boîtier en laiton massif
- Anse en acier trempé avec gaine plastique
- Boîtier encapsulé avec clapet protecteur spécial et canaux de drainage pour la protection de la serrure contre l'eau et la saleté
- Une gaine plastique résiliente protège les surfaces sensibles
- Double verrouillage
- Boîtier encapsulé avec clapet protecteur spécial et canaux de drainage pour la protection de la serrure contre l'eau et la saleté
- Profil de clé paracentrique pour une protection élevée contre les effractions
- Pièces intérieures en matériaux inoxydables
- Verrouillage automatique: verrouillage sans clé par enfoncement de l'anse

## CARACTERÍSTICAS TÉCNICAS

- Cuerpo de latón macizo
- Cilindro de pitones de precisión
- Cuerpo del candado sellado por recubrimiento para protección contra el agua y suciedad con canales de drenaje
- Envoltura de vinilo para absorción de golpes
- Candado con doble enganche
- Cilindro de pitones de precisión
- Perfil paracentrico par evitar la manipulacion
- Arco de acero endurecido y forrado en vinilo
- Bloqueo automático: bloqueo sin llave presionando hacia abajo el soporte

Ref. No. Référence Referencia	EAN 4003318							Weight g Poids g Peso g	Key Blank Ébauche Llave en bruto	Level Degré Nivel	Box Quantity Unité d'emballage Cantidad de cajas
		mm	mm	mm	mm	mm	mm				
70/35 yellow	53970 1	34	13,5	24,5	6,5	17	64	91	12021	4	6
70/35 red	53972 5	34	13,5	24,5	6,5	17	64	91	12021	4	6
70/35 black	53971 8	34	13,5	24,5	6,5	17	64	91	12021	4	6
70/45	23144 5	49	20	25	8	28	74	193	12022	5	6
70/50	42680 3	55	23,5	26	9	31	76	239	12022	6	6
70/35 Color B/EFSP	53974 9	34	13,5	24,5	6,5	17	64	91	12021	4	6
70/45 B/EFSP	35148 8	49	21	25	8	28	74	164	12022	5	6
70/50 B/EFSP	42731 2	55	23,5	27	9	31	81	218	12022	6	6
70/45HB63	26765 9	49	21	63	8	28	112	210	12022	5	6
70/45HB63 B/EFSP	32384 3	49	21	63	8	28	112	210	12022	5	6
70/35 Triples Color B/EFSP	54849 9	34	13,5	24,5	6,5	17	64	91	12021	4	3
70/45 Lock-Tag	81428 0	49	20	25	8	28	74	193	12021	5	6
70/50 Lock-Tag	81429 7	55	23,5	26	9	31	76	239	12022	6	6
70IB/35	04773 2	36	14,5	25	6,5	19	65	106	12021	4	12
70IB/45	24987 7	49	21	25	8	28	74	193	12022	5	6
70IB/50	42684 0	55	23,5	27	9	31	81	217	12022	6	6
70IB/35 B/EFSP	04791 6	36	14,5	25	6,5	19	65	106	12021	4	6
70IB/45 B/EFSP	32182 5	49	21	25	8	28	74	193	12022	5	6
70IB/50 B/EFSP	42732 9	55	23,5	27	9	31	81	217	12022	6	6
70IB/45HB63	36609 3	49	20	63	8	28	112	210	12022	5	6
70IB/50HB80	50657 4	55	23	80	9	31	135	298	12022	5	6

Ref. No. Référence Referencia	EAN 4003318	 mm	 mm	 mm	 mm	 mm	 mm	Weight g Poids g Peso g	Key Blank Ébauche Llave en bruto	Level Degré Nivel	Box Quantity Unité d'emballage Cantidad de cajas
70IB/45HB63 B/EFSP	35835 7	49	21	63	8	28	112	210	12022	5	6
70IB/50HB80 B/EFSP	50660 4	55	23,5	80	9	31	134	298	12022	5	6
70IB/35 Lock-Tag	81425 9	36	14,5	25	6,5	19	65	106	12021	4	12
70IB/45 Lock-Tag	81426 6	49	21	25	8	28	74	193	12022	5	6
70IB/50 Lock-Tag	81427 3	55	23,5	27	9	31	81	217	12022	6	6

**SURCHARGE / MAJORATION / RECARGO**

• Keyed alike / S'entrouvrant / Llaves iguales

# 70AL

## ALUMINIUM PADLOCK WITH VINYL COATING



70AL/45 yellow



70AL/45 silver



70AL/45 green



### TECHNOLOGY AND FEATURES

- Solid aluminium body
- Encapsulated lock body with special cover and drainage channels to protect the locking mechanism from water and dirt
- Tough vinyl jacket protects sensitive surfaces
- Shackle made from hardened steel with vinyl jacket
- Inner components made from rustfree material
- Double bolted
- Precision pin cylinder
- Paracentric keyway for increased protection against manipulation
- Self-locking by pushing down the shackle, no key needed

### CARACTÉRISTIQUES TECHNIQUES

- Boîtier très léger en aluminium
- Corps gainé avec cache-entrée de clé et canaux de drainage pour protection par mauvais temps
- Anse en acier cémenté avec gaine plastique
- Socle en PVC: Protection anti-chocs et anti-rayures
- Pièces intérieures en matériaux non-corrosifs
- Double verrouillage
- Cylindre de précision à goupilles
- Profil de clé paracentrique pour une protection élevée contre les effractions
- Verrouillage automatique

### CARACTERÍSTICAS TÉCNICAS

- Cuerpo de aluminio macizo
- Cuerpo del candado sellado con recubrimiento para protección contra el agua y la suciedad con canales de drenaje
- Arco de acero endurecido con envoltura de plástico
- Envoltura de vinilo para absorción de golpes
- Componentes interiores fabricados con materiales inoxidables
- Arco de doble enganche
- Cilindro de pitones de precisión
- Perfil paracéntrico que dificulta la manipulación
- Auto-cierre: Cierre del candado mediante presión del arco

Ref. No. Référence Referencia	EAN 4003318							Weight g Poids g Peso g	Key Blank Ébauche Llave en bruto	Level Degré Nivel	Box Quantity Unité d'emballage Cantidad de cajas
		mm	mm	mm	mm	mm	mm				
70AL/45 yellow	50873 8	49	20	24	8	28	73	127	12022	5	6
70AL/45 green	50874 5	49	20	24	8	28	73	127	12022	5	6
70AL/45 orange	50875 2	49	20	24	8	28	73	127	12022	5	6
70AL/45 silver	50876 9	49	20	24	8	28	73	127	12022	5	6
70AL/45 yellow B/EFSP	50265 1	49	20	24	8	28	73	150	12022	5	4
70AL/45 green B/EFSP	50257 6	49	20	24	8	28	73	150	12022	5	4
70AL/45 orange B/EFSP	50045 9	49	20	24	8	28	73	150	12022	5	4
70AL/45 silver B/EFSP	50261 3	49	20	24	8	28	73	150	12022	5	4
70AL/45 Color B/EFSP	51232 2	49	20	24	8	28	73	150	12022	5	4

### SURCHARGE / MAJORATION / RECARGO

- Keyed alike / S'entrouvrant / Llaves iguales



# 72 | 72IB TITALIUM™

## ANODIZED ALUMINIUM PADLOCKS



### TECHNOLOGY AND FEATURES

- Solid lock body made from TITALIUM™ aluminium alloy
- Shackle made from hardened steel with NANO PROTECT™ plating
- Double bolted
- incl. 2 keys
- Automatic locking: Locking without key by pushing the shackle
- IB: shackle made from stainless steel

### CARACTÉRISTIQUES TECHNIQUES

- Un boîtier en aluminium protégé contre la corrosion
- Anse en acier cémenté
- Corps en laiton anodisé
- Cylindre à 6 goupilles pour un grand nombre de clés différentes
- Verrouillage automatique : verrouillage sans clé par enfacement de l'anse
- IB : anse en acier inox

### CARACTERÍSTICAS TÉCNICAS

- Cuerpo de aluminio anodizado de colores, anticorrosivo
- Arco de acero endurecido con recubrimiento especial NANO PROTECT™
- Cilindro de precisión de 6 pitones, se puede recombinar para igualar a otras llaves
- Candado con doble enganche
- Auto-cierre: Cierre del candado mediante presión del arco
- Cuerpo del candado de aluminio en color - protección anticorrosión
- IB: Arco fabricado en acero inoxidable

Ref. No. Référence Referencia	EAN 4003318							Weight g Poids g Peso g	Key Blank Ébauche Llave en bruto	Level Degré Nivel	Box Quantity Unité d'emballage Cantidad de cajas
		mm	mm	mm	mm	mm	mm				
72/40 blue	43599 7	39	20	27	6,5	19	74	132	20066	6	6
72/40 yellow	43603 1	39	20	27	6,5	19	74	132	20066	6	6
72/40 green	43600 0	39	20	27	6,5	19	74	132	20066	6	6
72/40 purple	43598 0	39	20	27	6,5	19	74	132	20066	6	6
72/40 orange	43601 7	39	20	27	6,5	19	74	132	20066	6	6
72/40 red	43602 4	39	20	27	6,5	19	74	132	20066	6	6
72/40 black	43959 9	39	20	27	6,5	19	74	132	20066	6	6
72/40 blue B/EFSP	46771 4	39	20	27	6,5	19	74	153	20066	6	6
72/40 yellow B/EFSP	46773 8	39	20	27	6,5	19	74	153	20066	6	6
72/40 green B/EFSP	46775 2	39	20	27	6,5	19	74	153	20066	6	6
72/40 purple B/EFSP	46776 9	39	20	27	6,5	19	74	153	20066	6	6
72/40 orange B/EFSP	46778 3	39	20	27	6,5	19	74	153	20066	6	6
72/40 red B/EFSP	46777 6	39	20	27	6,5	19	74	153	20066	6	6
72/40 black B/EFSP	46779 0	39	20	27	6,5	19	74	153	20066	6	6
72/40HB40 blue	43605 5	39	20	39	6,5	19	86	141	20066	6	3
72/40HB40 yellow	43609 3	39	20	39	6,5	19	86	141	20066	6	3
72/40HB40 green	43606 2	39	20	39	6,5	19	86	141	20066	6	3
72/40HB40 purple	43604 8	39	20	39	6,5	19	86	141	20066	6	3
72/40HB40 orange	43607 9	39	20	39	6,5	19	86	141	20066	6	3
72/40HB40 red	43608 6	39	20	39	6,5	19	86	141	20066	6	3
72/40HB40 black	43960 5	39	20	39	6,5	19	86	141	20066	6	3

Ref. No. Référence Referencia	EAN 4003318							Weight g Poids g Peso g	Key Blank Ébauche Llave en bruto	Level Degré Nivel	Box Quantity Unité d'emballage Cantidad de cajas
		mm	mm	mm	mm	mm	mm				
72/40HB40 blue B/EFSP	46781 3	39	20	39	6,5	19	86	160	20066	6	6
72/40HB40 yellow B/EFSP	46782 0	39	20	39	6,5	19	86	160	20066	6	6
72/40HB40 green B/EFSP	46783 7	39	20	39	6,5	19	86	160	20066	6	6
72/40HB40 purple B/EFSP	46785 1	39	20	39	6,5	19	86	160	20066	6	6
72/40HB40 orange B/EFSP	46784 4	39	20	39	6,5	19	86	160	20066	6	6
72/40HB40 red B/EFSP	46780 6	39	20	39	6,5	19	86	160	20066	6	6
72/40HB40 black B/EFSP	46786 8	39	20	39	6,5	19	86	160	20066	6	6
72/40HB75 blue	70555 7	39	20	75	6	19	121	155	20066	6	6
72/40HB75 green	70556 4	39	20	75	6	19	121	155	20066	6	6
72/40HB75 yellow	18692 9	39	20	75	6	19	121	155	20066	6	6
72/40HB75 black	70554 0	39	20	75	6	19	121	155	20066	6	6
72/40HB75 red	18691 2	39	20	75	6	19	121	155	20066	6	6
72/40 blue vs. Lock-Tag	80292 8	39	20	27	6,5	19	74	132	20066	6	6
72/40 brown vs. Lock-Tag	80298 0	39	20	27	6,5	19	74	132	20066	6	6
72/40 yellow vs. Lock-Tag	80294 2	39	20	27	6,5	19	74	132	20066	6	6
72/40 green vs. Lock-Tag	80295 9	39	20	27	6,5	19	74	132	20066	6	6
72/40 purple vs. Lock-Tag	80297 3	39	20	27	6,5	19	74	132	20066	6	6
72/40 red vs. Lock-Tag	80293 5	39	20	27	6,5	19	74	132	20066	6	6
72IB/40 blue	45790 6	39	20	27	6,5	19	74	132	20066	6	6
72IB/40 yellow	45792 0	39	20	27	6,5	19	74	132	20066	6	6
72IB/40 green	45787 6	39	20	27	6,5	19	74	132	20066	6	6
72IB/40 purple	45789 0	39	20	27	6,5	19	74	132	20066	6	6
72IB/40 orange	45791 3	39	20	27	6,5	19	74	132	20066	6	6
72IB/40 red	45788 3	39	20	27	6,5	19	74	132	20066	6	6
72IB/40 black	45786 9	39	20	27	6,5	19	74	132	20066	6	6
72IB/40HB40 blue	45797 5	39	20	39	6,5	19	86	156	20066	6	6
72IB/40HB40 yellow	45799 9	39	20	39	6,5	19	86	156	20066	6	6
72IB/40HB40 green	45794 4	39	20	39	6,5	19	86	156	20066	6	6
72IB/40HB40 purple	45796 8	39	20	39	6,5	19	86	156	20066	6	6
72IB/40HB40 orange	45798 2	39	20	39	6,5	19	86	156	20066	6	6
72IB/40HB40 red	45795 1	39	20	39	6,5	19	86	156	20066	6	6
72IB/40HB40 black	45793 7	39	20	39	6,5	19	86	156	20066	6	6

#### SURCHARGE / MAJORATION / RECARGO

- Keyed alike / S'entrouvrant / Llaves iguales
- Keyed alike as per sample / Fermeture selon échantillon / Cierre según muestra
- Master key function / Clé passe / Funcion llave maestra

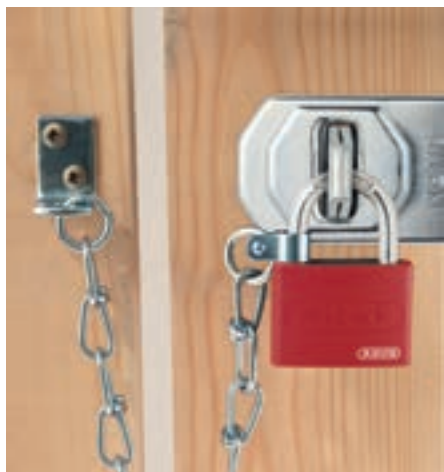

T65AL/40 red

T65AL/40 yellow

T65AL/40 purple

T65AL/40 black

T65AL/40 white

DIN EN  
12320  
Kl. 2



Kl. 1



Kl. 1



Kl. 1



### TECHNOLOGY AND FEATURES

- Lock body made from aluminium
- Hardened steel shackle with NANO PROTECT™ plating for extreme corrosion resistance
- Double bolted
- Individual inscriptions possible for easy identification
- Self-locking: Locking without key by pushing down the shackle
- Paracentric keyway for increased protection against manipulation
- Precision 5-pin tumbler cylinder
- Supplied with two keys

### CARACTÉRISTIQUES TECHNIQUES

- Corps de cadenas en aluminium
- Anse en acier spécial cémenté avec technologie NANO PROTECT™
- Double verrouillage
- Personnalisable : possibilité d'écrire sur la coque avec un marqueur permanent
- Verrouillage automatique : verrouillage sans clé par abaissement de l'anse
- Profil de clé paracentrique pour une protection élevée contre les effractions
- Cylindre de précision à 5 goupilles
- 2 clés incluses

### CARACTERÍSTICAS TÉCNICAS

- Cuerpo del candado de aluminio
- Arco de acero endurecido con recubrimiento NANO PROTECT™
- Candado con cierre de dobe enganche
- Posibilidad de personalizar con un rotulador permanente
- Bloqueo automático: se puede bloquear sin la llave presionando hacia abajo el arco
- Perfil de llave paracentrico para una mayor protección antimanipulación
- Cilindro de pitones de precisión

Ref. No. Référence Referencia	EAN 4003318							Weight g Poids g Peso g	Key Blank Ébauche Llave en bruto	Level Degré Nivel	Box Quantity Unité d'emballage Cantidad de cajas
		mm	mm	mm	mm	mm	mm				
T65AL/40 blue	50867 7	43	22	23	6,5	18	62	102	12022	5	12
T65AL/40 yellow	50868 4	43	22	23	6,5	18	62	102	12022	5	12
T65AL/40 purple	50869 1	43	22	23	6,5	18	62	102	12022	5	12
T65AL/40 red	50870 7	43	22	23	6,5	18	62	102	12022	5	12
T65AL/40 black	50871 4	43	22	23	6,5	18	62	102	12022	5	12
T65AL/40 white	50872 1	43	22	23	6,5	18	62	102	12022	5	12
T65AL/40 blue B/EFSP	50008 4	43	22	23	6,5	18	62	133	12022	5	6
T65AL/40 yellow B/EFSP	50032 9	43	22	23	6,5	18	62	133	12022	5	6
T65AL/40 purple B/EFSP	50023 7	43	22	23	6,5	18	62	133	12022	5	6
T65AL/40 red B/EFSP	50012 1	43	22	23	6,5	18	62	133	12022	5	6
T65AL/40 black B/EFSP	50036 7	43	22	23	6,5	18	62	133	12022	5	6
T65AL/40 white B/EFSP	50723 6	43	22	23	6,5	18	62	133	12022	5	6
T65AL/40 Color B/EFSP	51228 5	43	22	23	6,5	18	62	133	12022	5	6
T65AL/40 blue Lock-Tag	80282 9	43	22	23	6,5	18	62	98	12022	5	6
T65AL/40 yellow Lock-Tag	80284 3	43	22	23	6,5	18	62	98	12022	5	6
T65AL/40 purple Lock-Tag	80285 0	43	22	23	6,5	18	62	98	12022	5	6
T65AL/40 red Lock-Tag	80283 6	43	22	23	6,5	18	62	98	12022	5	6
T65AL/40 black Lock-Tag	80286 7	43	22	23	6,5	18	62	98	12022	5	6
T65AL/40 white Lock-Tag	80287 4	43	22	23	6,5	18	62	98	12022	5	6

### SURCHARGE / MAJORATION / RECARGO

- Keyed alike / S'entrouvrant / Llaves iguales

# 72/40 LOVE LOCK

A PADLOCK AS A SYMBOL OF LOVE

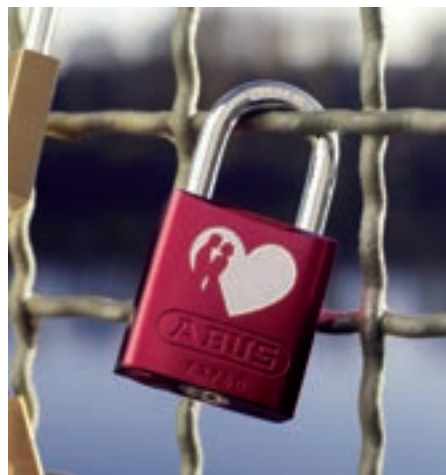

Love Lock 1



Love Lock 2



Love Lock 3



Love Lock 4



Love Lock 5



## TECHNOLOGY AND FEATURES

- Coloured aluminium lock body - corrosion-resistant
- Hardened steel shackle with NANO PROTECT™ plating for extreme corrosion resistance
- One side of the body without coating for large engraving space
- Double bolted
- Self-locking: lock without the key by pushing down the shackle
- Includes two keys

## CARACTÉRISTIQUES TECHNIQUES

- Un boîtier en aluminium protégé contre la corrosion
- Anse en acier cémenté avec technique NANO PROTECT™
- Une face entièrement vide pour les gravures individuelles
- Double verrouillage
- Verrouillage automatique : verrouillage sans clé par enfoncement de l'anse
- Deux clés incluses

## CARACTERÍSTICAS TÉCNICAS

- Cuerpo de de aluminio en color rojo resistente a la corrosión
- Arco endurecido
- Un lado completamente libre para grabados personalizados
- Candado con cierre de doble enganche
- Auto-cierre: cierre del candado mediante presión del arco
- Dos llaves incluidas

Ref. No. Référence Referencia	EAN 4003318							Weight g Poids g Peso g	Key Blank Ébauche Llave en bruto	Level Degré Nivel	Box Quantity Unité d'emballage Cantidad de cajas
		mm	mm	mm	mm	mm	mm				
72/40 red Love Lock 1	09722 5	39	20	27	6,5	19	74	143	20066	6	6
72/40 red Love Lock 2	09737 9	39	20	27	6,5	19	74	143	20066	6	6
72/40 red Love Lock 3	09743 0	39	20	27	6,5	19	74	143	20066	6	6
72/40 red Love Lock 4	09746 1	39	20	27	6,5	19	74	143	20066	6	6
72/40 red Love Lock 5	09748 5	39	20	27	6,5	19	74	143	20066	6	6
72/40 red Love Lock 6	09750 8	39	20	27	6,5	19	74	143	20066	6	6
72/40 color Love Lock red B/EFSP	09666 2	39	20	27	6,5	19	74	143	20066	6	6
72/40 red Love Lock 1 Lock-Tag	80299 7	39	20	27	6,5	19	74	143	20066	6	6
72/40 red Love Lock 2 Lock-Tag	80300 0	39	20	27	6,5	19	74	143	20066	6	6
72/40 red Love Lock 3 Lock-Tag	80301 7	39	20	27	6,5	19	74	143	20066	6	6
72/40 red Love Lock 4 Lock-Tag	80302 4	39	20	27	6,5	19	74	143	20066	6	6
72/40 red Love Lock 5 Lock-Tag	80303 1	39	20	27	6,5	19	74	143	20066	6	6
72/40 red Love Lock 6 Lock-Tag	80304 8	39	20	27	6,5	19	74	143	20066	6	6

# 72LL/40 LOVE LOCK

THE PERFECT LOVELOCK



72LL/40 pink



72LL/40 light green



72LL/40 turquoise



72LL/40 black



## TECHNOLOGY AND FEATURES





- Aluminium lock body and shackle for 100% corrosion resistance
- One side of the body without coining for large engraving space
- 5 vivid colours
- 1 key to seal the love
- Double bolted
- Key retaining

## CARACTÉRISTIQUES TECHNIQUES

- Anse et boîtier en aluminium pour 100% résistance à la corrosion
- Un coté complètement libre pour un gravure individuel
- 5 couleurs intenses
- Une clé pour sceller l'amour
- Clé prisonnière

## CARACTERÍSTICAS TÉCNICAS

- Cuerpo de de aluminio en color rojo resistente a la corrosión
- Una página para grabado individual
- 5 colores
- Una llave para sellar el amor
- Candado de doble enganche

Ref. No. Référence Referencia	EAN 4003318							Weight g Poids g Peso g	Key Blank Ébauche Llave en bruto	Level Degré Nivel	Box Quantity Unité d'emballage Cantidad de cajas
		mm	mm	mm	mm	mm	mm				
72LL/40 red	10068 0	38	20	27	6,5	19	72	105	20066	4	6
72LL/40 pink	10087 1	38	20	27	6,5	19	72	105	20066	4	6
72LL/40 light green	10088 8	38	20	27	6,5	19	72	105	20066	4	6
72LL/40 turquoise	10086 4	38	20	27	6,5	19	72	105	20066	4	6
72LL/40 black	10048 2	38	20	27	6,5	19	72	105	20066	4	6
72LL/40 red Lock-Tag	81261 3	38	20	27	6,5	19	72	105	20066	4	6
72LL/40 pink Lock-Tag	81270 5	38	20	27	6,5	19	72	105	20066	4	6
72LL/40 light green Lock-Tag	81271 2	38	20	27	6,5	19	72	105	20066	4	6
72LL/40 turquoise Lock-Tag	81269 9	38	20	27	6,5	19	72	105	20066	4	6
72LL/40 black Lock-Tag	81259 0	38	20	27	6,5	19	72	105	20066	4	6

# T65AL

IT'S MYLOVE



Back



## TECHNOLOGY AND FEATURES





- High-quality printed vinyl casing to prevent damage
- Individual inscriptions possible for easy identification
- Inner components made from non-corrosive materials
- Special alloy steel shackle with NANO PROTECT™ coating
- Precision pin tumbler cylinder
- Vinyl casing with different casings: heart and beach
- Supplied with two keys

## CARACTÉRISTIQUES TECHNIQUES

- Protection en vinyle gommée de haute qualité pour éviter les rayures
- Personnalisable : possibilité d'écrire sur la coque avec un marqueur permanent
- Pièces intérieures en matériaux non-corrosifs
- Anse en acier spécial cimenté avec technologie NANO PROTECT™
- Cylindre de précision à 5 goupilles
- Protection vinyle avec différents thèmes disponible : cœur, plage
- 2 clés incluses

## CARACTERÍSTICAS TÉCNICAS

- Cuerpo de aluminio macizo
- Cubierta de vinilo impreso de gran calidad para evitar daños
- Posibilidad de inscripciones individuales para una identificación sencilla
- Componentes internos fabricados con materiales no corrosivos
- Arco de aleación de acero especial con recubrimiento NANO PROTECT™
- Cilindro de tambor de pasadores de precisión
- Cubierta de vinilo con diferentes cubiertas: corazón y playa

Ref. No. Référence Referencia	EAN 4003318	 mm	 mm	 mm	 mm	 mm	Weight g Poids g Peso g	Key Blank Ébauche Llave en bruto	Level Degré Nivel	Box Quantity Unité d'emballage Cantidad de cajas
T65AL/40 myLove B/DFNLI	19154 1	43	22	23	6,5	18	61,5	12022	5	6

# 645TI BABY™ LOCK

A LOVE NOTE TO THE OFFSPRING



645TI/30 pink



## TECHNOLOGY AND FEATURES

- Anodized aluminium lock body in light blue and pink
- Back of the lock body is totally empty – enough space for engraving
- 30 mm lock body
- 5 mm hardened steel shackle
- Shackle with NANO PROTECT™ plating for ultimate corrosion resistance
- Individual box packaging (cardboard) in Love Lock Design

## CARACTÉRISTIQUES TECHNIQUES

- Peinture éoxy du cadenas en bleu clair ou rose – une nouveauté mondiale de VHS sans cylindre interchangeable
- Corps de cadenas neutre sur une face pour gravure individuelle
- Corps de cadenas de 30 mm
- Anse en acier trempé de 5 mm
- Traitement Nano Protect™ de l'anse pour une protection optimale contre la corrosion
- Emballage sous étui individuel (design Love Lock)

## CARACTERÍSTICAS TÉCNICAS

- El cuerpo del candado está anodizado en color azul claro y rosa
- Cuerpo del candado neutral por un lado para grabados personalizados
- Cuerpo del candado de 30 mm
- Arco de acero templado de 5 mm
- Acabado Nano Protect™ en el arco para una protección anticorrosión óptima
- Embalaje individual con diseño Love Lock

Ref. No. Référence Referencia	EAN 4003318							Weight g Poids g Peso g	Key Blank Ébauche Llave en bruto	Level Degré Nivel	Box Quantity Unité d'emballage Cantidad de cajas
		mm	mm	mm	mm	mm	mm				
645TI/30 light blue	26357 6	30	16	17	5	10	53	63	12021	4	12
645TI/30 pink	26356 9	30	16	17	5	10	53	63	12021	4	12

# 190CS/60

## HEAVY DUTY COMBINATION LOCK



### TECHNOLOGY AND FEATURES







- 4-digit resettable code
- Stainless steel shackle
- Solid hardened steel jacket
- Precision locking mechanism with special manipulation protection
- Shackle guard protects shackle from attacks

### CARACTÉRISTIQUES TECHNIQUES

- Combinaison interchangeable à 4 molettes
- Boîtier massif en acier trempé
- Anse en acier INOX
- Technique de verrouillage minutieuse: protection élevée contre les manipulations
- Anse blindée : pratiquement inaccessible aux outils d'attaques conventionnels

### CARACTERÍSTICAS TÉCNICAS

- Código numérico personalizable de 4 cifras
- Revestimiento de acero templado
- Arco de acero templado
- Mecanismo de cierre de precisión con protección adicional antimanipulación
- La protección del arco dificulta el acceso con instrumentos para forzar la apertura

Ref. No. Référence Referencia	EAN 4003318	 mm	 mm	 mm	 mm	 mm	 mm	Weight g Poids g Peso g	Level Degré Nivel	Box Quantity Unité d'emballage Cantidad de cajas
190CS/60 B/EFSP	51555 2	62,5	22	30	11,5	35	92,5	770	8	2



# 1801B

THE ALL-WEATHER LOCK WITH RESETTABLE CODE

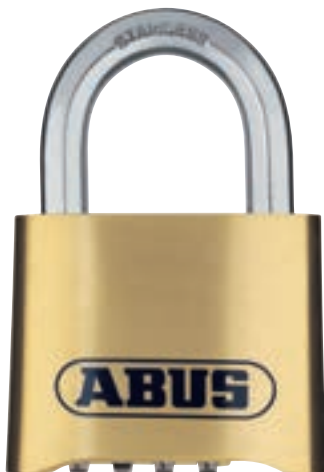

1801B/50HB63



## TECHNOLOGY AND FEATURES

- Body made of solid forged brass
- Shackle made from stainless steel
- 4-digit, individually resettable code
- Inner components made of non-corrosive materials
- Precision locking mechanism with additional tampering protection

## CARACTÉRISTIQUES TECHNIQUES

- Corps en laiton forgé
- Anse en acier inox
- Combinaison interchangeable à 4 molettes
- Pièces intérieures en matériaux non-corrosifs
- Technique de verrouillage minutieuse: protection élevée contre les manipulations

## CARACTERÍSTICAS TÉCNICAS

- Cuerpo de latón macizo
- Arco de acero inoxidable
- Código re-programable de 4 dígitos
- Componentes interiores de materiales no corrosivos
- Mecanismo de cierre de precisión con protección especial contra manipulaciones

Ref. No. Référence Referencia	EAN 4003318							Weight g Poids g Peso g	Level Degré Nivel	Box Quantity Unité d'emballage Cantidad de cajas
		mm	mm	mm	mm	mm	mm			
1801B/50 B/EFSP	32074 3	53	25	25	8	25	75	308	5	6
1801B/50HB63 B/EFSP	32075 0	53	25	63	8	25	113	343	5	6

## COMBINATION PADLOCK WITH RESETTABLE CODE



158/40



158/50



158/50HB50



158/65



158CS/65



158CS/50



### TECHNOLOGY AND FEATURES

- Solid zinc-die cast body
- Shackle made from hardened steel
- Double bolted shackle
- 158/40: individually resettable 3-digit code
- 158/50: individually resettable 4-digit code
- 158/65: individually resettable 5-digit code
- CS: Shackle guard protects shackle from attack

### CARACTÉRISTIQUES TECHNIQUES

- Boîtier robuste en fonte de zinc coulée sous pression
- Anse en acier trempé
- Double verrouillage de l'anse
- 158/40: code personnalisable à 3 chiffres
- 158/50: code personnalisable à 4 chiffres
- 158/65: code personnalisable à 5 chiffres
- CS : anse blindée: pratiquement inaccessible aux outils d'attaques conventionnels

### CARACTERÍSTICAS TÉCNICAS

- Robusto cuerpo de aleación de cinc en fundición de colada por inyección
- Arco de acero endurecido
- Candado con cierre de doble enganche
- 158/40: Código re-programable de 3 dígitos
- 158/50: Código re-programable de 4 dígitos
- 158/65: Código re-programable de 5 dígitos
- CS: la protección de planchado dificulta el acceso por medio de una herramienta de corte

Ref. No. Référence Referencia	EAN 4003318							Weight g Poids g Peso g	Level Degré Nivel	Box Quantity Unité d'emballage Cantidad de cajas
		mm	mm	mm	mm	mm	mm			
158/65	20332 9	63	31	40	10	26	116	455	8	6
158/40 B/EFSP	46800 1	42	24	26	6	21	72	200	4	3
158/50 B/EFSP	35012 2	51	26	32	8	23	96	307	5	3
158/65 B/EFSP	21753 1	63	31	40	10	26	116	535	8	3
158/50HB63	83151 5	52	26	67	8	23	130	290	5	14
158/50HB/50 B/EFSP	08396 9	52	26	57	8	23	120	335	5	6
158CS/50 B/EFSP	72968 3	52	23	27	8	23	96	370	6	3
158CS/65 B/EFSP	72969 0	69	25,5	35	10	26	116	656	9	3

# 158KC

## COMBINATION PADLOCK - WITH OVERRIDE KEY



Override key

Product Video



### TECHNOLOGY AND FEATURES

- Solid body made from zinc die-cast
- Shackle made from hardened steel
- 4-digit resettable code
- Disc cylinder - maximum protection against picking
- Lost code can be easily identified and reset by using override key
- Override key sold separately

### CARACTÉRISTIQUES TECHNIQUES

- Boîtier robuste en zamac
- Anse en acier cémenté
- Combinaison interchangeable à 4 molettes
- Cylindre à disques - très haute protection contre toutes sortes de manipulation
- Le cadenas peut être reprogrammé avec la clé passepartout à tout moment (en cas de code oublié, etc.)
- Passe général vendu séparément
- Disponible en 5 systèmes de fermetures différents avec possibilité de clés passe

### CARACTERÍSTICAS TÉCNICAS

- Robusto cuerpo de aleación de cinc en fundición de colada por inyección (die cast)
- Arco de acero endurecido
- Código re-programable de 4 dígitos
- Función de tecla maestra por cilindro de disco
- La llave maestra se vende por separado
- Disponible en 5 HS-cierres diferentes

Ref. No. Référence Referencia	EAN 4003318							Weight g Poids g Peso g	Level Degré Nivel	Box Quantity Unité d'emballage Cantidad de cajas
		mm	mm	mm	mm	mm	mm			
158KC/45 AP050	55673 9	45	20	25	6	19	81	177	5	12
158KC/45 AP051	55697 5	45	20	25	6	19	81	177	5	12
158KC/45 AP052	55698 2	45	20	25	6	19	81	177	5	12
158KC/45 AP053	55699 9	45	20	25	6	19	81	177	5	12
158KC/45 AP054	55700 2	45	20	25	6	19	81	177	5	12
Master key AP050	55704 0									1
Master key AP051	55705 7									1
Master key AP052	55706 4									1
Master key AP053	55707 1									1
Master key AP054	55708 8									1

## COMBINATION PADLOCK WITH RESETTABLE CODE



160/40



160/50HB50



### TECHNOLOGY AND FEATURES

- Lock body and shackle in exclusive high-gloss chrome plating
- Shackle made from hardened steel
- Double bolted
- 160/40: individually resettable 3-digit code
- 160/50: individually resettable 4-digit code

### CARACTÉRISTIQUES TECHNIQUES

- Boîtier et anse en chrome brillant exclusif
- Anse en acier trempé
- Double verrouillage
- 160/40: code personnalisable à 3 chiffres
- 160/50: code personnalisable à 4 chiffres

### CARACTERÍSTICAS TÉCNICAS

- Exclusivo acabado del cuerpo y arco en cromo pulido para gran resistencia a la intemperie
- Arco de acero endurecido
- Candado con doble enganche
- 160/40: Código re-programable de 3 dígitos
- 160/50: Código re-programable de 4 dígitos

Ref. No. Référence Referencia	EAN 4003318							Weight g Poids g Peso g	Level Degré Nivel	Box Quantity Unité d'emballage Cantidad de cajas
		mm	mm	mm	mm	mm	mm			
160/40 B/EFSP	32933 3	42	24	22	6	18	71	141	5	6
160/50 B/EFSP	32076 7	50	29	26	7,5	19	86	201	6	6
160/50HB50 B/EFSP	35839 5	50	29	50	7,5	19	110	213	6	6

# 78 | 78KC

## COMBINATION LOCK WITH DIAL LOCKING MECHANISM



78KC/50



78KC/50 Back



Product Video



### TECHNOLOGY AND FEATURES

- Shackle made from hardened steel
- 78KC: Master key opens more than 2 000 individual combinations (master key function by cylinder on the back of the lock)
- High protection against manipulation
- KTL-coating (black) for better corrosion protection

### CARACTÉRISTIQUES TECHNIQUES

- Anse en acier trempé
- 78KC: La clé principale ouvre plus de 2 000 combinaisons différentes (fonction clé principale via le cylindre au dos)
- Protection élevée contre les effractions
- Revêtement KTL pour une meilleure protection anti-corrosion

### CARACTERÍSTICAS TÉCNICAS

- Arco fabricado de acero endurecido
- 78KC: Control de llave - el cilindro de pitones tiene una función de llave maestra, ideal para colegios
- Gran protección contra manipulaciones
- Recubrimiento KTL para una buena protección contra la corrosión

Ref. No. Référence Referencia	EAN 4003318							Weight g Poids g Peso g	Level Degré Nivel	Box Quantity Unité d'emballage Cantidad de cajas
		mm	mm	mm	mm	mm	mm			
78/50 B/EFSP	35160 0	50	21	21	7	32	76	154	3	6
78KC/50 KC507	47670 9	50	21	21	7	32	76	185	3	12
78KC/50 KC510	47695 2	50	21	21	7	32	76	185	3	12
HS/MK/PP No. 507	24854 2									1
HS/MK/PP No. 510	24857 3									1

# 155 | 155 BLACK & WHITE

## COMBINATION LOCK WITH RESETTABLE CODE



155/20



155/30



155/20 white



155/20 black



### TECHNOLOGY AND FEATURES

- Strong zinc-die cast body with hardened steel shackle
- 155/20 and 155/30: individually resettable 3-digit code
- 155/40: individually resettable 4-digit code

### CARACTÉRISTIQUES TECHNIQUES

- Boîtier robuste en zinc coulé sous pression avec anse en acier
- 155/20 et 155/30: code personnalisable à 3 chiffres
- 155/40: code personnalisable à 4 chiffres

### CARACTERÍSTICAS TÉCNICAS

- Arco de acero endurecido
- 155/20 y 155/30: Código re-programable de 3 dígitos
- 155/40: Código re-programable de 4 dígitos

Ref. No. Référence Referencia	EAN 4003318							Weight g Poids g Peso g	Level Degré Nivel	Box Quantity Unité d'emballage Cantidad de cajas
		mm	mm	mm	mm	mm	mm			
155/20	30888 8	22	9	19	3	14	54	40	3	6
155/30	30889 5	34	14	19	5	16	60	70	3	6
155/40	30890 1	44	19	26	6	18	80	145	4	6
155/20 B/EFSP	33720 8	22	9	19	3	14	54	40	3	6
155/30 B/EFSP	35003 0	34	14	19	5	16	60	70	3	6
155/40 B/EFSP	35005 4	44	19	26	6	18	80	145	4	6



165/20



165/30

**TECHNOLOGY AND FEATURES**

- Brass lock body
- Steel shackle
- 165/20 and 165/30: individually resettable 3-digit code
- 165/40: individually resettable 4-digit code
- Spring loaded shackle for a better setting of the opening code

**CARACTÉRISTIQUES TECHNIQUES**

- Boîtier en laiton
- Anse en acier
- 165/20 et 165/30: code personnalisable à 3 chiffres
- 165/40: code personnalisable à 4 chiffres
- L'anse est sur ressort pour un meilleur ajustement de la combinaison d'ouverture

**CARACTERÍSTICAS TÉCNICAS**

- Cuerpo de latón
- Arco de acero
- 165/20 y 165/30: Código re-programable de 3 dígitos
- 165/40: Código re-programable de 4 dígitos
- Soporte de resorte para un mejor ajuste de la combinación de apertura

Ref. No. Référence Referencia	EAN 4003318							Weight g Poids g Peso g	Level Degré Nivel	Box Quantity Unité d'emballage Cantidad de cajas
		mm	mm	mm	mm	mm	mm			
165/20	20359 6	23	9	22	3	14	53	48	3	6
165/30	20360 2	32	14	25	5	16	65	108	3	6
165/40	20361 9	42	22	27	6	17	77	222	4	6
165/20 B/EFSP	32161 0	23	9	22	3	14	53	69	3	6
165/30 B/EFSP	32162 7	32	14	25	5	16	65	126	3	6
165/40 B/EFSP	32163 4	42	22	27	6	17	77	243	4	6
165/20 Lock-Tag	20359 6	23	9	22	3	14	53	48	3	6
165/30 Lock-Tag	20360 2	32	14	25	5	16	65	108	3	6
165/40 Lock-Tag	20361 9	42	22	27	6	17	77	222	4	6
165/20 Twins B/EFSP	35018 4	23	9	22	3	14	53	69	3	6

# 1651B

## COMBINATION LOCK WITH RESETTABLE CODE



### TECHNOLOGY AND FEATURES







- Nickel-plated brass lock body
- Stainless steel shackle
- Plastic code dials for increased corrosion protection
- 1651B/40: individually adjustable, 4-digit numerical code
- Spring-loaded shackle for better adjustment of the opening combination

### CARACTÉRISTIQUES TECHNIQUES

- Corps du cadenas en laiton nickelé
- Anse en acier inoxydable
- Molettes en plastique pour une meilleure protection anti-corrosion
- 1651B/40 : code numérique à 4 chiffres personnalisable
- Anse à ressort pour un meilleur réglage de la combinaison d'ouverture

### CARACTERÍSTICAS TÉCNICAS

- Cuerpo del candado latonado dorado
- Arco de acero inoxidable
- Ruletas de código de plástico para una mayor protección contra la corrosión
- 1651B/40: código numérico de 4 dígitos personalizable
- Arco con sistema de resorte para un mejor ajuste de la combinación numérica

Ref. No. Référence Referencia	EAN 4003318							Weight g Poids g Peso g	Level Degré Nivel	Box Quantity Unité d'emballage Cantidad de cajas
		mm	mm	mm	mm	mm	mm			
1651B/30 B/JAPAN	90424 0	31	14	25	5	15	65	118	3	12
1651B/40 B/JAPAN	90421 9	41	22	26	6	17	78	217	4	5





145/20 red



145/30 yellow



145/40 orange



145/40 red



145/40 purple



145/40 green



145/40 silver



145/40 titanium



145/40 black



### TECHNOLOGY AND FEATURES

- Solid aluminium lock body with anodized coating – corrosion resistant
- Spring loaded shackle for a better setting of the opening code
- 145/20 and 145/30: Individually resettable 3-digit code
- 145/40: Individually resettable 4-digit code
- Handy operation without key, low weight
- High value of recognition by intensive colour

### CARACTÉRISTIQUES TECHNIQUES

- Boîtier de cadenas massif en aluminium à revêtement anodisé – résistant à la corrosion
- L'anse est sur ressort pour un meilleur ajustement de la combinaison d'ouverture
- 145/20 et 145/30: Code individuel personnalisable à 3 chiffres
- 145/40: Code individuel personnalisable à 4 chiffres
- Utilisation confortable sans clé, poids faible
- Grande facilité d'identification grâce aux couleurs vives

### CARACTERÍSTICAS TÉCNICAS

- Cuerpo de aluminio anodizado de colores, anticorrosivo
- Soporte de resorte para un mejor ajuste de la combinación de apertura
- 145/20 y 145/30: Sistema de combinación re-programable de 3 dígitos
- 145/40: Sistema de combinación re-programable de 4 dígitos
- Fácil de usar sin llave, peso ligero, fácil de detectar con colores intensos
- Alto valor de reconocimiento a través de colores fuertes

Ref. No. Référence Referencia	EAN 4003318							Weight g Poids g Peso g	Level Degré Nivel	Box Quantity Unité d'emballage Cantidad de cajas
		mm	mm	mm	mm	mm	mm			
145/20 black	34611 8	22,5	9	22	3	13,5	52,5	25	3	6
145/20 blue	46605 2	22,5	9	22	3	13,5	52,5	25	3	6
145/20 green	46608 3	22,5	9	22	3	13,5	52,5	25	3	6
145/20 orange	46607 6	22,5	9	22	3	13,5	52,5	25	3	6
145/20 purple	46610 6	22,5	9	22	3	13,5	52,5	25	3	6
145/20 red	46606 9	22,5	9	22	3	13,5	52,5	25	3	6
145/20 silver	46611 3	22,5	9	22	3	13,5	52,5	25	3	6
145/20 titanium	46613 7	22,5	9	22	3	13,5	52,5	25	3	6
145/20 yellow	46609 0	22,5	9	22	3	13,5	52,5	25	3	6
145/30 black	34612 5	31,5	14	26	5	15,5	65	55	3	6
145/30 blue	46614 4	31,5	14	26	5	15,5	65	55	3	6
145/30 green	46617 5	31,5	14	26	5	15,5	65	55	3	6
145/30 orange	46616 8	31,5	14	26	5	15,5	65	55	3	6
145/30 purple	46619 9	31,5	14	26	5	15,5	65	55	3	6
145/30 red	46615 1	31,5	14	26	5	15,5	65	55	3	6
145/30 silver	46620 5	31,5	14	26	5	15,5	65	55	3	6
145/30 titanium	46622 9	31,5	14	26	5	15,5	65	55	3	6
145/30 yellow	46618 2	31,5	14	26	5	15,5	65	55	3	6
145/40 black	34613 2	41,5	21,5	26	6	17,5	77	110	4	6
145/40 blue	48807 8	41,5	21,5	26	6	17,5	77	110	4	6
145/40 green	48810 8	41,5	21,5	26	6	17,5	77	110	4	6

Ref. No. Référence Referencia	EAN 4003318							Weight g Poids g Peso g	Level Degré Nivel	Box Quantity Unité d'emballage Cantidad de cajas
		mm	mm	mm	mm	mm	mm			
145/40 orange	48812 2	41,5	21,5	26	6	17,5	77	110	4	6
145/40 purple	48811 5	41,5	21,5	26	6	17,5	77	110	4	6
145/40 red	48813 9	41,5	21,5	26	6	17,5	77	110	4	6
145/40 silver	48814 6	41,5	21,5	26	6	17,5	77	110	4	6
145/40 titanium	48806 1	41,5	21,5	26	6	17,5	77	110	4	6
145/40 yellow	48809 2	41,5	21,5	26	6	17,5	77	110	4	6
145/20 blue Lock-Tag	46605 2	22,5	9	22	3	13,5	52,5	26	3	6
145/20 green Lock-Tag	46608 3	22,5	9	22	3	13,5	52,5	26	3	6
145/20 orange Lock-Tag	46607 6	22,5	9	22	3	13,5	52,5	26	3	6
145/20 purple Lock-Tag	46610 6	22,5	9	22	3	13,5	52,5	26	3	6
145/20 red Lock-Tag	46606 9	22,5	9	22	3	13,5	52,5	26	3	6
145/20 silver Lock-Tag	46611 3	22,5	9	22	3	13,5	52,5	26	3	6
145/30 blue Lock-Tag	46614 4	31,5	14	26	5	15,5	65	56	3	6
145/30 green Lock-Tag	46617 5	31,5	14	26	5	15,5	65	56	3	6
145/30 orange Lock-Tag	46616 8	31,5	14	26	5	15,5	65	56	3	6
145/30 purple Lock-Tag	46619 9	31,5	14	26	5	15,5	65	56	3	6
145/30 red Lock-Tag	46615 1	31,5	14	26	5	15,5	65	56	3	6
145/30 silver Lock-Tag	46620 5	31,5	14	26	5	15,5	65	56	3	6
145/30 yellow Lock-Tag	46618 2	31,5	14	26	5	15,5	65	56	3	6
145/40 black Lock-Tag	34613 2	41,5	21,5	26	6	17,5	77	108	3	6
145/40 blue Lock-Tag	48807 8	41,5	21,5	26	6	17,5	77	108	3	6
145/40 green Lock-Tag	48810 8	41,5	21,5	26	6	17,5	77	108	3	6
145/40 purple Lock-Tag	48811 5	41,5	21,5	26	6	17,5	77	108	3	6
145/40 red Lock-Tag	48813 9	41,5	21,5	26	6	17,5	77	108	3	6
145/40 silver Lock-Tag	48814 6	41,5	21,5	26	6	17,5	77	108	4	6
145/40 yellow Lock-Tag	48809 2	41,5	21,5	26	6	17,5	77	108	4	6
145/20 black B/DFNLIESP	34599 9	22,5	9	22	3	13,5	52,5	25	3	6
145/20 blue B/DFNLIESP	46568 0	22,5	9	22	3	13,5	52,5	25	3	6
145/20 Color Metal B/DFNLIESP	46629 8	22,5	9	22	3	13,5	52,5	25	3	6
145/20 Color Rainbow B/DFNLIESP	46626 7	22,5	9	22	3	13,5	52,5	25	3	6
145/20 green B/DFNLIESP	46571 0	22,5	9	22	3	13,5	52,5	25	3	6
145/20 orange B/DFNLIESP	46570 3	22,5	9	22	3	13,5	52,5	25	3	6
145/20 purple B/DFNLIESP	46573 4	22,5	9	22	3	13,5	52,5	25	3	6
145/20 red B/DFNLIESP	46569 7	22,5	9	22	3	13,5	52,5	25	3	6
145/20 silver B/DFNLIESP	46574 1	22,5	9	22	3	13,5	52,5	25	3	6
145/20 titanium B/DFNLIESP	46576 5	22,5	9	22	3	13,5	52,5	25	3	6
145/20 yellow B/DFNLIESP	46572 7	22,5	9	22	3	13,5	52,5	25	3	6
145/30 black B/DFNLIESP	34601 9	31,5	14	26	5	15,5	65	55	3	6
145/30 blue B/DFNLIESP	46577 2	31,5	14	26	5	15,5	65	55	3	6
145/30 Color Metal B/DFNLIESP	46635 9	31,5	14	26	5	15,5	65	55	3	6
145/30 Color Rainbow B/DFNLIESP	46632 8	31,5	14	26	5	15,5	65	55	3	6
145/30 green B/DFNLIESP	46580 2	31,5	14	26	5	15,5	65	55	3	6
145/30 orange B/DFNLIESP	46579 6	31,5	14	26	5	15,5	65	55	3	6
145/30 purple B/DFNLIESP	46582 6	31,5	14	26	5	15,5	65	55	3	6
145/30 red B/DFNLIESP	46578 9	31,5	14	26	5	15,5	65	55	3	6
145/30 silver B/DFNLIESP	46583 3	31,5	14	26	5	15,5	65	55	3	6
145/30 titanium B/DFNLIESP	46585 7	31,5	14	26	5	15,5	65	55	3	6
145/30 yellow B/DFNLIESP	46581 9	31,5	14	26	5	15,5	65	55	3	6
145/40 black B/EFSP	34605 7	41,5	21,5	26	6	17,5	77	110	4	6
145/40 blue B/EFSP	49523 6	41,5	21,5	26	6	17,5	77	110	4	6
145/40 Color Metal B/EFSP	49864 0	41,5	21,5	26	6	17,5	77	110	4	6
145/40 Color Rainbow B/EFSP	49865 7	41,5	21,5	26	6	17,5	77	110	4	6
145/40 green B/EFSP	49531 1	41,5	21,5	25	6	17,5	77	110	4	6
145/40 orange B/EFSP	49527 4	41,5	21,5	26	6	17,5	77	110	4	6
145/40 purple B/EFSP	49539 7	41,5	21,5	26	6	17,5	77	110	4	6
145/40 red B/EFSP	48829 0	41,5	21,5	26	6	17,5	77	110	4	6
145/40 silver B/EFSP	49543 4	41,5	21,5	26	6	17,5	77	110	4	6
145/40 titanium B/EFSP	49551 9	41,5	21,5	26	6	17,5	77	110	4	6
145/40 yellow B/EFSP	49535 9	41,5	21,5	26	6	17,5	77	110	4	6



144/30 yellow    144/30 green    144/30 purple    144/30 orange    144/30 rot    144/30 black    144/30 silver    144/30 titanium    144/40 blue



### TECHNOLOGY AND FEATURES

- Solid aluminium lock body with anodised coating
- Abrasion-proof plastic number dials for long-lasting readability and high corrosion protection
- 144/30: individually configurable 3-digit combination
- 144/40: individually configurable 4-digit combination
- Very good readability of the digits due to contrast between numbers and dial
- Easier to use due to extra-large number dials and no need for a key
- Lightweight
- High recognition value due to vivid colours
- Spring-loaded shackle to set the opening combination more easily







### CARACTÉRISTIQUES TECHNIQUES

- Corps du cadenas en aluminium massif avec revêtement anodisé
- Cylindre de chiffres en PVC résistant à l'abrasion pour une lisibilité durable et une très bonne protection contre la corrosion
- 144/30 : code personnel à 3 chiffres programmable
- 144/40 : code personnel à 4 chiffres programmable
- Très bonne lisibilité des chiffres grâce au contraste maximal
- Utilisation facilitée grâce à des cylindres de chiffres de grande taille, sans clé
- Faible poids
- Valeur de reconnaissance élevée grâce à des couleurs intenses
- L'anse est sur ressort pour un meilleur ajustement de la combinaison d'ouverture

### CARACTERÍSTICAS TÉCNICAS

- Candado con cuerpo de aluminio macizo con revestimiento anodizado
- Rodillos numéricos de plástico resistentes al desgaste, para una legibilidad duradera y una excelente protección contra la corrosión
- 144/30: código numérico personalizable de 3 cifras
- 144/40: código numérico personalizable de 4 cifras
- Excelente legibilidad de los dígitos gracias a la máxima relación de contraste
- Manejo más sencillo gracias a los grandes rodillos numéricos, sin llave
- Peso reducido

Ref. No. Référence Referencia	EAN 4003318							Weight g Poids g Peso g	Level Degré Nivel	Box Quantity Unité d'emballage Cantidad de cajas
		mm	mm	mm	mm	mm	mm			
144/30 blue B/EFSP	82190 5	31,5	14	25	5	15,5	65	62	3	6
144/30 yellow B/EFSP	82192 9	31,5	14	25	5	15,5	65	62	3	6
144/30 green B/EFSP	82193 6	31,5	14	25	5	15,5	65	62	3	6
144/30 purple B/EFSP	82194 3	31,5	14	25	5	15,5	65	62	3	6
144/30 orange B/EFSP	82195 0	31,5	14	25	5	15,5	65	62	3	6
144/30 red B/EFSP	82196 7	31,5	14	25	5	15,5	65	62	3	6
144/30 black B/EFSP	82197 4	31,5	14	25	5	15,5	65	62	3	6
144/30 silver B/EFSP	82198 1	31,5	14	25	5	15,5	65	62	3	6
144/30 titanium B/EFSP	82199 8	31,5	14	25	5	15,5	65	62	3	6
144/30 Color Metal B/EFSP	82191 2	31,5	14	25	5	15,5	65	62	3	6
144/30 Color Rainbow B/EFSP	82202 5	31,5	14	25	5	15,5	65	62	3	6
144/40 blue B/EFSP	82535 4	41,5	21,5	26	6	17,5	77	134	4	6
144/40 yellow B/EFSP	82544 6	41,5	21,5	26	6	17,5	77	134	4	6
144/40 green B/EFSP	82547 7	41,5	21,5	26	6	17,5	77	134	4	6
144/40 purple B/EFSP	82550 7	41,5	21,5	26	6	17,5	77	134	4	6
144/40 orange B/EFSP	82553 8	41,5	21,5	26	6	17,5	77	134	4	6
144/40 red B/EFSP	82556 9	41,5	21,5	26	6	17,5	77	134	4	6
144/40 black B/EFSP	82559 0	41,5	21,5	26	6	17,5	77	134	4	6
144/40 silver B/EFSP	82583 5	41,5	21,5	26	6	17,5	77	134	4	6
144/40 titanium B/EFSP	82586 6	41,5	21,5	26	6	17,5	77	134	4	6
144/40 Color Metal B/EFSP	82589 7	41,5	21,5	26	6	17,5	77	134	4	6

Ref. No. Référence Referencia	EAN 4003318							Weight g Poids g Peso g	Level Degré Nivel	Box Quantity Unité d'emballage Cantidad de cajas
		mm	mm	mm	mm	mm	mm			
144/40 Color Rainbow B/EFSP	82592 7	41,5	21,5	26	6	17,5	77	134	4	6
144/30 blue Lock-Tag	80914 9	31,5	14	25	5	15,5	65	57	3	6
144/30 yellow Lock-Tag	80916 3	31,5	14	25	5	15,5	65	57	3	6
144/30 green Lock-Tag	80918 7	31,5	14	25	5	15,5	65	57	3	6
144/30 purple Lock-Tag	80920 0	31,5	14	25	5	15,5	65	57	3	6
144/30 orange Lock-Tag	80922 4	31,5	14	25	5	15,5	65	57	3	6
144/30 red Lock-Tag	80924 8	31,5	14	25	5	15,5	65	57	3	6
144/30 black Lock-Tag	80927 9	31,5	14	25	5	15,5	65	57	3	6
144/30 silver Lock-Tag	80930 9	31,5	14	25	5	15,5	65	57	3	6
144/30 titanium Lock-Tag	80932 3	31,5	14	25	5	15,5	65	57	3	6
144/40 blue Lock-Tag	82372 5	41,5	21,5	26	6	17,5	77	134	4	6
144/40 yellow Lock-Tag	82373 2	41,5	21,5	26	6	17,5	77	134	4	6
144/40 green Lock-Tag	82374 9	41,5	21,5	26	6	17,5	77	134	4	6
144/40 purple Lock-Tag	82375 6	41,5	21,5	26	6	17,5	77	134	4	6
144/40 orange Lock-Tag	82376 3	41,5	21,5	26	6	17,5	77	134	4	6
144/40 red Lock-Tag	82377 0	41,5	21,5	26	6	17,5	77	134	4	6
144/40 black Lock-Tag	82378 7	41,5	21,5	26	6	17,5	77	134	4	6
144/40 silver Lock-Tag	82379 4	41,5	21,5	26	6	17,5	77	134	4	6
144/40 titanium Lock-Tag	82380 0	41,5	21,5	26	6	17,5	77	134	4	6



### TECHNOLOGY AND FEATURES







- Lock body made from plastic
- Cable diameter 2 mm
- Individually resettable 3-digit code
- Write-on name tag included
- Cable shackle opens by pressing the lever on the side
- Visible red indicator at shackle: lock was opened by TSA
- To reset red indicator open lock and turn shackle by 360°

### CARACTÉRISTIQUES TECHNIQUES

- Corps de cadenas en plastique
- Câble de 2 mm de diamètre
- Code personnalisable à 3 chiffres
- Possibilité de personnaliser le cadenas
- Déverrouillage du câble par pression sur un bouton extérieur
- Indicateur rouge visible à l'anse: le cadenas a été ouvert par TSA
- Pour réinitialiser l'indicateur rouge, ouvrir le cadenas et tourner l'anse de 360°

### CARACTERÍSTICAS TÉCNICAS

- Cuerpo del candado de plástico
- Diámetro del cable 2 mm
- Código re-programable de 3 dígitos
- Incluye etiqueta para poder escribir el nombre
- El arco de cable retráctil se abre presionando el botón que hay en el costado
- Indicador rojo en el arco que nos avisa si el candado ha sido abierto en la aduana
- Para resetear el indicador y bajarlo de nuevo hay que abrir el candado y girar el arco 360°

Ref. No. Référence Referencia	EAN 4003318	 mm	 mm	 mm	 mm	 mm	 mm	Weight g Poids g Peso g	Level Degré Nivel	Box Quantity Unité d'emballage Cantidad de cajas
148TSA/30 B	53094 4	30	17	37	2	12,5	93,5	40	2	6

# 147TSA

TSA-ACCEPTED LOCK FOR US ENTRY



## TECHNOLOGY AND FEATURES







- Lock body made from plastic
- Shackle diameter 3 mm
- Individually resettable 3-digit code
- Visible red indicator at shackle: lock was opened by TSA. To reset red indicator open lock and turn shackle by 360°

## CARACTÉRISTIQUES TECHNIQUES

- Corps de cadenas en plastique
- Epaisseur de l'anse 3 mm
- Code personnalisable à 3 chiffres
- Indicateur rouge visible à l'anse: le cadenas a été ouvert par TSA. Pour réinitialiser l'indicateur rouge, ouvrir le cadenas et tourner l'anse de 360°

## CARACTERÍSTICAS TÉCNICAS

- Cuerpo del candado de plástico
- Diámetro del arco 3 mm
- Código re-programable de 3 dígitos
- Indicador rojo en el arco que nos avisa si el candado ha sido abierto en la aduana
- Para resetear el indicador y bajarlo de nuevo hay que abrir el candado y girar el arco 360°

Ref. No. Référence Referencia	EAN 4003318	 mm	 mm	 mm	 mm	 mm	 mm	Weight g Poids g Peso g	Level Degré Nivel	Box Quantity Unité d'emballage Cantidad de cajas
147TSA/30 B	53093 7	33	13	20	3	14	60	28	2	12

# 146TSA

TSA-ACCEPTED LOCK FOR US ENTRY



## TECHNOLOGY AND FEATURES

- Lock body made from plastic
- Shackle diameter 3 mm
- Individually resettable 3-digit code
- 146TSA: Visible red indicator at shackle: lock was opened by TSA
- To reset red indicator open lock and turn shackle by 360°

## CARACTÉRISTIQUES TECHNIQUES

- Corps de cadenas en plastique
- Épaisseur de l'anse : 3 mm
- Code personnalisable à 3 chiffres
- 146TSA: Indicateur rouge visible à l'anse: le cadenas a été ouvert par TSA
- Pour réinitialiser l'indicateur rouge, ouvrir le cadenas et tourner l'anse de 360°

## CARACTERÍSTICAS TÉCNICAS

- Cuerpo del candado de plástico
- Grosor del arco: 3 mm
- Código re-programable de 3 dígitos
- 146TSA: Indicador rojo en el arco que nos avisa si el candado ha sido abierto en la aduana
- Para resetear el indicador y bajarlo de nuevo hay que abrir el candado y girar el arco 360°

Ref. No. Référence Referencia	EAN 4003318						Weight g Poids g Peso g	Level Degré Nivel	Box Quantity Unité d'emballage Cantidad de cajas	
		mm	mm	mm	mm	mm				
146TSA/30 B	57017 9	33	13	19	3	14	60,5	31	2	12
146TSA/30 Twins B	58830 3	33	13	19	3	14	60,5	31	2	6

# 466BM

## TRADITIONAL PADLOCK



### TECHNOLOGY AND FEATURES







- Strong steel lock with tumblers and U-shackle
- Lacquered lock body and brass inner parts for optimum corrosion protection
- Weatherproof coating
- Lock mechanism made of brass
- Pipe key
- Keyhole cover
- Includes two keys

### CARACTÉRISTIQUES TECHNIQUES

- Cadenas robuste en acier, à gâchettes et anse pivotante
- Corps de cadenas verni et mécanisme interne en laiton pour une protection optimale contre la corrosion
- Revêtement résistant aux intempéries
- Mécanisme de verrouillage en laiton
- Clé creuse
- Capuchon de trou de serrure
- Deux clés incluses

### CARACTERÍSTICAS TÉCNICAS

- Candado de acero robusto con cierres y arco giratorio
- Cuerpo pintado y partes interiores de latón para una protección anticorrosión óptima
- Recubrimiento resistente a la intemperie
- Mecanismo de cierre de latón
- Llave hueca
- Cubierta del ojo de la cerradura
- Dos llaves incluidas

Ref. No. Référence Referencia	EAN 4003318	 mm	 mm	 mm	 mm	 mm	 mm	Weight g Poids g Peso g	Key Blank Ébauche Llave en bruto	Level Degré Nivel	Box Quantity Unité d'emballage Cantidad de cajas
466BM/40 vs.	89440 4	40	17	19	5,5	14,5	60	66	02691	3	12
466BM/40 gl.	63838 1	40	17	19	5,5	14,5	60	66	02691	3	12





## KEY GARAGE FOR WALL MOUNTING

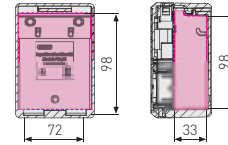
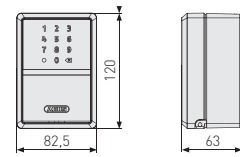

Product Video



### TECHNOLOGY AND FEATURES

- Large, sturdy metal housing
- Illuminated electronic keypad for entering a 6-digit key code
- Manage and use the KeyGarage™ using the HomeTec Pro Bluetooth app
- Generate and send individual access tickets or a 6-digit code for multiple users
- View the log access history and current users
- Capacity for up to 20 keys, 3 car keys or 30 plastic cards
- Integrated key hooks for hanging up keys/key fobs
- Automatic locking
- Battery compartment for 2 x AA batteries, accessible from the outside

### CARACTÉRISTIQUES TECHNIQUES

- Grand boîtier métallique solide
- Clavier de touche électronique éclairé pour la saisie d'un code à 6 chiffres
- Gestion et utilisation de KeyGarage™ via l'application HomeTec Pro Bluetooth
- Génération en envoi de tickets d'accès personnels ou d'un code à 6 caractères pour plusieurs utilisateurs
- Visualisation de l'historique de connexion et des utilisateurs actuels
- Permet de déposer jusqu'à 20 clés, 3 clés de voiture ou 30 cartes plastique
- Crochet à clés intégré pour suspendre des clés/des trousseaux de clés
- Verrouillage automatique
- Logement de pile pour 2 x piles AA, accessible de l'extérieur

### CARACTERÍSTICAS TÉCNICAS

- Sólida carcasa de metal de gran volumen
- Teclado electrónico iluminado para la introducción del código numérico de 6 cifras
- Administración y uso de la KeyGarage™ a través de la app HomeTec Pro Bluetooth
- Generación y envío de tickets personales de acceso o un código de 6 cifras para varios usuarios
- Visualización del historial de registro y usuarios actuales
- Capacidad para hasta 20 llaves, 3 llaves de coche o 30 tarjetas de plástico
- Ganchos para llaves integrados para colgar llaves o manojos de llaves
- Bloqueo automático
- Compartimento de pilas para 2 pilas AA, accesible desde el exterior

Ref. No. Référence Referencia	EAN 4003318	Version Exécution Versión	Finish Coloris Color	Level Degré Nivel	Box Quantity Unité d'emballage Cantidad de cajas
KeyGarage 787 SMART	63824 4	wall mounting	black-silver		1

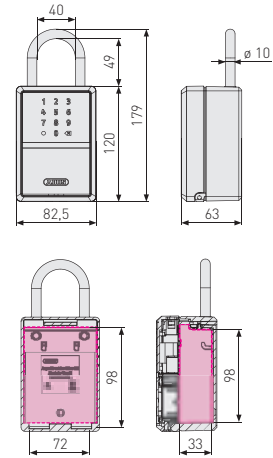

Product Video



### TECHNOLOGY AND FEATURES

- Large, sturdy metal housing
- Illuminated electronic keypad for entering a 6-digit key code
- Manage and use the KeyGarage™ using the HomeTec Pro Bluetooth app
- Generate and send individual access tickets or a 6-digit code for multiple users
- View the log access history and current users
- Capacity for up to 20 keys, 3 car keys or 30 plastic cards
- Integrated key hooks for hanging up keys/key fobs
- Automatic locking
- Battery compartment for 2 x AA batteries, accessible from the outside

### CARACTÉRISTIQUES TECHNIQUES

- Grand boîtier métallique solide
- Clavier de touche électronique éclairé pour la saisie d'un code à 6 chiffres
- Gestion et utilisation de KeyGarage™ via l'application HomeTec Pro Bluetooth
- Génération en envoi de tickets d'accès personnels ou d'un code 6 caractères pour plusieurs utilisateurs
- Visualisation de l'historique de connexion et des utilisateurs actuels
- Permet de déposer jusqu'à 20 clés, 3 clés de voiture ou 30 cartes plastique
- Crochet à clés intégré pour suspendre des clés/des trousseaux de clés
- Verrouillage automatique
- Logement de pile pour 2 x piles AA, accessible de l'extérieur

### CARACTERÍSTICAS TÉCNICAS

- Sólida carcasa de metal de gran volumen
- Teclado electrónico iluminado para la introducción del código numérico de 6 cifras
- Administración y uso de la KeyGarage™ a través de la app HomeTec Pro Bluetooth
- Generación y envío de tickets personales de acceso o un código de 6 cifras para varios usuarios
- Visualización del historial de registro y usuarios actuales
- Capacidad para hasta 20 llaves, 3 llaves de coche o 30 tarjetas de plástico
- Ganchos para llaves integrados para colgar llaves o manojos de llaves
- Bloqueo automático
- Compartimento de pilas para 2 pilas AA, accesible desde el exterior

Ref. No. Référence Referencia	EAN 4003318	Version Exécution Versión	Finish Coloris Color	Level Degré Nivel	Box Quantity Unité d'emballage Cantidad de cajas
KeyGarage 797 SMART	63825 1	with shackle	black-silver		1

# KEYGARAGE™ 787 BIG LED

## KEYGARAGE FOR WALL MOUNTING

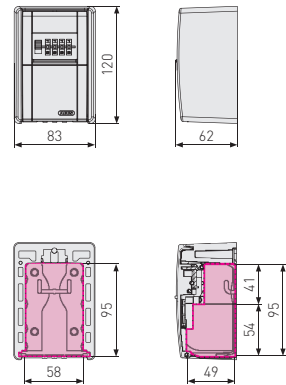

### TECHNOLOGIE

- Solid metal housing
- Locking cover made of zinc die-cast
- 4-digit individually settable code
- Illuminated dials for a better legibility in dark conditions
- LEDs light up ca. 30 seconds
- Customary coin cell battery (CR2032) can be easily replaced, durability of battery when used 1x per day approximately 2 years
- Protective cover with sliding mechanism
- For wall mounting with screws
- Can hold up to 20 keys or 14 code cards
- Easily removable clip-in hooks guarantee consumer's comfort
- Outer dimensions of housing: 84 x 119 x 42

### TECHNOLOGY AND FEATURES

- Boîtier métallique solide
- Capuchon de fermeture en zinc moulé sous pression avec molettes à chiffres
- Code à 4 chiffres personnalisables
- Molette à chiffres éclairée pour une meilleure lisibilité dans les environnements sombres
- Les LED s'allument pendant env. 30 secondes
- Pile bouton standard (CR2032) facile à remplacer, durée de vie en utilisation normale (1x/jour) : env. 2 ans
- Capuchon de protection avec mécanisme coulissant
- Montage mural avec des vis
- Permet de déposer jusqu'à 14 cartes plastiques ou 20 clés
- Crochet à clés amovible pour plus de confort lors du rangement des clés
- Dimensions extérieures du boîtier : 84 x 119 x 42

### CARACTÉRISTIQUES TECHNIQUES

- Sólida carcasa de metal
- Tapa de cierre de cinc fundido a presión con ruedas numéricas
- Código numérico personalizable de 4 cifras
- Cilindro numérico iluminado para una mejor legibilidad en la oscuridad
- Los LED se iluminan durante aprox. 30 segundos
- Pila de botón común (CR2032) fácilmente reemplazable, vida útil con uso normal (1 vez al día) aprox. 2 años
- Tapa protectora con mecanismo deslizante
- Fijación en pared con uniones roscadas
- Capacidad para un total de hasta 14 tarjetas de plástico o 20 llaves
- Gancho extraíble para llaves para un mayor confort al guardar las llaves
- Medidas exteriores de la carcasa: 84 x 119 x 42

Ref. No. Référence Referencia	EAN 4003318	Version Exécution Versión	Finish Coloris Color	Level Degré Nivel	Box Quantity Unité d'emballage Cantidad de cajas
KeyGarage 787 BIG LED	83856 9	wall mounting	black-silver		1

# KEYGARAGE™ 787 BIG

## KEYGARAGE FOR WALL MOUNTING

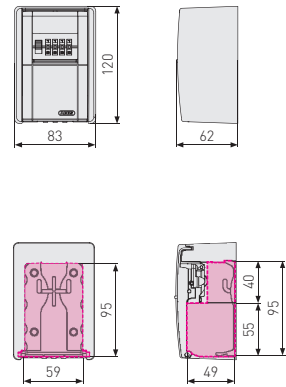

### TECHNOLOGY AND FEATURES

- Very large solid metal housing and extra large storage compartment
  - Locking cover made from zinc die-cast Individually resettable code (4-digit)
  - Protective cover with sliding mechanism
  - For wall mounting with screws
  - Holds up to 30 cards or 50 keys
  - Easily removable clip-in hooks guarantee consumer's comfort
  - Flat inner mechanism makes a larger storage space possible
- Outer dimensions of housing: 84 x 119 x 62

### CARACTÉRISTIQUES TECHNIQUES

- Clapet en zinc coulé sous pression
- Combinaison à 4 chiffres à programmation individuelle
- Clapet d'ouverture coulissant
- Fixation murale avec des vis
- Permet de déposer 30 cartes ou 50 clés
- Le crochet de clé peut être enlevé
- Très large espace de rangement
- Dimensions extérieures du boîtier : 84 x 119 x 62

### CARACTERÍSTICAS TÉCNICAS

- Cubierta de bloqueo manufacturada en fundición de zinc
- Código individual ajustable de 4 dígitos
- Cubierta protectora con mecanismo deslizante
- Fijación en pared con uniones roscadas
- Admite hasta 30 tarjetas o llaves de 50
- Gancho de llave extraíble para mayor comodidad al estibar las llaves Mecanismo interior aplanado para aún más espacio de almacenamiento
- Medidas exteriores de la carcasa: 84 x 119 x 62

Ref. No. Référence Referencia	EAN 4003318	Version Exécution Versión	Finish Coloris Color	Level Degré Nivel	Box Quantity Unité d'emballage Cantidad de cajas
KeyGarage 787 BIG	08492 8	wall mounting	black-silver		1

# KEYGARAGE™ 787 LED

## KEYGARAGE FOR WALL MOUNTING

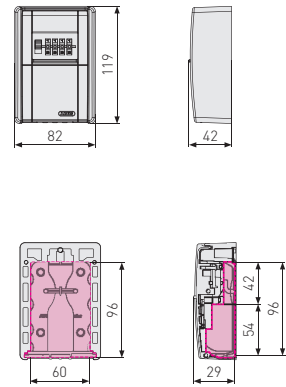

### TECHNOLOGY AND FEATURES

- Solid metal housing
- Locking cover made of zinc die-cast
- 4-digit individually settable code
- Illuminated dials for a better legibility in dark conditions
- LEDs light up ca. 30 seconds
- Customary coin cell battery (CR2032) can be easily replaced, durability of battery when used 1x per day approximately 2 years
- Protective cover with sliding mechanism
- For wall mounting with screws
- Can hold up to 20 keys or 14 code cards
- Easily removable clip-in hooks guarantee consumer's comfort
- Outer dimensions of housing: 84 x 119 x 42

### CARACTÉRISTIQUES TECHNIQUES

- Boîtier métallique solide
- Capuchon de fermeture en zinc moulé sous pression avec molettes à chiffres
- Code à 4 chiffres personnalisables
- Molette à chiffres éclairée pour une meilleure lisibilité dans les environnements sombres
- Les LED s'allument pendant env. 30 secondes
- Pile bouton standard (CR2032) facile à remplacer, durée de vie en utilisation normale (1x/jour) : env. 2 ans
- Capuchon de protection avec mécanisme coulissant
- Montage mural avec des vis
- Permet de déposer jusqu'à 14 cartes plastiques ou 20 clés
- Crochet à clés amovible pour plus de confort lors du rangement des clés
- Dimensions extérieures du boîtier : 84 x 119 x 42

### CARACTERÍSTICAS TÉCNICAS

- Sólida carcasa de metal
- Tapa de cierre de cinc fundido a presión con ruedas numéricas
- Código numérico personalizable de 4 cifras
- Cilindro numérico iluminado para una mejor legibilidad en la oscuridad
- Los LED se iluminan durante aprox. 30 segundos
- Pila de botón común (CR2032) fácilmente reemplazable, vida útil con uso normal (1 vez al día) aprox. 2 años
- Tapa protectora con mecanismo deslizante
- Fijación en pared con uniones roscadas
- Capacidad para un total de hasta 14 tarjetas de plástico o 20 llaves
- Gancho extraíble para llaves para un mayor confort al guardar las llaves
- Medidas exteriores de la carcasa: 84 x 119 x 42

Ref. No. Référence Referencia	EAN 4003318	Version Exécution Versión	Finish Coloris Color	Level Degré Nivel	Box Quantity Unité d'emballage Cantidad de cajas
KeyGarage 787 LED	83854 5	wall mounting	black-silver		1

# KEYGARAGE™ 787

## KEYGARAGE FOR WALL MOUNTING

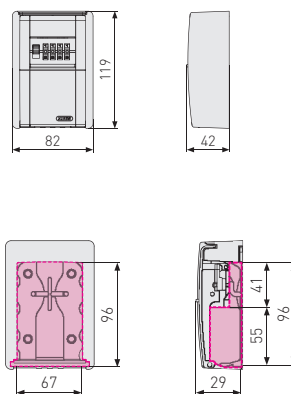

### TECHNOLOGY AND FEATURES

- Solid metal housing
- Locking cover made of zinc die-cast
- 4-digit individually settable code
- Protective cover with sliding mechanism
- For wall mounting with screws
- Can hold up to 20 keys or 14 code cards
- Outer dimensions of housing: 84 x 119 x 42
- Easily removable clip-in hooks guarantee consumer's comfort

### CARACTÉRISTIQUES TECHNIQUES

- Boîtier métallique robuste
- Clapet en zinc coulé sous pression
- Code personnalisable à 4 chiffres
- Clapet de protection avec mécanisme coulissant
- Fixation murale avec des vis
- Permet de déposer 14 cartes ou 20 clés
- Dimensions extérieures du boîtier : 84 x 119 x 42
- Crochet à clés amovible pour plus de confort lors du rangement des clés

### CARACTERÍSTICAS TÉCNICAS

- Solida carcasa de metal
- Cubierta de bloqueo manufacturada en fundición de zinc
- Código individual ajustable de 4 dígitos
- Cubierta protectora con mecanismo deslizante
- Fijación en pared con uniones roscadas
- Admite hasta 14 tarjetas o llaves de 20
- Medidas exteriores de la carcasa: 84 x 119 x 42
- Gancho extraíble para llaves para un mayor confort al guardar las llaves

Ref. No. Référence Referencia	EAN 4003318	Version Exécution Versión	Finish Coloris Color	Level Degré Nivel	Box Quantity Unité d'emballage Cantidad de cajas
KeyGarage 787	46331 0	wall mounting	black-silver		1

# KEYGARAGE™ 797 LED

## SECURED KEY STORAGE

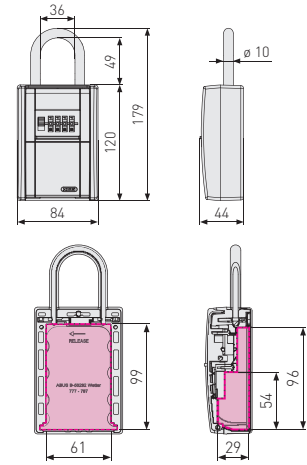
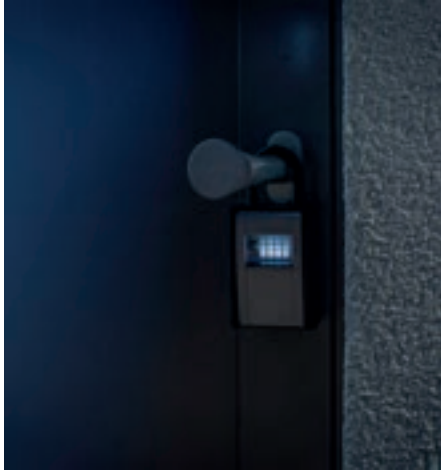

### TECHNOLOGY AND FEATURES

- Solid metal housing
- Locking cover made of zinc die-cast
- 4-digit individually settable code 4-digit
- Illuminated dials for a better legibility in dark conditions
- LEDs light up ca. 30 seconds
- Customary coin cell battery (CR2032) can be easily replaced, durability of battery when used 1x per day approximately 2 years
- Protective cover with sliding mechanism
- Fixing with shackle, e.g. on a door knob of gates and doors
- Can hold up to 20 keys or 14 code cards
- Outer dimensions of housing: 84 x 119 x 44
- Housing and shackle plastic coated (protects door from scratching)

### CARACTÉRISTIQUES TECHNIQUES

- Boîtier en métal solide
- Couvercle de verrouillage en zinc moulé sous pression
- Code à 4 chiffres personnalisables
- Molette à chiffres éclairée pour une meilleure lisibilité dans les environnements sombres
- Les LED s'allument pendant env. 30 secondes
- Pile bouton standard (CR2032) facile à remplacer, durée de vie en utilisation normale (1x/jour) : env. 2 ans
- Capuchon de protection avec mécanisme coulissant
- Avec anse pour une fixation sur la poignée de porte p. ex.
- Capacité de stockage de 14 cartes ou 20 clés
- Dimensions extérieures du boîtier : 84 x 119 x 44
- Boîtier et anse avec revêtement en plastique pour protéger des rayures

### CARACTERÍSTICAS TÉCNICAS

- Sólida carcasa de metal
- Tapa de cierre de cinc fundido a presión con ruedas numéricas
- Código numérico personalizable de 4 cifras
- Cilindro numérico iluminado para una mejor legibilidad en la oscuridad
- Los LED se iluminan durante aprox. 30 segundos
- Pila de botón común (CR2032) fácilmente reemplazable, vida útil con uso normal (1 vez al día) aprox. 2 años
- Tapa protectora con mecanismo deslizante
- Para fijación con arco, p. ej., al pomo de la puerta
- Capacidad para un total de hasta 14 tarjetas de plástico o 20 llaves
- Medidas exteriores de la carcasa: 84 x 119 x 44
- Carcasa y arco con revestimiento plástico adicional para proteger de arañazos

Ref. No. Référence Referencia	EAN 4003318	Version Exécution Versión	Finish Coloris Color	Level Degré Nivel	Box Quantity Unité d'emballage Cantidad de cajas
KeyGarage 797 LED	83855 2	with shackle	black-silver		1



# KEYGARAGE™ 797

## SECURED KEY STORAGE

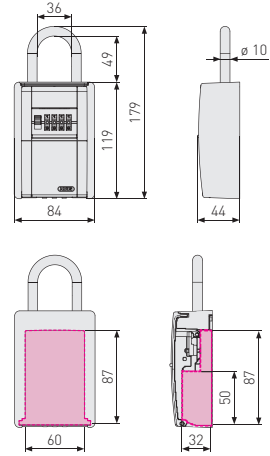

### TECHNOLOGY AND FEATURES

- Solid metal housing
- Locking cover made of zinc die-cast
- 4-digit individually settable code
- Protective cover with sliding mechanism
- Fixing with shackle, e.g. on a door knob of gates and doors
- Can hold up to 20 keys or 14 code cards
- Outer dimensions of housing: 84 x 119 x 44
- Housing and shackle plastic coated (protects door from scratching)

### CARACTÉRISTIQUES TECHNIQUES

- Boîtier métallique robuste
- Clapet en zinc coulé sous pression
- Code personnalisable à 4 chiffres
- Clapet de protection avec mécanisme coulissant
- Avec anse pour une fixation sur la poignée de porte p. ex.
- Permet de déposer 14 cartes ou 20 clés
- Dimensions extérieures du boîtier: 84 x 119 x 44
- Boîtier et anse recouverts de la matière plastique protège ainsi votre porte des rayures

### CARACTERÍSTICAS TÉCNICAS

- Solida carcasa de metal
- Cubierta de bloqueo manufacturada en fundición de zinc
- Código individual reprogramable de 4 dígitos
- Cubierta protectora con mecanismo deslizante
- Para fijación con arco, p. ej., al pomo de la puerta
- Admite hasta 14 tarjetas o llaves de 20
- Medidas exteriores de la carcasa: 84 x 119 x 44
- Carcasa y grillete recubiertos de plástico (protege la puerta de rozaduras)

Ref. No. Référence Referencia	EAN 4003318	Version Exécution Versión	Finish Coloris Color	Level Degré Nivel	Box Quantity Unité d'emballage Cantidad de cajas
KeyGarage 797	46330 3	with shackle	black-silver		1

# KEYGARAGE™ 767

## KEYGARAGE FOR WALL MOUNTING

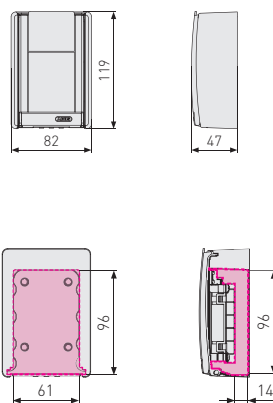

### TECHNOLOGY AND FEATURES

- Solid metal housing
- Locking cover made from zinc die-cast
- Code up to 10 digits individually resettable (the sequence of the code is irrelevant)
- Code needs to be entered in order to close the locking cover
- Plastic cover to protect against dust, dirt, etc.
- For wall fixing with screws
- Holds up to 17 cards or 20 keys
- Outer dimensions of housing: 84 x 119 x 47

### CARACTÉRISTIQUES TECHNIQUES

- Boîtier métallique robuste
- Clapet en zinc coulé sous pression
- Combinaison interchangeable à 10 codes bouton-poussoir: Mettez votre code personnel
- Le code à chiffres doit également être saisi pour fermer le capuchon de fermeture
- Clapet d'ouverture coulissant
- Pour un montage au mur, à l'aide des vis
- Permet de déposer 17 cartes ou 20 clés
- Dimensions extérieures du boîtier: 84 x 119 x 47

### CARACTERÍSTICAS TÉCNICAS

- Solida carcasa de metal
- Tapa protectora bañada en zinc
- Código individual reprogramable (hasta 10 dígitos) – la secuencia del código es irrelevante
- El código numérico debe introducirse también para cerrar la tapa de cierre
- La cubierta integrada de plástico para proteger el panel de las condiciones climáticas externas
- Para fijar a la pared
- Admite hasta 17 tarjetas o llaves de 20
- Medidas exteriores de la carcasa: 84 x 119 x 47

Ref. No. Référence Referencia	EAN 4003318	Version Exécution Versión	Finish Coloris Color	Level Degré Nivel	Box Quantity Unité d'emballage Cantidad de cajas
KeyGarage 767	53507 9	wall mounting	black-silver		1

# KEYGARAGE™ 777

## SECURED KEY STORAGE

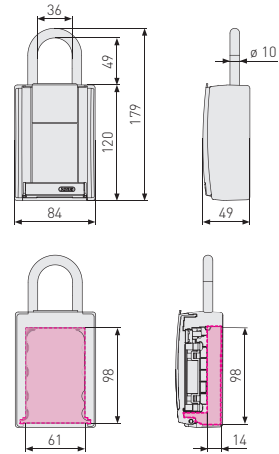

### TECHNOLOGY AND FEATURES

- Solid metal housing
- Locking cover made from zinc die-cast
- Code up to 10 digits individually resettable (the sequence of the code is irrelevant)
- Combination must also be entered for closing
- Plastic cover to protect against dust, dirt, etc.
- Fixing with shackle, e.g. on a door knob of gates and doors
- Can hold up to 20 keys or 14 code cards
- Outer dimensions of housing: 62 x 92 x 37
- Housing and shackle plastic coated (protects door from scratching)

### CARACTÉRISTIQUES TECHNIQUES

- Boîtier métallique robuste
- Clapet en zinc coulé sous pression
- Combinaison interchangeable à 10 codes bouton-poussoir: Mettez votre code personnel
- Combinaison doit être entré pour fermer
- Clapet d'ouverture coulissant
- Avec anse pour une fixation sur la poignée de porte p. ex.
- Permet de déposer 14 cartes ou 20 clés
- Dimensions extérieures du boîtier : 62 x 92 x 37 mm
- Boîtier et anse recouverts de PVC (protège ainsi votre porte des rayures)

### CARACTERÍSTICAS TÉCNICAS

- Solida carcasa de metal
- Cubierta de bloqueo manufacturada en fundición de zinc
- Código re-programable mediante teclado numérico de 10-dígitos
- También se debe ingresar el código de número para cerrar el obturador
- La cubierta integrada de plástico para proteger el panel de las condiciones climáticas externas
- Para fijación con arco, p. ej., al pomo de la puerta
- Admite hasta 14 tarjetas o llaves de 20
- Dimensiones externas de la carcasa: 62 x 92 x 37 mm
- Carcasa y grillete recubiertos de plástico (protege la puerta de rozaduras)

Ref. No. Référence Referencia	EAN 4003318	Version Exécution Versión	Finish Coloris Color	Level Degré Nivel	Box Quantity Unité d'emballage Cantidad de cajas
KeyGarage 777	53508 6	with shackle	black-silver		1

# KEYGARAGE™ 727

## SECURED KEY STORAGE

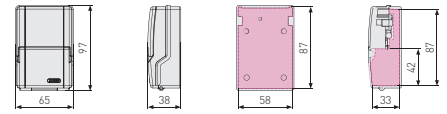

### TECHNOLOGY AND FEATURES

- Solid metal housing
- Locking cover made from zinc die-cast with plastic dials
- Individually resettable code (4-digit)
- Plastic cover protects against moisture and dirt
- For wall mounting with screws
- Compact size with capacity up to 8 keys
- Outer dimensions of housing: 95 x 62 x 38

### CARACTÉRISTIQUES TECHNIQUES

- Capuchon de fermeture en zinc moulé sous pression avec molettes à chiffres en plastique
- Code à 4 chiffres réglable individuellement
- Le capuchon en plastique protège le mécanisme de la pluie et de la saleté
- Fixation murale avec des vis
- Taille compacte pour jusqu'à 8 clés
- Dimensions du boîtier de protection extérieur (H x L x P) 95 mm x 62 mm x 38 mm

### CARACTERÍSTICAS TÉCNICAS

- Tapa de cierre de cinc fundido a presión con ruedas numéricas de plástico
- Código numérico personalizable de 4 cifras
- La tapa de plástico protege el mecanismo numérico de la lluvia y la suciedad
- Fijación en pared con uniones roscadas
- Tamaño compacto para un máximo de 8 llaves
- Medidas de la carcasa exterior (al. x an. x p.) 95 mm x 62 mm x 38 mm



Ref. No. Référence Referencia	EAN 4003318	Version Exécution Versión	Finish Coloris Color	Level Degré Nivel	Box Quantity Unité d'emballage Cantidad de cajas
KeyGarage 727 Mini	77455 3	wall mounting	black-silver		1

# KEYGARAGE™ 737

## SECURED KEY STORAGE

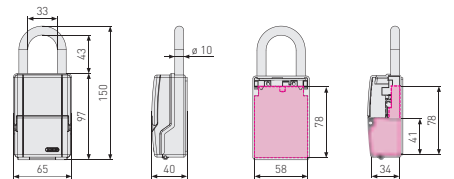

### TECHNOLOGY AND FEATURES

- Solid metal housing
- Locking cover made from zinc die-cast with plastic dials
- Individually resettable code (4-digit)
- Plastic cover protects against moisture and dirt
- Fixing with shackle, e.g. on door knob
- Compact size with capacity up to 8 keys
- Outer dimensions of housing: 95 x 62 x 38
- Housing and shackle plastic coated (protects door from scratching)

### CARACTÉRISTIQUES TECHNIQUES

- Capuchon de fermeture en zinc moulé sous pression avec molettes à chiffres en plastique
- Code personnalisable à 4 chiffres
- Clapet plastique protège contre l'humidité et la saleté
- Avec anse pour une fixation sur la poignée de porte p. ex.
- Taille compacte pour un maximum de 8 clés
- Dimensions du boîtier de protection extérieur (H x L x P) 95 mm x 62 mm x 38 mm
- Boîtier et anse recouverts de la matière plastique protège ainsi votre porte des rayures

### CARACTERÍSTICAS TÉCNICAS

- Tapa de cierre de cinc fundido a presión con ruedas numéricas de plástico
- Combinación re-programable de 4 dígitos
- La cubierta integrada de plástico para proteger el panel de las condiciones climáticas externas
- Para fijación con arco, p. ej., al pomo de la puerta
- Puede guardarse hasta 8 llaves en su interior
- Medida del cuerpo: 95 mm x 62 mm x 38 mm



Ref. No. Référence Referencia	EAN 4003318	Version Exécution Versión	Finish Coloris Color	Level Degré Nivel	Box Quantity Unité d'emballage Cantidad de cajas
KeyGarage 737 Mini	77454 6	with shackle	black-silver		1



# DI141 DISKUS® INTEGRAL

MULTI PURPOSE HASP FOR VANS AND FLUSH DOORS

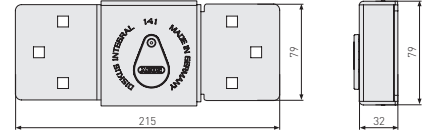

141/200 black



20/70



23/70



25/70



26/70



## TECHNOLOGY AND FEATURES



- Universal hasp with integrated Diskus® padlock (70 mm) for doors and gates without rebate
- Easy to operate with one hand due to handy frontal cylinder access
- Extremely corrosion resistant cylinder
- Solid metal locking case almost completely prevents successful attacks on the integrated padlock
- Interchangeable Diskus® lock
- Fixing material (screws, drilling template and spacers up to 5 mm height levelling) and Diskus® lock are included
- Corrosion protected

## CARACTÉRISTIQUES TECHNIQUES

- Porte-cadenas universel avec un cadenas Diskus® intégré (70 mm), montage sur portes, portails, etc sans feuillure
- Accès facile au système de verrouillage: manipulation à une seule main
- Résistance élevée à la corrosion
- Boîtier solide en acier pour une protection contre les attaques sur le cadenas intégré
- Cadenas Diskus® remplaçable
- Vis, gabarit de montage, cales et cadenas Diskus® inclus dans l'emballage
- Anti-corrosion

## CARACTERÍSTICAS TÉCNICAS

- Cerrojo universal con candado Diskus® integrado (70 mm) para puertas y portones
- Fácil de manejar con una mano gracias al práctico acceso frontal al cilindro
- Cilindro a prueba de salpicaduras
- Una tapa sólida de metal protege completamente de ataques contra el candado integrado
- Candado Diskus® intercambiable
- Incluye accesorios de fijación y candado Diskus®
- Protegidos contra la corrosión

Ref. No. Référence Referencia	EAN 4003318	 mm	 mm	 mm	Weight g Poids g Peso g	Level Degré Nivel	Box Quantity Unité d'emballage Cantidad de cajas
141/200 white	50656 7	222	87,3	13,4	1270	8	1
141/200 black	51439 5	222	87,3	13,4	1270	8	1
141/200+23/70 white B	51522 4	222	87,3	13,4	1570	8	1
141/200+23/70 black B	51963 5	222	87,3	13,4	1570	8	1
141/200+25/70 white B	53827 8	222	87,3	13,4	1570	8	1
141/200+25/70 black B	53826 1	222	87,3	13,4	1570	8	1
141/200+26/70 white B	50655 0	222	87,3	13,4	1570	8	1
141/200+26/70 black B	51440 1	222	87,3	13,4	1570	8	1
141/200+20/70 white B	77365 5	222	87,3	13,4	1570	8	1

# DI142 DISKUS® INTEGRAL

UNIVERSAL HASP FOR SLIDING DOORS AND GATES

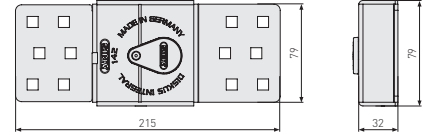

Hasps

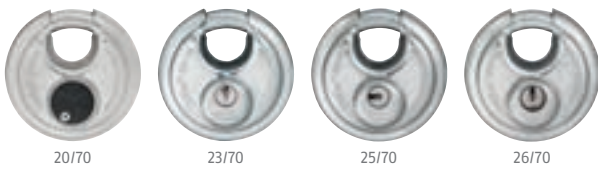

## TECHNOLOGY AND FEATURES



- Double protection: The integrated Diskus® lock (70 mm) is protected all the way around by a solid metal casing – attacks on the integrated lock are nearly impossible
- Easy to operate with one hand due to handy frontal cylinder access
- Cylinder cover - maximum protection against dirt and moisture
- Solid metal locking case almost completely prevents successful attacks on the integrated padlock
- Diskus® lock exchangeable
- Incl. Fixing material

## CARACTÉRISTIQUES TECHNIQUES

- Double protection : le cadenas Diskus® intégré (70 mm) est entièrement protégé par une gâche en métal massive, rendant ainsi les attaques sur le cadenas intégré quasiment impossibles
- Accès facile au système de verrouillage: manipulation à une seule main
- Cache-entrée de clé: Protection optimale contre la saleté
- Boîtier solide en acier protège contre des attaques sur le cadenas intégré
- Le cadenas Diskus® est remplaçable
- Vis, gabarit de montage, cales et cadenas Diskus® inclus dans l'emballage

## CARACTERÍSTICAS TÉCNICAS

- Doble protección: el candado Diskus® (70 mm) integrado está protegido mediante una caja de cierre metálica maciza, haciendo prácticamente imposibles los ataques al candado integrado
- Fácil de manejar con una mano gracias al práctico acceso frontal al cilindro
- Cubierta del cilindro - Máxima protección contra la suciedad y la humedad
- Una tapa sólida de metal protege completamente de ataques contra el candado integrado
- Candado Diskus® intercambiable
- Incluye material de sujeción y candado Diskus®

Ref. No. Référence Referencia	EAN 4003318	 mm	 mm	 mm	Weight g Poids g Peso g	Level Degré Nivel	Box Quantity Unité d'emballage Cantidad de cajas
142/200 white	81888 2	222	87,3	13,4	1270	8	1
142/200 white + 20/70	81889 9	222	87,3	13,4	1620	8	1
142/200 white + 23/70	83978 8	222	87,3	13,4	1570	8	1
142/200 white + 25/70	83979 5	222	87,3	13,4	1620	8	1
142/200 white + 26/70	83983 2	222	87,3	13,4	1620	8	1
141 + 142 + 20/70 gl.	82942 0	222	87,3	13,4	3230	8	1
141 + 142 + 23/70 gl.	86642 5	222	87,3	13,4	3230	8	1
141 + 142 + 25/70 gl.	86465 0	222	87,3	13,4	3230	8	1
141 + 142 + 26/70 gl.	86103 1	222	87,3	13,4	3230	8	1

# 130

## GRANIT™ HASP FOR HIGHEST SECURITY REQUIREMENTS

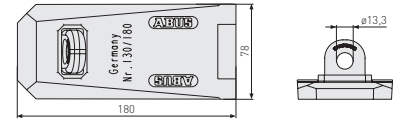

### TECHNOLOGY AND FEATURES

- Two hardened concealed hinge pins
- Tough white heart malleable iron
- Hardened staple
- With anchor plate and accessories
- Hidden screws



### CARACTÉRISTIQUES TECHNIQUES

- Deux gonds renforcés avec protection contre les enfoncements
- Fonte malléable résiliente
- Œillets en acier trempé
- Avec plaque d'ancrage et accessoires
- Vis masquées

### CARACTERÍSTICAS TÉCNICAS

- Articulación de bisagra de doble eje endurecida
- Fabricado en hierro de fundición resistente
- Argolla endurecida
- Incluye tornillos, tuercas y contra-placas de sujeción
- Tornillos escondidos



Ref. No. Référence Referencia	EAN 4003318	 mm	 mm	 mm	Weight g Poids g Peso g	Level Degré Nivel	Box Quantity Unité d'emballage Cantidad de cajas
130/180	07998 6	180	78	13,3	1670	10	2
130/180 B/EFSP	35444 1	180	78	13,3	1670	10	2
Eyelet 130/180	09428 6				154		1

# 125

## HASP



### TECHNOLOGY AND FEATURES

- Extra strong hinge
- Hardened staple
- Including coach bolts and back plates
- Corrosion protected
- Hidden screws



### CARACTÉRISTIQUES TECHNIQUES

- Articulation très robuste
- Œillets cémentés
- Livré avec la contre-plaque et les accessoires
- Protection contre la corrosion
- Vis masquées

### CARACTERÍSTICAS TÉCNICAS

- Articulación extrafuerte
- Argolla endurecida
- Con placa de encaje y accesorios
- Gran protección contra la corrosión
- Tornillos escondidos



Ref. No. Référence Referencia	EAN 4003318	 mm	 mm	 mm	Weight g Poids g Peso g	Level Degré Nivel	Box Quantity Unité d'emballage Cantidad de cajas
125/150 C/EFSP	35443 4	150	60	15	900	9	1
Eyelet 125/150	09427 9				154		1



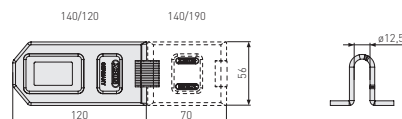

### TECHNOLOGY AND FEATURES



- Hasp and hinge pins made of stainless steel
- Tough construction
- Hinge pins protected against attack
- Hardened staple
- Ideal in combination with Diskus® padlocks
- Hidden screws

### CARACTÉRISTIQUES TECHNIQUES

- Porte cadenas et chevilles en acier cémenté
- Construction robuste
- Articulations protégées contre l'arrachement
- Oeillet en acier cémenté
- Idéal en combinaison avec les cadenas Diskus®
- Vis masquées

### CARACTERÍSTICAS TÉCNICAS

- Portacandados y eje de bisagra de acero inoxidable
- Construcción robusta
- Articulaciones protegidas contra ataques vandálicos
- Argolla endurecida
- Ideal para usar con candado, preferiblemente Diskus®
- Tornillos escondidos

Ref. No. Référence Referencia	EAN 4003318	 mm	 mm	 mm	Weight g Poids g Peso g	Level Degré Nivel	Box Quantity Unité d'emballage Cantidad de cajas
140/120	05312 2	120	56	12,5	355	8	6
140/190	05315 3	190	56	12,5	463	8	6
140/120 B/EFSP	32176 4	120	56	12,5	355	8	6
140/190 B/EFSP	32177 1	190	56	12,5	463	8	3
Eyelet 140/120 + 140/190	09429 3				76		1

## HINGED HASP

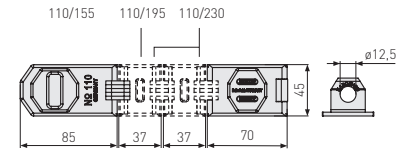

### TECHNOLOGY AND FEATURES

- Tough steel construction
- Hinge pins protected against attack
- Hardened staple
- Hidden screws

### CARACTÉRISTIQUES TECHNIQUES

- Construction robuste en acier
- Articulations à chevilles protégées contre l'arrachement
- Oeillet en acier cémenté
- Vis de fixation cachées

### CARACTERÍSTICAS TÉCNICAS

- Fabricación de acero endurecido
- Eje de articulación protegido contra el arranque
- Argolla endurecida
- Tornillos de fijación ocultos

Ref. No. Référence Referencia	EAN 4003318	 mm	 mm	 mm	Weight g Poids g Peso g	Level Degré Nivel	Box Quantity Unité d'emballage Cantidad de cajas
110/155	01475 8	155	45	12,2	277	8	6
110/195	01479 6	195	45	12,2	340	8	6
110/230	01483 3	230	45	12,2	413	8	6
110/155 B/EFSP	32172 6	155	45	12,2	277	8	3
110/195 C/EFSP	32173 3	195	45	12,2	340	8	3
110/230 C/EFSP	33712 3	230	45	12,2	413	8	3
Eyelet 110/155+195+230	09426 2				62		1

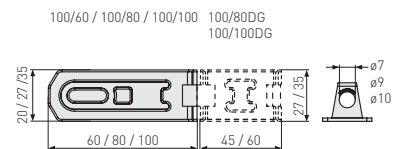
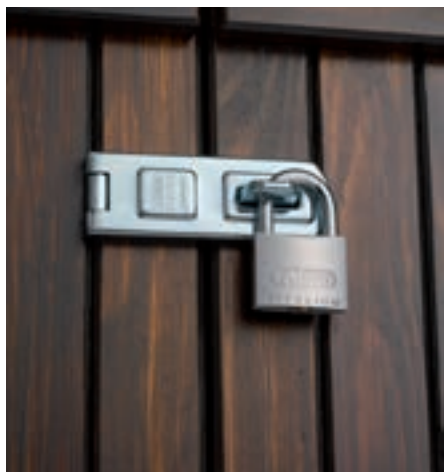

100/80 DG



### TECHNOLOGY AND FEATURES

- Corrosion protected
- As of size 80 hardened staple
- Concealed hinge pin
- Hidden screws

### CARACTÉRISTIQUES TECHNIQUES

- Anti-corrosion
- A partir de taille 80, œillets en acier trempé
- Gonds protégés contre l'extraction
- Vis masquées

### CARACTERÍSTICAS TÉCNICAS

- Tratado contra la corrosión
- Argolla endurecida a partir del tamaño 80mm
- Eje de articulación protegido contra el arranque
- Tornillos de fijación ocultos

Ref. No. Référence Referencia	EAN 4003318	mm	mm	mm	Weight g Poids g Peso g	Level Degré Nivel	Box Quantity Unité d'emballage Cantidad de cajas
100/60	01434 5	60	20	7	19	4	12
100/80	01438 3	80	27	9	63	4	12
100/100	01448 2	100	35	10	128	4	6
100/80 DG	01443 7	125	27	9	89	4	6
100/100 DG	01453 6	160	35	10	188	4	6
100/60 B/EFSP	33704 8	60	20	7	16	4	12
100/80 B/EFSP	33706 2	80	27	9	63	4	6
100/100 B/EFSP	33700 0	100	35	10	128	4	6
100/80 DG B/EFSP	32157 3	125	27	9	89	4	6
100/100 DG B/EFSP	32156 6	160	35	10	188	4	6
Eyelet 100/60	09423 1				2		1
Eyelet 100/80	09424 8				17		1
Eyelet 100/100	09425 5				33		1

## STANDARD HASP

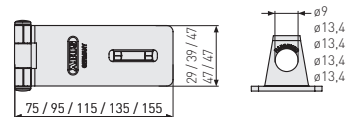
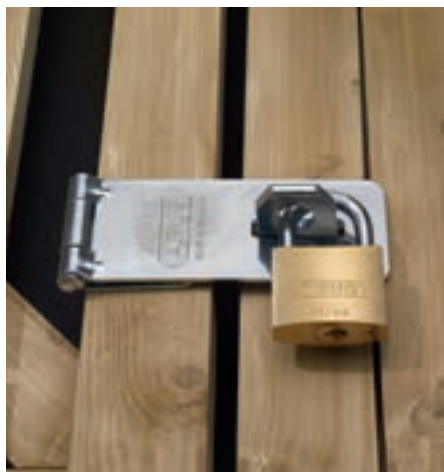

### TECHNOLOGY AND FEATURES



- Corrosion protected
- Steel construction
- Hidden screws

### CARACTÉRISTIQUES TECHNIQUES

- Anti-corrosion
- Oeilllets en acier trempé
- Vis masquées

### CARACTERÍSTICAS TÉCNICAS

- Protegidos contra la corrosión
- Argolla de acero endurecido
- Tornillos escondidos

Ref. No. Référence Referencia	EAN 4003318	 mm	 mm	 mm	Weight g Poids g Peso g	Level Degré Nivel	Box Quantity Unité d'emballage Cantidad de cajas
200/75	01607 3	75	29	9	60	2	12
200/95	01613 4	95	39	13,4	121	2	12
200/115	01619 6	115	47	13,4	176	2	12
200/135	01625 7	135	47	13,4	199	2	6
200/155	01629 5	155	47	13,4	323	2	6
200/75 B/EFSP	35028 3	75	29	9	60	2	6
200/95 B/EFSP	35029 0	95	39	13,4	121	2	6
200/115 B/EFSP	35025 2	115	47	13,4	176	2	6
200/135 B/EFSP	35026 9	135	47	13,4	199	2	6
200/155 B/EFSP	35027 6	155	47	13,4	323	2	6

## LOCKING BRACKET

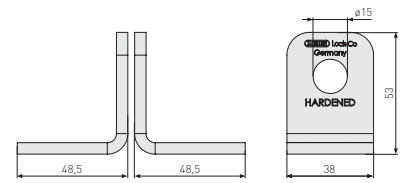

### TECHNOLOGY AND FEATURES

- Corrosion protected
- Made of 5 mm hardened steel
- Install with cup head square neck bolts according to DIN 603 (carriage bolts)



### CARACTÉRISTIQUES TECHNIQUES

- Anti-corrosion
- En acier cémenté, épaisseur 5 mm
- Montage avec boulons à tête bombée avec plot carré selon DIN 603 (boulons de chaînes)"

### CARACTERÍSTICAS TÉCNICAS

- Tratado contra la corrosión
- Escuadra de acero reforzado, 5 mm de grosor
- Montaje con tornillos de cabeza redonda y cuello cuadrado según DIN 603 („tornillo carrocer")



Ref. No. Référence Referencia	EAN 4003318	 mm	 mm	 mm	Weight g Poids g Peso g	Level Degré Nivel	Box Quantity Unité d'emballage Cantidad de cajas
115/100 (Double Pack)	09676 1	100	45	14	258	6	6
115/100 B/EFSP	54117 9	100	45	14	258	6	6

# 300

## HASP

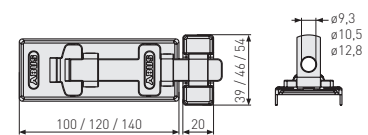

### TECHNOLOGY AND FEATURES

- Corrosion protected
- Hardened bolt
- Hidden screws



### CARACTÉRISTIQUES TECHNIQUES

- Anti-corrosion grâce au chromage au zinc
- Pêne renforcé
- Vis cachées

### CARACTERÍSTICAS TÉCNICAS

- Tratado contra la corrosión
- Pestillo deslizante endurecido
- Tornillos escondidos



Ref. No. Référence Referencia	EAN 4003318	 mm	 mm	 mm	Weight g Poids g Peso g	Level Degré Nivel	Box Quantity Unité d'emballage Cantidad de cajas
300/100 B/EFSP	33690 4	100	39	9,3	180	6	6
300/120 B/EFSP	33691 1	120	46	10,5	250	6	6

# 131 GATESEC

## MORE SECURITY FOR GATES OR FENCES

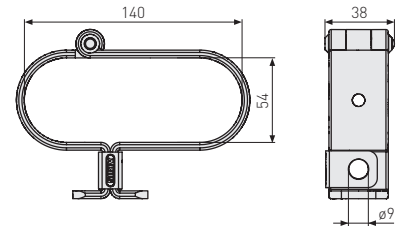

### TECHNOLOGY AND FEATURES

- Solid, hardened steel with rolled-off edges for enormously high cutting resistance
- Eterna™ coating for extreme corrosion resistance
- Special eyelet shape to protect the shackle from the most common attack methods
- Can be mounted on both sides



### CARACTÉRISTIQUES TECHNIQUES

- Construction solide en acier cémenté avec rebords arrondis pour une très grande résistance à la coupure
- Revêtement Eterna™ pour une résistance extrême à la corrosion
- Forme d'anneau spéciale pour la protection de l'anse contre les méthodes d'attaque les plus courantes
- Peut être monté des deux côtés

### CARACTERÍSTICAS TÉCNICAS

- Construcción en acero endurecido con cantos redondeados para una gran resistencia al corte
- Revestimiento Eterna™ para una protección anticorrosión extrema
- Forma especial del ojal para proteger el arco de los métodos de ataque más habituales
- Se puede montar a ambos lados



Ref. No. Référence Referencia	EAN 4003318	 mm	 mm	 mm	Weight g Poids g Peso g	Level Degré Nivel	Box Quantity Unité d'emballage Cantidad de cajas
131/140	76824 8	150	110	10	761	8	1
131/140 B/EFSP	86268 7	150	110	10		8	1

# 138 GATESEC

## ROLLER SHUTTER LOCK

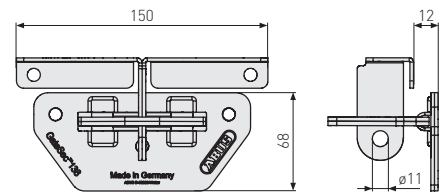
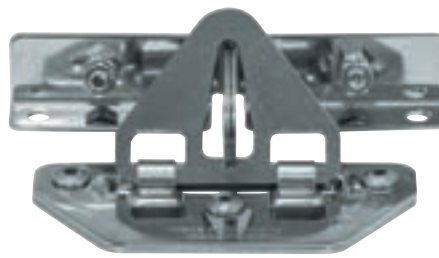

### TECHNOLOGY AND FEATURES

- Solid stainless steel, rust-free
- Tensile resistance above 2.2 tons
- Extremely flat surface mounting with 3 fixing points
- Incl. mounting material
- To be used with a padlock



### CARACTÉRISTIQUES TECHNIQUES

- Acier INOX très résistant
- Plus de 2,2 tonnes de résistance à la traction.
- Porte-cadenas très plat, optimal pour un montage au sol à l'aide de 3 points de fixation.
- Matériel de fixation inclus.
- Utilisation avec un cadenas

### CARACTERÍSTICAS TÉCNICAS

- Acero inoxidable robusto
- Resistencia de tracción de más de 2,2 toneladas
- Montaje en el suelo extremadamente plano con 3 puntos de fijación
- Incl. material de montaje
- Para el uso con un candado



Ref. No. Référence Referencia	EAN 4003318	 mm	 mm	 mm	Weight g Poids g Peso g	Level Degré Nivel	Box Quantity Unité d'emballage Cantidad de cajas
138/150	80901 9	150	68	11	988	8	1
138/150 B/EFSP	87633 2	150	68	11	988	8	1

# WALL AND FLOOR ANCHORS



# GRANIT™ WBA100

## WALL AND FLOOR ANCHOR



### TECHNOLOGY AND FEATURES

- 16 mm thick shackle made of hardened special steel for maximum resistance
- Incl. mounting accessories

### CARACTÉRISTIQUES TECHNIQUES

- Oeillet en acier spécial cémenté de 16 mm de diamètre extrêmement résistant
- Accessoires de montage inclus

### CARACTERÍSTICAS TÉCNICAS

- Arco de 16 mm fabricado en acero especial endurecido para la más alta resistencia
- Accesorios de montaje incluidos



Ref. No. Référence Referencia	EAN 4003318	mm	mm	mm	mm	mm	Weight g Poids g Peso g	Level Degré Nivel	Box Quantity Unité d'emballage Cantidad de cajas
WBA100 GRANIT	27161 8	160	165	16	65	77	1880	20	1

# GRANIT™ WBA75

## WALL AND FLOOR ANCHOR



### TECHNOLOGY AND FEATURES

- 14 mm thick shackle made of hardened special steel for maximum resistance
- Incl. mounting accessories

### CARACTÉRISTIQUES TECHNIQUES

- Oeillet en acier spécial cémenté de 14 mm de diamètre, extrêmement résistant
- Accessoires de montage inclus

### CARACTERÍSTICAS TÉCNICAS

- Arco de 14 mm fabricado en acero especial endurecido para la más alta Resistencia
- Accesorios de montaje incluidos



Ref. No. Référence Referencia	EAN 4003318	mm	mm	mm	mm	mm	Weight g Poids g Peso g	Level Degré Nivel	Box Quantity Unité d'emballage Cantidad de cajas
WBA 75 GRANIT B/SB	78606 8	135	98	14	65	66	850	15	1



# WBA60

## WALL AND FLOOR ANCHOR



### TECHNOLOGY AND FEATURES

- 10 mm thick shackle made of hardened special steel for maximum resistance
- Incl. mounting accessories

### CARACTÉRISTIQUES TECHNIQUES

- Oeillet en acier spécial cémenté de 10 mm de diamètre, extrêmement résistant
- Accessoires de montage inclus

### CARACTERÍSTICAS TÉCNICAS

- Arco de 10 mm fabricado en acero especial endurecido para la más alta Resistencia
- Accesorios de montaje incluidos
- Montaje sencillo



Ref. No.  
Référence  
Referencia

EAN  
4003318



mm



mm



mm



mm



mm

Weight g  
Poids g  
Peso g

Level  
Degré  
Nivel

Box Quantity  
Unité d'emballage  
Cantidad de cajas

WBA 60 B/SB

82211 7

118

80

10

52

55

450

10

1

# WA50

## WALL AND FLOOR ANCHOR



### TECHNOLOGY AND FEATURES

- Strong wall anchor made of hardened steel
- Incl. mounting material

### CARACTÉRISTIQUES TECHNIQUES

- Ancre murale solide faite en acier special cémenté
- Accessoires de montage inclus

### CARACTERÍSTICAS TÉCNICAS

- Fuerte argolla de pared fabricada en acero especial endurecido
- Accesorios de montaje incluidos

Ref. No.  
Référence  
Referencia

EAN  
4003318



mm



mm



mm



mm

Weight g  
Poids g  
Peso g

Level  
Degré  
Nivel

Box Quantity  
Unité d'emballage  
Cantidad de cajas

WA 50

042942

110

80

38

38

786

1



WCH + ACH 9KS/110  
Twin Chain

WCH + ACH 9KS/130

### TECHNOLOGY AND FEATURES

- Wall anchor with integrated chain
- Chain and housing made of proprietary, specially hardened steel alloys
- The wall anchor is firmly anchored in the wall with high-security special wall plugs
- Supplied with highest quality, high security Fischer™ fitting hardware
- Only designed for wall installation
- Chain and housing made of proprietary, specially hardened steel alloys
- Textile sleeve to protect bicycle finish
- Chains available in different lengths and can be swapped
- Daisy-chain multiple Wall chains
- ABUS XPlus cylinder for exceptional protection against manipulation

### CARACTÉRISTIQUES TECHNIQUES

- Ancre murale avec chaîne intégrée
- Chaîne et boîtier en alliage d'acier spécial cimenté
- L'ancrage mural est fermement ancré dans le mur avec des chevilles spéciales de haute sécurité et offre ainsi une protection contre le vol extrêmement élevée
- Fourni avec du matériel de montage Fischer™ de haute qualité et de haute sécurité
- Uniquement conçu pour une installation au mur.
- Chaîne et boîtier en alliage d'acier spécial cimenté
- Gaine textile pour une protection de la peinture du vélo
- Chaînes disponibles en différentes longueurs et peuvent être échangées
- Plusieurs ancrages muraux peuvent être reliés ensemble
- Cylindre ABUS Xplus pour une haute protection contre le crochetage

### CARACTERÍSTICAS TÉCNICAS

- Cadena y carcasa de aleaciones de acero propias y especialmente endurecidas
- El anclaje de pared está firmemente anclado en la pared con tacos especiales de alta seguridad, por lo que ofrece una protección antirrobo extremadamente alta
- Se suministra con herrajes de montaje Fischer™ de alta calidad y seguridad
- Diseñado únicamente para su instalación en la pared
- Cadena y carcasa de aleaciones de acero propias y especialmente endurecidas
- Funda textil para proteger el acabado de la bicicleta
- Cadenas disponibles en diferentes longitudes y que se pueden intercambiar
- Se pueden encadenar varias cadenas de pared
- Cilindro ABUS XPlus para una protección excepcional contra la manipulación

Ref. No. Référence Referencia	EAN 4003318	Diameter Diamètre Diámetro	Length Longueur Longitud	Weight g Poids g Peso g	Level Degré Nivel	Box Quantity Unité d'emballage Cantidad de cajas
WCH + ACH 9KS/110	69061 7	9	110	866	15	1
WCH + ACH 9KS/110 Twin Chain	69063 1	9	110	866	15	1
WCH + ACH 9KS/130	69062 4	9	130	866	15	1



# COMBILoop 205

## SECURITY STEEL CABLE



### TECHNOLOGY AND FEATURES

- 5 mm thick steel cable
- Synthetic coating to prevent damage to the bicycle's paintwork
- Automatic locking at insertion of the locking bolt
- Individually settable code

### CARACTÉRISTIQUES TECHNIQUES

- Câble de 5 mm en acier solide
- Revêtement synthétique pour protéger la peinture du vélo
- Fermeture automatique à l'insertion du boulon de verrouillage
- Programmation individuelle du code

### CARACTERÍSTICAS TÉCNICAS

- Fuerte cable de acero de 5 mm
- Recubrimiento sintético para prevenir daños en la pintura de la bicicleta
- Bloqueo automático en la inserción del perno de fijación
- Código programable individualmente

Ref. No. Référence Referencia	EAN 4003318	 mm	 cm	Weight g Poids g Peso g	Box Quantity Unité d'emballage Cantidad de cajas
205/200 black	52523 0	5	200	180	12

# COMBIFLEX™

## SMALL - COMPACT - FLEXIBLE



2501/65



2502/85



### TECHNOLOGY AND FEATURES



- Automatically rolling up cable
- Individually settable code
- Case in attractive mobile phone format
- 

### CARACTÉRISTIQUES TECHNIQUES

- Câble à enroulement automatique
- Programmation individuelle du code
- Boîtier format de poche

### CARACTERÍSTICAS TÉCNICAS

- Cable de enrollado automático
- Código programable individualmente
- Cabe perfectamente en los bolsillos del maillot

Ref. No. Référence Referencia	EAN 4003318	 mm	 cm	Weight g Poids g Peso g	Box Quantity Unité d'emballage Cantidad de cajas
2501/65	72499 2	1,6	65	54	3
2502/85	72500 5	2	85	80	3
2503/120	72501 2	2,5	120	89	3
2503/120 +UCH 2503	66310 9	2,5	120	100	1



#### TECHNOLOGY AND FEATURES



- High quality steel cable with two loop ends
- Synthetic coating to prevent damage to the bicycle's paintwork

#### CARACTÉRISTIQUES TECHNIQUES

- Câble en acier de haute qualité, terminé par deux boucles de chaque côté
- Revêtement synthétique pour protéger contre tout incidents

#### CARACTERÍSTICAS TÉCNICAS

- Cable de acero de alta calidad con dos terminales tipo lazo
- Recubrimiento sintético para prevenir daños en la pintura de la bicicleta

Ref. No. Référence Referencia	EAN 4003318	 mm	 cm	Weight g Poids g Peso g	Box Quantity Unité d'emballage Cantidad de cajas
Cobra 5/75 black	37106 6	5	75	75	24
Cobra 8/200 black	25718 6	8	200	280	24
Cobra 8/250 black	27390 2	8	250	395	16
Cobra 10/140 black	37107 3	10	140	310	30
Cobra 10/200 black	11167 9	10	200	400	28
Cobra 10/220 black	37108 0	10	220	420	24
Cobra 10/300 black	59930 9	10	300	560	21
Cobra 10/500 black	20780 8	10	500	850	15
Cobra 10/1000 black	20781 5	10	1000	1580	9
Cobra 12/120 black	25719 3	12	120	380	15
Cobra 12/180 black	27391 9	12	180	490	15

## 1850

### FLEXIBLE STEEL CABLE



#### TECHNOLOGY AND FEATURES

- High quality steel cable with two loop ends
- Synthetic coating to prevent damage to the bicycle's paintwork

#### CARACTÉRISTIQUES TECHNIQUES

- Câble en acier de haute qualité, terminé par deux boucles de chaque côté
- Revêtement synthétique pour protéger contre tout incidents

#### CARACTERÍSTICAS TÉCNICAS

- Cable de acero de alta calidad con dos terminales tipo lazo
- Recubrimiento sintético para prevenir daños en la pintura de la bicicleta
- Este producto está disponible en diferentes diámetros y longitudes

Ref. No. Référence Referencia	EAN 4003318	 mm	 cm	Weight g Poids g Peso g	Box Quantity Unité d'emballage Cantidad de cajas
1850/185	12752 6	8	185	280	18

# 6KS

## CHAIN



### TECHNOLOGY AND FEATURES

- Security chain made of special hardened steel
- Top security against all types of aggressive attacks
- Fabric sleeve prevents paint work and chrome from damage
- Chains in barrels: customized lengths available

### CARACTÉRISTIQUES TECHNIQUES

- Chaînes en acier cémenté
- Haute protection contre toutes sortes d'attaques brutales
- Gainage textile pour la protection du vernis et du chrome contre des rayures

### CARACTERÍSTICAS TÉCNICAS

- Cadena de seguridad de acero templado especial
- Máxima seguridad contra todo tipo de ataques
- La funda de tela evita daños en la pintura y el cromo
- Cadenas versátiles: longitudes personalizadas disponibles

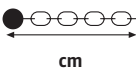
Ref. No. Référence Referencia	EAN 4003318	 mm	 cm	Weight g Poids g Peso g	Box Quantity Unité d'emballage Cantidad de cajas
Chain 6KS65 black	27292 9	6	65	559	6
Chain 6KS85 black	27293 6	6	85	722	6
Chain 6KS110 black	28329 1	6	110	938	6

# 8KS

## CHAIN



### TECHNOLOGY AND FEATURES

- Security chain made of special hardened steel
- Top security against all types of aggressive attacks
- Fabric sleeve prevents paint work and chrome from damage
- Chains in barrels: customized lengths available

### CARACTÉRISTIQUES TECHNIQUES

- Chaînes en acier cémenté
- Haute protection contre toutes sortes d'attaques brutales
- Gainage textile pour la protection du vernis et du chrome contre des rayures

### CARACTERÍSTICAS TÉCNICAS

- Cadena de seguridad de acero templado especial
- Máxima seguridad contra todo tipo de ataques
- La funda de tela evita daños en la pintura y el cromo
- Cadenas versátiles: longitudes personalizadas disponibles

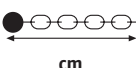
Ref. No. Référence Referencia	EAN 4003318	 mm	 cm	Weight g Poids g Peso g	Box Quantity Unité d'emballage Cantidad de cajas
Chain 8KS85 black	27294 3	8	85	1328	2
Chain 8KS110 black	27295 0	8	110	1725	2
Chain 8KS140 black	28509 7	8	140	2090	2

# 9KS LOOP

## CHAIN



### TECHNOLOGY AND FEATURES

- Chain (9 mm) made of hardened steel
- Fabric sleeve prevents surroundings from damage
- Loop chain comes with a larger loop on one end, making the chain go further

### CARACTÉRISTIQUES TECHNIQUES

- Chaînes (9 mm) en acier cémenté
- Gaine textile pour la protection du vernis et du chrome contre des rayures
- Câble-antivol LOOP à boucles

### CARACTERÍSTICAS TÉCNICAS

- Cadena (9 mm) de acero templado
- La funda textil evita daños en el entorno
- La cadena cuenta con un eslabón más grande en uno de los extremos, lo que hace que la cadena llegue más lejos

Ref. No. Référence Referencia	EAN 4003318	 mm	 cm	Weight g Poids g Peso g	Box Quantity Unité d'emballage Cantidad de cajas
Chain 9KS250 loop	45579 7	9	250	4930	2

# 10KS

## CHAIN



### TECHNOLOGY AND FEATURES

- Security chain made of special hardened steel
- Fabric sleeve prevents paint work and chrome from damage
- Chains in barrels: customized lengths available
- Top security against all types of aggressive attacks

### CARACTÉRISTIQUES TECHNIQUES

- Chaîne en acier cémenté
- Gainage textile pour la protection du vernis et du chrome contre des rayures
- Haute protection contre toutes sortes d'attaques brutales

### CARACTERÍSTICAS TÉCNICAS

- Cadena de acero endurecida
- Con un eslabón de cadena más largo para una fácil inclusión con candado
- La funda de tejido evita que se produzcan daños en la pintura y en el cromo

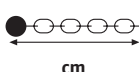
Ref. No. Référence Referencia	EAN 4003318	 mm	 cm	Weight g Poids g Peso g	Box Quantity Unité d'emballage Cantidad de cajas
Chain 10KS110 black	27168 7	10	110	2510	2
Chain 10KS140 black	27167 0	10	140	3110	2
Chain 10KS170 black	27166 3	10	170	3838	2
Chain 10KS200 black	27530 2	10	200	4540	1

# 12KS LOOP

## CHAIN



### TECHNOLOGY AND FEATURES

- High-security chain made of special hardened steel
- Top security against all types of aggressive attacks
- Fabric sleeve prevents paint work and chrome from damage
- Loop version for more fixing options
- Chains in barrels: customized lengths available

### CARACTÉRISTIQUES TECHNIQUES

- Chaînes en acier cémenté
- Haute protection contre toutes sortes d'attaques brutales
- Gainage textile pour la protection du vernis et du chrome contre des rayures

### CARACTERÍSTICAS TÉCNICAS

- Cadena de alta seguridad de acero templado especial
- Máxima seguridad contra todo tipo de ataques
- La funda de tela evita daños en la pintura y el cromo
- Diseño a modo de cadena para más opciones de fijación
- Cadenas versátiles: longitudes personalizadas disponibles

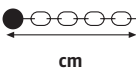
Ref. No. Référence Referencia	EAN 4003318	 mm	 cm	Weight g Poids g Peso g	Box Quantity Unité d'emballage Cantidad de cajas
Chain 12KS80 Loop	30737 9	12	80	2474	1
Chain 12KS120 Loop black	28534 9	12	120	3950	1
Chain 12KS250 Loop black	35485 4	12	250	7500	1



# LOCKOUT / TAGOUT



# PROTECT THE LIVES OF YOUR EMPLOYEES

## ENSURE A SAFE WORKING ENVIRONMENT!

With a complete lockout/tagout system, you can ensure that your employees are able to perform maintenance work without worrying about their safety or fearing for their lives. This provides added security, which not only helps to prevent accidents caused by the unexpected start-up of machinery and equipment, but also encourages employees to deal with hazards consciously and safely and optimises internal processes.

In addition to a targeted lockout/tagout configuration, the choice of suitable locking systems and devices determines the level of safety for your employees. ABUS offers an extensive range of suitable padlocks and locking devices which meet lockout/tagout requirements, giving you and your employees the good feeling of security.



## ALUMINUM PADLOCK FOR PROTECTION AND SAFETY AT THE WORKPLACE



76/40



76BS/40



76IB/40



76PS/40



Product Video



## TECHNOLOGY AND FEATURES







- Body and shackle insulated
- Solid aluminum core: Lightweight and durable
- Precision 8-pin cylinder for the very high number of 200,000 guaranteed keyed different bittings
- Large, extremely breaking resistant key with V-shape cuts ensures high precision
- Automatic locking for user convenience
- 9 different shackle options
- One key according to lockout requirement: one worker, one lock, one key
- Key-retaining: Lock retains key until locked

## CARACTÉRISTIQUES TECHNIQUES







- Corps et anse isolés
- Noyau solide en aluminium : léger et durable
- Cylindre de précision à 8 broches pour le nombre très élevé de 200 000 raccords différents garantis par clé
- La clé de grande taille, extrêmement résistante à la rupture, avec des découpes en V, assure une grande précision
- Verrouillage automatique pour le confort de l'utilisateur
- 9 options d'anses différentes
- Une clé selon l'exigence de consignation : un travailleur, une serrure, une clé
- Retenue de la clé : le cadenas retient la clé jusqu'à ce qu'il soit verrouillé

## CARACTERÍSTICAS TÉCNICAS

- Cuerpo y arco aislados
- Núcleo de aluminio macizo: ligero y duradero
- Cilindro de precisión de 8 pernos para el elevadísimo número de 200.000 dentados de llave diferentes
- Llave grande y extremadamente resistente a la rotura con cortes en forma de V que garantiza una gran precisión
- Bloqueo automático para mayor comodidad de uso
- 9 opciones de arco diferentes
- Una llave de acuerdo con el principio de lockout: un trabajador, un candado, una llave
- Retención de llave: el candado retiene la llave hasta que se cierra

Ref. No. Référence Referencia	EAN 4003318	 mm	 mm	 mm	 mm	 mm	 mm	Weight g Poids g Peso g	Key Blank Ébauche Llave en bruto	Level Degré Nivel	Box Quantity Unité d'emballage Cantidad de cajas
76BS/40 red	84781 3	40	20	39	4,76	22	90	125		8	6
76BS/40 yellow	84782 0	40	20	39	4,76	22	90	125		8	6
76BS/40 green	84783 7	40	20	39	4,76	22	90	125		8	6
76BS/40 blue	84784 4	40	20	39	4,76	22	90	125		8	6
76BS/40 orange	84785 1	40	20	39	4,76	22	90	125		8	6
76BS/40 purple	84786 8	40	20	39	4,76	22	90	125		8	6
76BS/40 white	84787 5	40	20	39	4,76	22	90	125		8	6
76BS/40 black	84788 2	40	20	39	4,76	22	90	125		8	6
76BS/40 grey	84789 9	40	20	39	4,76	22	90	125		8	6
76BS/40 brown	84790 5	40	20	39	4,76	22	90	125		8	6
76/40 red	84768 4	41	19	38	6,5	22	91	126		8	6
76/40 yellow	84769 1	41	19	38	6,5	22	91	126		8	6
76/40 green	84770 7	41	19	38	6,5	22	91	126		8	6
76/40 blue	84771 4	41	19	38	6,5	22	91	126		8	6
76/40 orange	84772 1	41	19	38	6,5	22	91	126		8	6
76/40 purple	84773 8	41	19	38	6,5	22	91	126		8	6
76/40 white	84774 5	41	19	38	6,5	22	91	126		8	6
76/40 black	84775 2	41	19	38	6,5	22	91	126		8	6
76/40 grey	84776 9	41	19	38	6,5	22	91	126		8	6
76/40 brown	84777 6	41	19	38	6,5	22	91	126		8	6
76IB/40 red	84794 3	40	20	39	4,76	22	90	124		8	6



Ref. No. Référence Referencia	EAN 4003318	 mm	 mm	 mm	 mm	 mm	 mm	Weight g Poids g Peso g	Key Blank Ébauche Llave en bruto	Level Degré Nivel	Box Quantity Unité d'emballage Cantidad de cajas
76/40CAB40 grey	84885 8	40	flexible	max. 190	4,76	20	max. 242	122		7	6
76/40CAB40 brown	84886 5	40	flexible	max. 190	4,76	20	max. 242	122		7	6

**SURCHARGE / MAJORATION / RECARGO**

- Keyed alike / S'entrouvrant / Llaves iguales
- Keyed alike as per sample / Fermeture selon échantillon / Cierre según muestra
- Master key function / Clé passe / Funcion llave maestra

## LIGHTWEIGHT ALUMINUM PADLOCK FOR SAFETY AT WORK



## TECHNOLOGY AND FEATURES

- Solid aluminum core with steel shackle for best physical strength
- Body and shackle insulated against electric shock
- NANO-PROTECT™ shackle for superior corrosion resistance
- Intrinsically safe, key retaining
- Automatic locking for user convenience
- Compact and lightweight
- High precision 6-pin cylinder for better tamper resistance







## CARACTÉRISTIQUES TECHNIQUES

- Corps solide en aluminium avec anse en acier pour une résistance optimale contre toute sorte d'attaques brutales
- Corps et anse isolés pour protéger contre des décharges électriques
- Anse NANO-PROTECT™ pour résistance excellente à la corrosion
- Fonction clé prisonnière
- Verrouillage automatique pour plus de confort d'utilisation
- Compact et léger
- Cylindre de précision à 6 goupilles - haute résistance anti-manipulation

## CARACTERÍSTICAS TÉCNICAS

- Núcleo de aluminio macizo con arco de acero para una mayor resistencia física
- Cuerpo y arco aislados contra descargas eléctricas
- Arco NANO-PROTECT™ para una mayor resistencia a la corrosión
- Intrínsecamente seguro, con retención de llave
- Bloqueo automático para mayor comodidad de uso
- Compacto y ligero
- Cilindro de 6 pernos de alta precisión para una mayor resistencia a la manipulación

Ref. No. Référence Referencia	EAN 4003318							Weight g Poids g Peso g	Key Blank Ébauche Llave en bruto	Level Degré Nivel	Box Quantity Unité d'emballage Cantidad de cajas
		mm	mm	mm	mm	mm	mm				
74/40 red	59108 2	40	19	38	6,5	20	90	100		6	6
74/40 yellow	59110 5	40	19	38	6,5	20	90	100		6	6
74/40 green	59112 9	40	19	38	6,5	20	90	100		6	6
74/40 blue	59109 9	40	19	38	6,5	20	90	100		6	6
74/40 orange	59113 6	40	19	38	6,5	20	90	100		6	6
74/40 purple	59115 0	40	19	38	6,5	20	90	100		6	6
74/40 white	58978 2	40	19	38	6,5	20	90	100		6	6
74/40 black	59111 2	40	19	38	6,5	20	90	100		6	6
74/40 grey	58979 9	40	19	38	6,5	20	90	100		6	6
74/40 brown	59114 3	40	19	38	6,5	20	90	100		6	6
74BS/40 red	77569 7	40	20	39	4,76	20	89	99		6	6
74BS/40 yellow	77567 3	40	20	39	4,76	20	89	99		6	6
74BS/40 green	77570 3	40	20	39	4,76	20	89	99		6	6
74BS/40 blue	77571 0	40	20	39	4,76	20	89	99		6	6
74BS/40 orange	77572 7	40	20	39	4,76	20	89	99		6	6
74BS/40 purple	77573 4	40	20	39	4,76	20	89	99		6	6
74BS/40 white	77574 1	40	20	39	4,76	20	89	99		6	6
74BS/40 black	77575 8	40	20	39	4,76	20	89	99		6	6
74BS/40 grey	77576 5	40	20	39	4,76	20	89	99		6	6
74BS/40 brown	77577 2	40	20	39	4,76	20	89	99		6	6

Ref. No. Référence Referencia	EAN 4003318							Weight g Poids g Peso g	Key Blank Ébauche Llave en bruto	Level Degré Nivel	Box Quantity Unité d'emballage Cantidad de cajas
		mm	mm	mm	mm	mm	mm				
74/40HB75 red	59116 7	40	19	75	6,5	20	126	110		6	6
74/40HB75 yellow	58031 4	40	19	75	6,5	20	126	110		6	6
74/40HB75 green	58984 3	40	19	75	6,5	20	126	110		6	6
74/40HB75 blue	59117 4	40	19	75	6,5	20	126	110		6	6
74/40HB75 orange	58985 0	40	19	75	6,5	20	126	110		6	6
74/40HB75 purple	58986 7	40	19	75	6,5	20	126	110		6	6
74/40HB75 white	58987 4	40	19	75	6,5	20	126	110		6	6
74/40HB75 black	58980 5	40	19	75	6,5	20	126	110		6	6
74/40HB75 grey	58988 1	40	19	75	6,5	20	126	110		6	6
74/40HB75 brown	58032 1	40	19	75	6,5	20	126	110		6	6
74BS/40HB75 red	79584 8	40	20	76	4,76	20	125	108		6	6
74BS/40HB75 yellow	85581 8	40	20	76	4,76	20	125	108		6	6
74BS/40HB75 green	85582 5	40	20	76	4,76	20	125	108		6	6
74BS/40HB75 blue	82561 3	40	20	76	4,76	20	125	108		6	6
74BS/40HB75 orange	85583 2	40	20	76	4,76	20	125	108		6	6
74BS/40HB75 purple	85584 9	40	20	76	4,76	20	125	108		6	6
74BS/40HB75 white	85585 6	40	20	76	4,76	20	125	108		6	6
74BS/40HB75 black	85586 3	40	20	76	4,76	20	125	108		6	6
74BS/40HB75 grey	85598 6	40	20	76	4,76	20	125	108		6	6
74BS/40HB75 brown	85599 3	40	20	76	4,76	20	125	108		6	6
74LB/40 red	34970 6	40	19	38	6,5	20	120	109		6	6
74LB/40 yellow	50335 1	40	19	38	6,5	20	120	109		6	6
74LB/40 green	50306 1	40	19	38	6,5	20	120	109		6	6
74LB/40 blue	50300 9	40	19	38	6,5	20	120	109		6	6
74LB/40 orange	50332 0	40	19	38	6,5	20	120	107		6	6
74LB/40 purple	50333 7	40	19	38	6,5	20	120	109		6	6
74LB/40 white	50334 4	40	19	38	6,5	20	120	109		6	6
74LB/40 black	50299 6	40	19	38	6,5	20	120	109		6	6
74LB/40 grey	50309 2	40	19	38	6,5	20	120	109		6	6
74LB/40 brown	50305 4	40	19	38	6,5	20	120	109		6	6

#### SURCHARGE / MAJORATION / RECARGO

- Keyed alike / S'entrouvrant / Llaves iguales
- Keyed alike as per sample / Fermeture selon échantillon / Cierre según muestra
- Master key function / Clé passe / Funcion llave maestra

# 72/30 | 72/30CAB

## COMPACT ALUMINUM SAFETY PADLOCK



72/30 green



72/30 red



72/30 black



72/30HB50 yellow



72/30HB50 orange



72/30HB50 purple



72/30HB50 brown



72/30CAB red



### TECHNOLOGY AND FEATURES

- Solid, anodized aluminum body
- Shackle made of steel with Nano Protect plating, also available in stainless steel (IB) or aluminum (AS) or with flexible steel cable (CAB)
- 5-pin precision cylinder
- Cylinder can be rekeyed to match an existing key
- Available keyed alike, master keyed and grand master keyed
- Key-retaining (Lock retains key until locked)

### CARACTÉRISTIQUES TECHNIQUES







- Boîtier massif en aluminium anodisé
- Anse en acier avec technologie Nano Protect, également disponible en version acier INOX (IB), aluminium (AS) ou avec câble en acier flexible (CAB)
- Cylindre à 5 goupilles
- Le cylindre peut être adapté à des fermetures existantes
- Disponible en exécution s'entrouvant et sur organigramme
- Clé-prisonnière (Pour fermer le cadenas, la clé est indispensable)

### CARACTERÍSTICAS TÉCNICAS

- Cuerpo de anodizado aluminio sólido
- Arco de acero de aleación especial protegido con recubrimiento NANO PROTECT™, también disponible con arco de acero inoxidable y de aluminio
- Cilindro de 5 pitones
- Se puede modificarse el sierra para la llave existente
- Retención de llave (La cerradura retiene la llave hasta que se cierre)
- Disponibilidad de llaves iguales y de llave maestra

Ref. No. Référence Referencia	EAN 4003318							Weight g Poids g Peso g	Key Blank Ébauche Llave en bruto	Level Degré Nivel	Box Quantity Unité d'emballage Cantidad de cajas
		mm	mm	mm	mm	mm	mm				
72/30 red	82209 4	32	17	26,5	4,76	16	76	66		5	6
72/30 yellow	82210 0	32	17	26,5	4,76	16	76	66		5	6
72/30 green	82218 6	32	17	26,5	4,76	16	76	66		5	6
72/30 blue	82219 3	32	17	26,5	4,76	16	76	66		5	6
72/30 orange	82220 9	32	17	26,5	4,76	16	76	66		5	6
72/30 purple	82221 6	32	17	26,5	4,76	16	76	66		5	6
72/30 black	82222 3	32	17	26,5	4,76	16	76	66		5	6
72/30 brown	82223 0	32	17	26,5	4,76	16	76	66		5	6
72/30HB50 red	87445 1	32	17	51	4,76	16	89	69		5	6
72/30HB50 yellow	87447 5	32	17	51	4,76	16	89	69		5	6
72/30HB50 green	87448 2	32	17	51	4,76	16	89	69		5	6
72/30HB50 blue	87446 8	32	17	51	4,76	16	89	69		5	6
72/30HB50 orange	87449 9	32	17	51	4,76	16	89	69		5	6
72/30HB50 purple	87450 5	32	17	51	4,76	16	89	69		5	6
72/30HB50 black	87451 2	32	17	51	4,76	16	89	69		5	6
72/30HB50 brown	87452 9	32	17	51	4,76	16	89	69		5	6
72AS/30HB38 red	87453 6	32	17	39	4,76	16	78	55		5	6
72AS/30HB38 yellow	87455 0	32	17	39	4,76	16	78	55		5	6
72AS/30HB38 green	87456 7	32	17	39	4,76	16	78	55		5	6
72AS/30HB38 blue	87454 3	32	17	39	4,76	16	78	55		5	6
72AS/30HB38 orange	87457 4	32	17	39	4,76	16	78	55		5	6



Ref. No. Référence Referencia	EAN 4003318							Weight g Poids g Peso g	Key Blank Ébauche Llave en bruto	Level Degré Nivel	Box Quantity Unité d'emballage Cantidad de cajas
		mm	mm	mm	mm	mm	mm				
72AS/30HB38 purple	87458 1	32	17	39	4,76	16	78	55		5	6
72AS/30HB38 black	87459 8	32	17	39	4,76	16	78	55		5	6
72AS/30HB38 brown	87460 4	32	17	39	4,76	16	78	55		5	6
72IB/30 red	87461 1	32	17	26,5	4,76	16	65	66		5	6
72IB/30 yellow	87463 5	32	17	26,5	4,76	16	65	66		5	6
72IB/30 green	87464 2	32	17	26,5	4,76	16	65	66		5	6
72IB/30 blue	87462 8	32	17	26,5	4,76	16	65	66		5	6
72IB/30 orange	87465 9	32	17	26,5	4,76	16	65	66		5	6
72IB/30 purple	87466 6	32	17	26,5	4,76	16	65	66		5	6
72IB/30 black	87467 3	32	17	26,5	4,76	16	65	66		5	6
72IB/30 brown	87468 0	32	17	26,5	4,76	16	65	66		5	6
72IB/30HB50 red	87469 7	32	17	51	4,76	16	89	69		5	6
72IB/30HB50 yellow	87471 0	32	17	51	4,76	16	89	69		5	6
72IB/30HB50 green	87472 7	32	17	51	4,76	16	89	69		5	6
72IB/30HB50 blue	87470 3	32	17	51	4,76	16	89	69		5	6
72IB/30HB50 orange	87473 4	32	17	51	4,76	16	89	69		5	6
72IB/30HB50 purple	87474 1	32	17	51	4,76	16	89	69		5	6
72IB/30HB50 black	87475 8	32	17	51	4,76	16	89	69		5	6
72IB/30HB50 brown	87476 5	32	17	51	4,76	16	89	69		5	6
72/30CAB20 red	87477 2	32	flexible	max. 100	4,76	16	max. 130	78		4	6
72/30CAB20 yellow	87483 3	32	flexible	max. 100	4,76	16	max. 130	78		4	6
72/30CAB20 green	87479 6	32	flexible	max. 100	4,76	16	max. 130	78		4	6
72/30CAB20 blue	87478 9	32	flexible	max. 100	4,76	16	max. 130	78		4	6
72/30CAB20 orange	87480 2	32	flexible	max. 100	4,76	16	max. 130	78		4	6
72/30CAB20 purple	87481 9	32	flexible	max. 100	4,76	16	max. 130	78		4	6
72/30CAB20 black	87482 6	32	flexible	max. 100	4,76	16	max. 130	78		4	6
72/30CAB20 brown	87484 0	32	flexible	max. 100	4,76	16	max. 130	78		4	6
72/30CAB40 red	87485 7	32	flexible	max. 180	5	16	max. 230	82		4	6
72/30CAB40 yellow	87487 1	32	flexible	max. 180	5	16	max. 230	82		4	6
72/30CAB40 green	87488 8	32	flexible	max. 180	5	16	max. 230	82		4	6
72/30CAB40 blue	87486 4	32	flexible	max. 180	5	16	max. 230	82		4	6
72/30CAB40 orange	87489 5	32	flexible	max. 180	5	16	max. 230	82		4	6
72/30CAB40 purple	87490 1	32	flexible	max. 180	5	16	max. 230	82		4	6
72/30CAB40 black	87491 8	32	flexible	max. 180	5	16	max. 230	82		4	6
72/30CAB40 brown	87492 5	32	flexible	max. 180	5	16	max. 230	82		4	6

#### SURCHARGE / MAJORATION / RECARGO

- Keyed alike / S'entrouvrant / Llaves iguales
- Keyed alike as per sample / Fermeture selon échantillon / Cierre según muestra
- Master key function / Clé passe / Funcion llave maestra

# E201 | E211 | E212

## LOCKOUT OF SINGLE CIRCUIT BREAKERS



E211



E212



Product Video

### TECHNOLOGY AND FEATURES

- High-quality materials: long-lasting, robust and non-conductive
- Easy-to-use with screwing mechanism for secure fixation
- Can be used universally on common single-pole circuit breakers
- With adapter for blade-type electric fuses

### CARACTÉRISTIQUES TECHNIQUES

- Matériaux de haute qualité: durables, résistants, non conducteurs
- Facile à utiliser, avec mécanisme à vis pour une fixation sûre
- Universellement applicable aux disjoncteurs unipolaires standard
- Avec adaptateur pour fusibles plats

### CARACTERÍSTICAS TÉCNICAS

- Materiales de alta calidad: duradero, resistente, no conductor
- Fácil aplicación con mecanismo atornillable para una fijación segura
- Uso universal en fusibles estándar de un solo polo
- Con adaptador para fusibles planos

Ref. No. Référence Referencia	EAN 4003318	Locking Points Points de fermetures Puntos de bloqueo	Shackle Diameter mm Diamètre d'anse mm Diámetro del grillete mm	Length mm Longueur mm Larga mm	Width mm Largeur mm Ancho mm	Depth mm Profondeur mm Profundidad mm	Box Quantity Unité d'emballage Cantidad de cajas
E201	00368 4	1	7	55	29	41	1
E211	64295 1	1	7	76	59	52	1
E212	64297 5	1	7	96	92	68	1

Max. width of circuit breaker: 16 mm  
 Largeur maximale du fusible: 16 mm  
 Máx. ancho del disyuntor: 16 mm

# E203

## UNIVERSAL CIRCUIT BREAKER LOCKOUT



### TECHNOLOGY AND FEATURES

- High-quality materials: long-lasting, robust and non-conductive
- Easy-to-use with screwing mechanism for secure fixation
- For Padlocks up to 6.5 mm shackle diameter or wires/cable locks up to 5 mm

### CARACTÉRISTIQUES TECHNIQUES

- Matériaux haut de gamme : durables, résistants, non conducteurs
- Utilisation simple avec mécanisme à vis pour une fixation sûre
- Pour les cadenas avec un diamètre d'anse jusqu'à 6,5 mm ou les câbles/cadenas à câble jusqu'à 5 mm

### CARACTERÍSTICAS TÉCNICAS

- Materiales de alta calidad, duraderos, resistentes, no conductores
- Uso sencillo con mecanismo atornillable para una fijación segura (sin herramientas)
- Se puede utilizar de forma universal en disyuntores convencionales

Ref. No. Référence Referencia	EAN 4003318	Locking Points Points de fermetures Puntos de bloqueo	Shackle Diameter mm Diamètre d'anse mm Diámetro del grillete mm	Length mm Longueur mm Larga mm	Width mm Largeur mm Ancho mm	Depth mm Profondeur mm Profundidad mm	Box Quantity Unité d'emballage Cantidad de cajas
E203	77795 0	1	6,5	53	17	35	1

# E218- 233

## LOCKOUT DEVICES FOR SCREW-IN FUSES



E233

### TECHNOLOGY AND FEATURES

- With hole to insert a padlock with up to 6.5 mm shackle diameter
- Yellow special key included to apply and remove the device, can be stored at the padlock shackle as needed
- Swiveling padlock hole allows you to attach an appropriate lock with flexible cable in order to secure several bottle fuses in a row

### CARACTÉRISTIQUES TECHNIQUES

- Avec support pour cadenas avec un diamètre d'anse jusqu'à 6,5 mm
- Clé spéciale jaune pour poser et retirer le verrouillage, peut se ranger si nécessaire sur l'anse du cadenas
- Possible d'accrocher plusieurs verrouillage côte à côte et de les relier avec un seul cadenas à câble

### CARACTERÍSTICAS TÉCNICAS

- Con diámetro de rosca graduado para roscas E14 y E18
- Se adjunta una llave especial amarilla para ajustar y retirar el dispositivo de bloqueo
- Se pueden asegurar en serie varias bases roscadas gracias al alojamiento flexible con la ayuda de un cable o un candado de cable

Ref. No. Référence Referencia	EAN 4003318	Locking Points Points de fermetures Puntos de bloqueo	Shackle Diameter mm Diamètre d'anse mm Diámetro del grillete mm	Length mm Longueur mm Larga mm	Width mm Largeur mm Ancho mm	Depth mm Profondeur mm Profundidad mm	Box Quantity Unité d'emballage Cantidad de cajas
E218	83677 0	1	7	25	52	25	1
E233	83680 0	1	7	40	61	40	1

## PROTECTION SWITCH LOCKOUT DEVICES



### TECHNOLOGY AND FEATURES

- The E245 is positioned on the motor protection switch, tightly clamped by means of the locking mechanism and secured with a padlock
- For all motor protection switches with a switch panel height of 45 mm

### CARACTÉRISTIQUES TECHNIQUES

- Le E245 est placé sur le disjoncteur moteur, bloqué avec un mécanisme de verrouillage et sécurisé à l'aide d'un cadenas
- Pour tous les disjoncteurs moteurs avec une paroi d'interrupteur de 45 mm de hauteur

### CARACTERÍSTICAS TÉCNICAS

- El E245 se coloca en el disyuntor para motor, se fija mediante un mecanismo de cierre y se asegura con un candado
- Para todos los disyuntores para motor con una altura frontal de 45 mm

Ref. No. Référence Referencia	EAN 4003318	Length mm Longueur mm Larga mm	Width mm Largeur mm Ancho mm	Depth mm Profondeur mm Profundidad mm	Box Quantity Unité d'emballage Cantidad de cajas
E245	89481 7	57	45	44	1

# V303-313

## VALVE LOCKOUT



V305



V307



V310



V313



Product Video

### TECHNOLOGY AND FEATURES

- High-quality polypropylene: long-lasting, robust and non-conductive
- Five sizes: Valves from 1" to 13"
- Holds 1 padlock with up to 9 mm shackle diameter
- Unique, predetermined breaking point at the top for valves with thread
- Stickers in various languages included

### CARACTÉRISTIQUES TECHNIQUES

- Polypropylène de haute qualité: durable, résistant, non conducteur
- Cinq tailles: volants de vanne de 1" à 13"
- Pour chaînes présentant une anse jusqu'à 9 mm de diamètre
- Point d'encoche unique pour les volants avec broche
- Étiquettes d'avertissement auto-adhésives en différentes langues

### CARACTERÍSTICAS TÉCNICAS

- Polipropileno de alta calidad: duradero, resistente, no conductor
- Cinco tamaños: válvulas rotativas manuales de 25 mm hasta 330 mm
- Para un candado con arco de un diámetro de hasta 9 mm
- Punto de entalladura único para válvulas rotativas manuales con husillo
- Señales de advertencia autoadhesivas en diferentes idiomas

Ref. No. Référence Referencia	EAN 4003318	Locking Points Points de fermetures Puntos de bloqueo	Shackle Diameter Diamètre d'anse Diámetro del grillete mm	Length Longueur Larga mm	Width Largeur Ancho mm	Depth Profondeur Profundidad mm	Inside Height Hauteur intérieure Altura interior mm	Inner Diameter Diamètre intérieur- Diámetro interno mm	Box Quantity Unité d'emballage Cantidad de cajas
V303	00362 2	1	9	121	80	36	22	70	1
V305	00364 6	1	9	185	142	51	31	130	1
V307	00365 3	1	9	225	181	61	42	170	1
V310	00366 0	1	9	319	277	77	55	267	1
V313	00367 7	1	9	406	364	77	53	350	1

# V423- 426

## BALL VALVE LOCKOUT

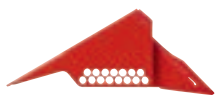

V426

Product Video

### TECHNOLOGY AND FEATURES

- Stable and secure, made from powder-coated steel
- Two sizes for most common ball valves
- A number of holes for exact positioning of the padlock gives more stability
- Best used on hard-to-reach pipes

### CARACTÉRISTIQUES TECHNIQUES

- Acier peint par poudrage, stable et sûr
- Deux tailles, pour presque toutes les vannes à boisseau sphérique
- Nombreux trous pour positionner avec précision le cadenas, pour plus de stabilité
- Particulièrement adapté aux conduits difficilement accessibles

### CARACTERÍSTICAS TÉCNICAS

- De acero con recubrimiento de polvo, estable y seguro
- Dos tamaños para casi todas las válvulas de bola
- Muchos agujeros para posicionar con precisión el candado y lograr una mayor estabilidad
- Especialmente adecuado para tuberías de difícil acceso

Ref. No. Référence Referencia	EAN 4003318	Locking Points Points de fermetures Puntos de bloqueo	Shackle Diameter Diamètre d'anse Diámetro del grillete mm	Length Longueur Larga mm	Width Largeur Ancho mm	Depth Profondeur Profundidad mm	Max. Handle Thickness Epaisseur maximale de la poignée Espesor máximo del mango mm	Max. Handle Width Largeur maximale de la poignée Ancho máximo del mango mm	Box Quantity Unité d'emballage Cantidad de cajas
V423	00299 1	1	7	90	52	63	7	37	9
V426	00300 4	1	7	140	125	122	10	50	6

# V442-448

## BALL VALVE LOCKOUT



V448

Product Video

### TECHNOLOGY AND FEATURES

- High-quality polypropylene; long-lasting, robust and non-conductive
- Two sizes: Handles for ball valves from 1/2" to 8"
- Well-positioned padlock holes for better grip on the valve

### CARACTÉRISTIQUES TECHNIQUES

- Polypropylène de haute qualité: durable, résistant, non conducteur
- Deux tailles: poignées pour vanne à boisseau sphérique de 1/2" à 8"
- Trous précis pour cadenas, pour un ajustement parfait autour de la vanne

### CARACTERÍSTICAS TÉCNICAS

- Polipropileno de alta calidad: duradero, resistente, no conductor
- Dos tamaños: mangos para válvulas de bola de 1/2" a 8"
- Agujeros de ajuste fino para candados con el fin de lograr un cierre hermético de la válvula

Ref. No. Référence Referencia	EAN 4003318	Locking Points Points de fermetures Puntos de bloqueo	Shackle Diameter Diamètre d'anse Diámetro del grillete mm	Length Longueur Larga mm	Width Largeur Ancho mm	Depth Profondeur Profundidad mm	Max. Handle Thickness Epaisseur maximale de la poignée Espesor máximo del mango mm	Max. Handle Width Largeur maximale de la poignée Ancho máximo del mango mm	Box Quantity Unité d'emballage Cantidad de cajas
V442	00452 0	1	7	135	104	78	10	23	1
V448	00453 7	1	8	305	221	114	24	43	1



## UNIVERSAL VALVE LOCKOUT



### TECHNOLOGY AND FEATURES

- Large, stable metal housing
- Ergonomically shaped rotary handle for quick adjustment
- Generous adjusting range
- Metallic and rubberized clamping areas for optimum grip on different surfaces
- One insertion point for threading through a wire lock/cable lockout device
- With embedded warning „Danger - Locked out“
- To secure valves against unintentional restart in case of maintenance works
- Locking ball valve handles by attaching an additional cable lockout device (not included in the delivery)
- Securing the OFF position by connecting to a counterpoint
- For all sizes and shapes of ball valve handles thanks to generous, adjustable clamping area

### CARACTÉRISTIQUES TECHNIQUES

- Grand boîtier métallique solide
- Poignée ergonomique pour un réglage rapide
- Grande plage de réglage
- Surfaces de serrage en métal et caoutchouc pour une prise optimale sur diverses surfaces
- Un point d'accrochage pour le passage d'un verrouillage par câble
- Avec signalisation intégrée « Danger - Locked out »
- Pour-le verrouillage des vannes contre toute remise en marche involontaire lors d'opérations de maintenance
- Verrouiller des leviers à main de vanne à boisseau sphérique grâce à un système de verrouillage par câble supplémentaire
- Verrouillage de la position fermée grâce à la liaison à un contrepoint
- Pour toutes les formes et dimensions de poignées de vannes à boisseau sphérique grâce à la vaste zone de serrage réglable

### CARACTERÍSTICAS TÉCNICAS

- Sólida carcasa de metal de gran volumen
- Empuñadura de giro ergonómica para un ajuste rápido
- Amplio margen de ajuste
- Superficies de fijación metálicas y engomadas para un agarre óptimo a distintas superficies
- Un punto de montaje para enhebrar un bloqueo de cuerda o cable
- Con mensaje de advertencia integrado "Danger - Locked out"
- Protección de válvulas frente a una reconexión accidental durante el mantenimiento
- Bloquear palancas de válvulas de bola mediante la colocación de un cable de bloqueo adicional
- Protección de la posición de apagado mediante la unión a un punto de fijación
- Para todos los tamaños y formas de empuñaduras de válvulas de bola gracias a su zona de ajuste amplia y regulable

Ref. No. Référence Referencia	EAN 4003318	Locking Points Points de fermetures Puntos de bloqueo	Shackle Diameter Diamètre d'anse Diámetro del grillete mm	Length Longueur Larga mm	Width Largeur Ancho mm	Depth Profondeur Profundidad mm	Max. Handle Thickness de la poignée Espesor máximo del mango mm	Max. Handle Width de la poignée Ancho máximo del mango mm	Box Quantity Unité d'emballage Cantidad de cajas
V500	87151 1	1	7	750	72	36			1
V500 Set	87152 8	6	9						1 (set containing 1 pc. V500 + 1 pc. C506 Safelex™ Cable Lockout)

# P110- 550

## POWER PLUG LOCKOUT



P550

Product Video

### TECHNOLOGY AND FEATURES

- High-quality polypropylene: long-lasting, robust and non-conductive
- 2 Sizes: For standard plugs or high-voltage plugs
- Cable tunnel on both sides to secure plug connections
- Warning stickers in different languages included
- Holds up to 4 padlocks with up to 9 mm shackle diameter

### CARACTÉRISTIQUES TECHNIQUES

- Polypropylène de haute qualité: durable, résistant, non conducteur
- Deux tailles: pour les connecteurs standard 110/220 V et pour les connecteurs à courant de haute intensité 550 V
- Passage de câble des deux côtés pour le verrouillage des connecteurs raccordés
- Étiquettes d'avertissement auto-adhésives en différentes langues
- Pour 1 à 4 cadenas présentant une anse jusqu'à 9 mm de diamètre

### CARACTERÍSTICAS TÉCNICAS

- Polipropileno de alta calidad: duradero, resistente, no conductor
- Dos tamaños: para enchufes comerciales estándar de 110/220 V hasta enchufes de alto voltaje de 550 V
- Pasador de cable a ambos lados para asegurar las conexiones del enchufe
- Señales de advertencia autoadhesivas en diferentes idiomas
- Para un máximo de cuatro candados con grilletes de hasta 9 mm de diámetro

Ref. No. Référence Referencia	EAN 4003318	Locking Points Points de fermetures Puntos de bloqueo	Shackle Diameter Diamètre d'anse Diámetro del grillete mm	Length Longueur Larga mm	Width Largeur Ancho mm	Depth Profondeur Profundidad mm	Cable Diameter Diamètre du câble Diámetro del cable mm	Inner Diameter Diamètre intérieur Diámetro interno mm	Box Quantity Unité d'emballage Cantidad de cajas
P110	00450 6	2	9	89	81	51	12	42	1
P550	00451 3	4	9	175	116	84	25	74	1

# P600

## UNIVERSAL PLUG LOCKOUT DEVICE



### TECHNOLOGY AND FEATURES

- High quality polypropylene, durable, resistant, non-conductive
- Self-adhesive warning sign
- For padlocks with shackle diameters of up to 7 mm
- Lightweight, handy and space-saving

### CARACTÉRISTIQUES TECHNIQUES

- Polypropylène de haute qualité, durable, résistant, non-conducteur
- Panneau d'avertissement auto-adhésif
- Pour un cadenas avec un diamètre d'anse jusqu'à 7 mm
- Léger, maniable et peu encombrant

### CARACTERÍSTICAS TÉCNICAS

- Polipropileno de alta calidad, duradero, resistente, no conductor
- Señal de advertencia autoadhesiva
- Para un candado con arco de hasta 7 mm de diámetro
- Ligero, manejable y compacto

Ref. No. Référence Referencia	EAN 4003318	Locking Points Points de fermetures Puntos de bloqueo	Shackle Diameter mm Diamètre d'anse mm Diámetro del grillete mm	Length mm Longueur mm Larga mm	Width mm Largeur mm Ancho mm	Depth mm Profondeur mm Profundidad mm	Box Quantity Unité d'emballage Cantidad de cajas
P600	85033 2	1	7	55	39	27	1

# P606

## GAS CYLINDER LOCKOUT



Product Video

### TECHNOLOGY AND FEATURES

- High-quality polypropylene: long-lasting, robust and non-conductive
- Warning sticker included
- Holds 1 padlock with up to 9 mm shackle diameter

### CARACTÉRISTIQUES TECHNIQUES

- Polypropylène de haute qualité: durable, résistant, non conducteur
- Étiquettes d'avertissement auto-adhésives
- Pour cadenas présentant une anse jusqu'à 9 mm de diamètre

### CARACTERÍSTICAS TÉCNICAS

- Polipropileno de alta calidad: duradero, resistente, no conductor
- Letrero de advertencia autoadhesivo
- Para un candado con grillete de un diámetro de hasta 9 mm

Ref. No. Référence Referencia	EAN 4003318	Locking Points Points de fermetures Puntos de bloqueo	Shackle Diameter Diamètre d'anse Diámetro del grillete mm	Length Longueur Larga mm	Width Largeur Ancho mm	Depth Profondeur Profundidad mm	Inner Diameter Diamètre intérieur Diámetro interno mm	Inside Height Hauteur intérieure Altura interior mm	Box Quantity Unité d'emballage Cantidad de cajas
P606	00449 0	1	9	159	132	88	78	139	1

## COMPRESSED AIR CONNECTION LOCKOUT



### TECHNOLOGY AND FEATURES

- Stainless steel: robust, durable, resistant
- Seven receptacles with different diameters between 7.5 and 20 mm
- Self-explanatory: intuitive and easy to use
- With LOTO warning embossed on both sides
- For up to two padlocks with shackles up to 8 mm thick

### CARACTÉRISTIQUES TECHNIQUES

- Acier inoxydable : robuste, durable, résistant
- Sept logements de différents diamètres entre 7,5 et 20 mm
- Auto-explicatif : intuitif et facile à utiliser
- Avec l'avertissement LOTO en relief sur les deux côtés
- Pour un maximum de deux cadenas jusqu'à 8 mm d'épaisseur d'anse

### CARACTERÍSTICAS TÉCNICAS

- Acero inoxidable: robusto, duradero y resistente
- Siete alojamientos con diferentes diámetros de entre 7,5 y 20 mm
- Autoexplicativo: intuitivo y fácil de usar
- Con advertencia LOTO en relieve por ambos lados
- Para hasta dos candados con arco de hasta 8 mm de grosor

Ref. No. Référence Referencia	EAN 4003318	Locking Points Points de fermetures Puntos de bloqueo	Shackle Diameter mm Diamètre d'anse mm Diámetro del grillete mm	Length mm Longueur mm Larga mm	Width mm Largeur mm Ancho mm	Depth mm Profondeur mm Profundidad mm	Box Quantity Unité d'emballage Cantidad de cajas
P604	64296 8	2	8	196	34	5,4	1

# P616 | P625

## CONTROL PANEL LOCKOUT DEVICE



P625

### TECHNOLOGY AND FEATURES

- Made from light yet durable polyester
- Drawstring closure
- Drawstring with five opposing metallic eyes for flexible closure

### CARACTÉRISTIQUES TECHNIQUES

- En polyester léger et robuste
- Verrouillage possible grâce au cordon coulissant
- Cordon avec 5 œillets métalliques opposés pour une fermeture flexible

### CARACTERÍSTICAS TÉCNICAS

- fabricado en poliéster ligero y robusto
- Con cierre gracias a la cinta de tracción
- Cinta de tracción con cinco ojales metálicos contrapuestos para un cierre flexible

Ref. No. Référence Referencia	EAN 4003318	Locking Points Points de fermetures Puntos de bloqueo	Shackle Diameter Diamètre d'anse Diámetro del grillete mm	Length Longueur Larga mm	Width Largeur Ancho mm	Depth Profondeur Profundidad mm	Inner Diameter Diamètre intérieur Diámetro interno mm	Inside Height Hauteur intérieure Altura interior mm	Box Quantity Unité d'emballage Cantidad de cajas
P616	86524 4	1	7	4500	160	160	160		1
P625	86525 1	1	7	4500	250	250	250		1

# ULC100

## WATER FOUNTAIN LOCKOUT DEVICE



Product Video

### TECHNOLOGY AND FEATURES

- Lightweight drawstring bag made of high quality, durable polyester for repeated use
- Secures plug valves and water fountain spouts with a stem diameter ranging from 3/4" to 2 1/2"
- Accommodates padlocks with shackle thickness up to 5/16"
- Imprint clearly identifies fountain spout cannot be used when installed
- Easy to install – no tools required
- Tamper resistant to ensure fountain spout is not accessible
- Foldable bag takes up minimal storage space

### CARACTÉRISTIQUES TECHNIQUES

- Sac à cordon léger en polyester durable de haute qualité pour un usage répété
- Permet de sécuriser les robinets à boisseau et les becs de fontaine dont le diamètre de la tige varie de 3/4" à 2 1/2"
- Convient aux cadenas dont l'épaisseur de l'anse peut atteindre 5/16"
- L'impression indique clairement que le bec ne peut pas être utilisé lorsqu'il est installé
- Facile à installer - aucun outil requis
- Inviolable pour garantir que le bec ne soit pas accessible
- Le sac pliable prend un minimum d'espace de rangement

### CARACTERÍSTICAS TÉCNICAS

- Bolsa ligera con cordón fabricada en poliéster de alta calidad y duradera para un uso continuado
- Asegura válvulas de macho y caños de fuentes de agua con vástagos de 3/4" a 2 1/2" de diámetro
- Admite candados con arcos de hasta 5/16" de grosor
- Cuando está instalado, la impresión identifica claramente que el caño de la fuente no se puede utilizar
- Fácil de instalar: no se necesitan herramientas
- A prueba de manipulaciones para garantizar que el caño de la fuente no sea accesible
- La bolsa plegable ocupa un espacio mínimo de almacenamiento

Ref. No. Référence Referencia	EAN 4003318	Locking Points Points de fermetures Puntos de bloqueo	Shackle Diameter mm Diamètre d'anse mm Diámetro del grillete mm	Length mm Longueur mm Larga mm	Width mm Largeur mm Ancho mm	Depth mm Profondeur mm Profundidad mm	Box Quantity Unité d'emballage Cantidad de cajas
ULC100	67748 9	6	8	95	95	140	1

# C503- 526

## SAFELEX™ UNIVERSAL-CABLE LOCKOUT

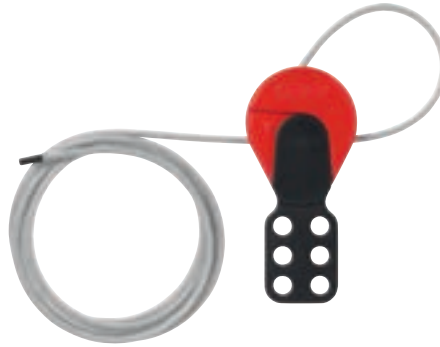

C523, C526



Product Video

### TECHNOLOGY AND FEATURES

- Intuitive design for self-explanatory application
- Patented grip mechanism for secure fixation of the cable
- Retightening possible at any time, even when locked
- Isolated, exchangeable metal cable in different lengths
- Holds up to 6 padlocks

### CARACTÉRISTIQUES TECHNIQUES

- Une conception intuitive pour la facilité d'utilisation
- Mécanisme de blocage breveté pour la fixation du câble
- Peut être resserré à tout moment – même dans l'état verrouillé
- Câbles métalliques isolés et remplaçables de différentes longueurs
- Jusqu'à six cadenas

### CARACTERÍSTICAS TÉCNICAS

- Diseño intuitivo para un uso sin complicaciones
- Mecanismo patentado de sujeción para fijar el cable de forma segura
- Retensable en todo momento, incluso en el estado bloqueado
- Cable metálico aislado y extraíble de diferentes longitudes
- Para un máximo de seis candados

Ref. No. Référence Referencia	EAN 4003318	Locking Points Points de fermetures Puntos de bloqueo	Shackle Diameter Diamètre d'anse Diámetro del grillete mm	Length Longueur Larga mm	Width Largeur Ancho mm	Depth Profondeur Profundidad mm	Cable Length Longueur de câble Longitud del cable mm	Cable Diameter Diamètre du câble Diámetro del cable mm	Box Quantity Unité d'emballage Cantidad de cajas
C503	00347 9	6	9	128	61	26	1000	4,1	1
C506	00348 6	6	9	128	61	26	2000	4,1	1
C509	00349 3	6	9	128	61	26	3000	4,1	1
C515	00353 0	6	9	128	61	26	5000	4,1	1
C523 Nylon	77842 1	6	9	128	61	26	1000	4,6	1
C526 Nylon	77843 8	6	9	128	61	26	2000	4,6	1
<b>Replacement cable   Câble de remplacement   cable de repuesto</b>									
C503SC	85615 0						1000	4,1	1
C506SC	85616 7						2000	4,1	1
C509SC	85617 4						3000	4,1	1
C515SC	85618 1						5000	4,1	1
C523SC Nylon	85619 8						1000	4,6	1
C526SC Nylon	85620 4						2000	4,6	1



# C553 - C565

## STANDARD - CABLE LOCKOUT



Product Video

### TECHNOLOGY AND FEATURES

- Intuitive design for self-explanatory application
- Isolated, exchangeable metal cable in different lengths
- Holds up to 6 padlocks

### CARACTÉRISTIQUES TECHNIQUES

- Une conception intuitive pour la facilité d'utilisation
- Câbles métalliques isolés et remplaçables de différentes longueurs
- Jusqu'à six cadenas

### CARACTERÍSTICAS TÉCNICAS

- Diseño intuitivo para un uso sin complicaciones
- Cable metálico aislado y extraíble de diferentes longitudes
- Para un máximo de seis candados

Ref. No. Référence Referencia	EAN 4003318	Locking Points Points de fermetures Puntos de bloqueo	Shackle Diameter Diamètre d'anse Diámetro del grillete mm	Length Longueur Larga mm	Width Largeur Ancho mm	Depth Profondeur Profundidad mm	Cable Length Longueur de câble Longitud del cable mm	Cable Diameter Diamètre du câble Diámetro del cable mm	Box Quantity Unité d'emballage Cantidad de cajas
C553	00355 4	6	7	128	61	16	1000	4,1	1
C556	00356 1	6	7	128	61	16	2000	4,1	1
C559	00359 2	6	7	128	61	16	3000	4,1	1
C565	00361 5	6	7	128	61	16	5000	4,1	1

# H701- H712

## STEEL LOCKOUT HASP



H702 yellow



H711 red



Product Video

### TECHNOLOGY AND FEATURES

- Vinyl coated high tensile steel
- Available with or without pry-resistant interlocking tabs for additional security
- Holds up to 6 padlocks

### CARACTÉRISTIQUES TECHNIQUES

- Acier cémenté : sûr et robuste
- En option avec attaches transversales pour une protection supplémentaire
- Jusqu'à six cadenas

### CARACTERÍSTICAS TÉCNICAS

- Diseño intuitivo para un uso sin complicaciones
- Cable metálico aislado y extraíble de diferentes longitudes
- Para un máximo de seis candados

Ref. No. Référence Referencia	EAN 4003318	Locking Points Points de fermetures Puntos de bloqueo	Shackle Diameter mm Diamètre d'anse mm Diámetro del grillete mm	Length mm Longueur mm Larga mm	Width mm Largeur mm Ancho mm	Depth mm Profondeur mm Profundidad mm	Box Quantity Unité d'emballage Cantidad de cajas
H701 red	35766 4	6	9	115	45	10	12
H701 yellow	35767 1	6	9	115	45	10	12
H702 red	35768 8	6	9	128	60	10	12
H702 yellow	35769 5	6	9	128	60	10	12
H711 red	33551 8	6	9	118	45	12	12
H712 red	33552 5	6	9	131	60	12	12

# H751- H752

## ALUMINUM LOCKOUT HASP



H752



### TECHNOLOGY AND FEATURES

- Aluminum: Light and corrosion-resistant
- Holds up to 6 padlocks

### CARACTÉRISTIQUES TECHNIQUES

- Aluminium: légère, non-corrosif
- Jusqu'à six cadenas

### CARACTERÍSTICAS TÉCNICAS

- Aluminio: ligero, resistente a la corrosión
- Para un máximo de seis candados

Ref. No. Référence Referencia	EAN 4003318	Locking Points Points de fermetures Puntos de bloqueo	Shackle Diameter mm Diamètre d'anse mm Diámetro del grillete mm	Length mm Longueur mm Larga mm	Width mm Largeur mm Ancho mm	Depth mm Profondeur mm Profundidad mm	Box Quantity Unité d'emballage Cantidad de cajas
H751 red	00302 8	6	9	112	40	10	12
H752 red	003440 0	6	9	124	50	10	12

# H770

## PLASTIC LOCKOUT HASP

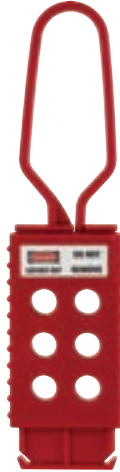

### TECHNOLOGY AND FEATURES

- High-quality nylon: Long-lasting, light and non-conductive
- Holds up to 6 padlocks

### CARACTÉRISTIQUES TECHNIQUES

- Nylon haute qualité: durable, léger, non conducteur
- Jusqu'à six cadenas

### CARACTERÍSTICAS TÉCNICAS

- Nylon de alta calidad: Resistente, ligero, dieléctrico
- Para un máximo de seis candados

Ref. No. Référence Referencia	EAN 4003318	Locking Points Points de fermetures Puntos de bloqueo	Shackle Diameter mm Diamètre d'anse mm Diámetro del grillete mm	Length mm Longueur mm Larga mm	Width mm Largeur mm Ancho mm	Depth mm Profondeur mm Profundidad mm	Box Quantity Unité d'emballage Cantidad de cajas
H770	00346 2	6	9	177	44	12	12

# SAFETY REDBOX™

LOCKOUT OF LARGE MACHINERY OR PLANTS WITH MANY DIFFERENT ACCESS POINTS



Product Video

## TECHNOLOGY AND FEATURES

- High level of stability in spite of low weight
- Ergonomic and space-saving fold-away handle
- Inside is exposed to light from all sides for better visibility of contents
- Lid features innovative and secure locking mechanism
- Patented wall bracket, also facilitates storing of padlocks

## CARACTÉRISTIQUES TECHNIQUES

- Faible poids et haute stabilité
- Amélioration de la lumière incidente de tous les côtés pour une meilleure visibilité
- Mécanisme de fermeture du couvercle innovant et sûr
- Montage mural breveté – peut également être utilisé pour le rangement des cadenas

## CARACTERÍSTICAS TÉCNICAS

- Peso reducido y una elevada estabilidad
- Ergonómica, ahorra de espacio y cuenta con un mango plegable
- Iluminación mejorada desde todos los lados para una mejor visualización
- Mecanismo de cierre de la tapa innovador y seguro
- Montaje en pared patentado, también para útil para almacenar los candados

Ref. No. Référence Referencia	EAN 4003318	Locking Points Points de fermetures Puntos de bloqueo	Shackle Diameter Diamètre d'anse Diámetro del grillete mm	Length Longueur Larga mm	Width Largeur Ancho mm	Depth Profondeur Profundidad mm	Wallet Bracket Support mural Soporte de billetera	Box Quantity Unité d'emballage Cantidad de cajas
8835	00298 4	12	7	240	174	94	174 x 40 x 20	1
<b>Spare wall bracket   Support mural de remplacement   Soporte de pared de repuesto</b>								
8835WB	77771 4			174	40	20		

## PERMIT-TO-WORK



### TECHNOLOGY AND FEATURES

- Stable box made of powder-coated metal sheet
- Large, lockable front pane to display the dedicated work permit notes (A4 format)
- With 20 insertion holes for personal LOTO locks plus additional 3 for authorized persons
- Large storage space with hook rails to store up to 24 machine padlocks
- With carrying handle for mobile use
- With enclosed wall-bracket for stationary use of the box
- Inside with quick-release-button to optionally fix the box on the wall-bracket
- All around with punched holes for better light incidence and insight
- Side with insertion slot for keys with key tag

### CARACTÉRISTIQUES TECHNIQUES

- Boîtier stable en tôle d'acier à revêtement par poudrage
- Large fenêtre avant verrouillable pour le stockage d'attestations d'autorisation de travail (format A4)
- Avec 20 emplacements pour cadenas personnels et 3 emplacements supplémentaires pour le personnel autorisé
- Grand espace de rangement avec barre à crochets pour jusqu'à 24 cadenas de machine
- Avec poignée de transport pour une utilisation mobile
- Avec support mural pour une utilisation fixe du boîtier
- Bouton de déclenchement rapide à l'intérieur pour fixation du boîtier en option sur le support mural
- Perforations tout autour du boîtier pour une meilleure lumière incidente et visibilité
- Fente latérale pour y déposer les clés et porte-clés

### CARACTERÍSTICAS TÉCNICAS

- Caja estable fabricada en de chapa de acero recubierta
- Parte frontal grande y con cierre para el alojamiento de certificados de permiso de trabajo (formato A4)
- Con 20 alojamientos para candados personales más 3 adicionales para personas autorizadas
- Mayor espacio de almacenamiento con ganchos para hasta 24 candados de máquinas
- Con asa de transporte
- Con soporte de pared adjunto para el uso fijo de la caja
- Interior con pomo de activación rápida para la fijación opcional de la caja al soporte de pared
- Completo con orificios para una mejor incidencia de la luz y visión
- Lateral con ranura de introducción para llave, incl. llavero

Ref. No. Référence Referencia	EAN 4003318	Locking Points Points de fermetures Puntos de bloqueo	Shackle Diameter Diamètre d'anse Diámetro del grillete mm	Length Longueur Larga mm	Width Largeur Ancho mm	Depth Profondeur Profundidad mm	Wallet Bracket Support mural Soporte de billetera	Box Quantity Unité d'emballage Cantidad de cajas
B810	88882 3	23	7	380	240	68	1	

# T100/T150

## LOTO-TAGS IN THE HANDY DISPENSER



Dispenser Box T100

Dispenser Box T150

T150 German

T150 French

T150 Spanish

T150 Swedish

### TECHNOLOGY AND FEATURES

- Made of indestructible polypropylene synthetic paper
- With labelling fields on the back
- Available in five different languages
- Reclosable box with 9 mm punch hole for hooks (dim. 144 x 33 x 29 mm)
- In accordance with ASR A1.3 Labelling Directive, point 3.3. and point 5/5.1, section 6, 8, 9 DIN EN ISO 7010

### CARACTÉRISTIQUES TECHNIQUES

- En papier synthétique en polypropylène indestructible
- Avec champs d'inscription sur le verso
- Disponible en cinq langues différentes
- Boîte refermable avec perforation de 9 mm pour les crochets (dimension : 144 x 33 x 29 mm)
- Selon la directive d'étiquetage ASR A1.3 point 3.3. et point 5/5.1 paragraphe 6, 8, 9 DIN EN ISO 7010

### CARACTERÍSTICAS TÉCNICAS

- Fabricadas en papel sintético muy resistente de polipropileno
- Con campos de rotulación en la parte trasera
- Disponible en cinco idiomas diferentes
- Caja recerrable con orificio de 9 mm para ganchos (dimensiones: 144 x 33 x 29 mm)
- Según la directriz de marcado ASR A1.3, punto 3.3. y punto 5/5.1, párrafo 6, 8, 9 DIN EN ISO 7010

Ref. No. Référence Referencia	EAN 4003318	Variants Exécutions Variantes	Dispenser-Box			Tags		Box Quantity Unité d'emballage Cantidad de cajas
			Length Longueur Larga mm	Width Largeur Ancho mm	Depth Profondeur Profundidad mm	Length Longueur Larga mm	Width Largeur Ancho mm	
T100 LOTO-Tag small German	77806 3	Dispenser à 100 Tags	33	172	29	32	140	1
T100 LOTO-Tag small French	77808 7	Dispenser à 100 Tags	33	172	29	32	140	1
T100 LOTO-Tag small English	77807 0	Dispenser à 100 Tags	33	172	29	32	140	1
T100 LOTO-Tag small Spanish	78298 5	Dispenser à 100 Tags	33	172	29	32	140	1
T100 LOTO-Tag small Swedish	77809 4	Dispenser à 100 Tags	33	172	29	32	140	1
T150 LOTO-Tag large German	77798 1	Dispenser à 100 Tags	78	178	29	76	146	1
T150 LOTO-Tag large French	77802 5	Dispenser à 100 Tags	78	178	29	76	146	1
T150 LOTO-Tag large English	77801 8	Dispenser à 100 Tags	78	178	29	76	146	1
T150 LOTO-Tag large Spanish	78299 2	Dispenser à 100 Tags	78	178	29	76	146	1
T150 LOTO-Tag large Swedish	77803 2	Dispenser à 100 Tags	78	178	29	76	146	1

# LOCKPOINT

## THE STORAGE SYSTEM FOR LOTO



LockPoint  
Wandbefestigung



LockPoint Fuß RL



Fahrgestell mit Doppelrollen



Product Video

### TECHNOLOGY AND FEATURES

- Modular system for storing lockout/tagout locks and locking devices
- Stable, durable and easy-to-clean metal storage solution
- Customisable design according to customer's wishes for every LockPoint
- 2 different sizes and 3 variants
- The LockPoint can be combined with documents, work instructions, permit-to-work procedures and group processes
- Complies with the 60-second rule, whereby all materials should be available within one minute

### CARACTÉRISTIQUES TECHNIQUES

- Rangement modulaire des cadenas et verrouillages Lockout/Tagout
- Solution de rangement métallique stable, durable et facile à nettoyer
- Conception individuelle de chaque LockPoint selon les besoins du client
- 2 tailles différentes en 3 variantes
- Combinable avec la documentation, les instructions de travail, les procédures d'autorisation de travail et les processus de groupe
- Respect de la règle des 60 secondes, selon laquelle tout le matériel doit être disponible dans la minute

### CARACTERÍSTICAS TÉCNICAS

- Sistema modular para almacenar los candados y bloqueos de lockout/tagout
- Solución de almacenamiento de metal, robusta, duradera y fácil de limpiar
- Diseño personalizado de cada LockPoint según las necesidades del cliente • dos tamaños diferentes en 3 versiones
- Se puede combinar con documentaciones, instrucciones de trabajos, procedimientos de permisos de trabajo y procesos de grupo
- Cumplimiento de la regla de los 60 segundos, según la cual todos los materiales deben estar disponibles en un minuto

Ref. No. Référence Referencia	EAN 4003318	Variants Exécutions Variantes	Box Quantity Unité d'emballage Cantidad de cajas
LockPoint basic set	77966 4	Two-piece perforated wall, two-piece side stands, 1 x "LockPoint" display attachment, 1 x "LockPoint" insert, 1 x traverse lock store for up to 20 locks	1
<b>+ VERSION (important: Specify when selecting the LockPoint basic set)</b>			
LockPoint wall mount	77944 2	Set consists of 6 wall mounts including bolts for the LockPoint	1
LockPoint feet RL set, two-piece	77952 7	Two-part standing feet set R/L for the LockPoint	1
LockPoint chassis with double rollers	77963 3	Two-part roller frame for the LockPoint	1
<b>+ PRODUCT LEVEL OPTION</b>			
LockPoint traverse lock store	77947 3	Lock store for up to 20 locks, height-adjustable	1
LockPoint bin	77948 0	Product chute (internal and external bin)	1
LockPoint bin compartment 40 cm	77949 7	Product chute dividers	1
<b>+ ORGANISATIONAL LEVEL OPTION</b>			
LockPoint DIN A4 document pocket	77953 4	Set with 10 pcs (5 x blue, 5 x red) removable document pockets for DIN A4 paper	1
LockPoint document pocket bracket	77964 0	Bracket for up to 10 document pockets	1
LockPoint DIN A4 writing shelf	77946 6	Height-adjustable DIN A4 writing pad	1
Hook for LockPoint (Eurocode)	28246 1	Insertable hooks for devices, hasps etc.	1
Hook for LockPoint	82634 4	Insertable hooks to hang hasps, tags etc.	1
Bracket for LOTO tags	86796 5	LockPoint bracket for side by side LOTO tag dispenser boxes	1



# LOCKPOINT SINGLEWALL

THE SMALL VERSION OF THE LOCKPOINT



## TECHNOLOGY AND FEATURES

- Modular system for storing lockout/tagout locks and locking devices
- Stable, durable and easy-to-clean metal storage solution
- Customisable design according to customer's wishes for every LockPoint
- The LockPoint can be combined with documents, work instructions, permit-to-work procedures and group processes
- Complies with the 60-second rule, whereby all materials should be available within one minute

## CARACTÉRISTIQUES TECHNIQUES

- Rangement modulaire des cadenas et verrouillages Lockout/Tagout
- Solution de rangement métallique stable, durable et facile à nettoyer
- Conception individuelle de chaque LockPoint selon les besoins du client
- Combinable avec la documentation, les instructions de travail, les procédures d'autorisation de travail et les processus de groupe
- Respect de la règle des 60 secondes, selon laquelle tout le matériel doit être disponible dans la minute

## CARACTERÍSTICAS TÉCNICAS

- Sistema modular para almacenar los candados y bloqueos de lockout/tagout
- Solución de almacenamiento de metal, robusta, duradera y fácil de limpiar
- Diseño personalizado de cada LockPoint según las necesidades del cliente • dos tamaños diferentes en 3 versiones
- Se puede combinar con documentaciones, instrucciones de trabajos, procedimientos de permisos de trabajo y procesos de grupo
- Cumplimiento de la regla de los 60 segundos, según la cual todos los materiales deben estar disponibles en un minuto

Ref. No. Référence Referencia	EAN 4003318	Variants Exécutions Variantes	Box Quantity Unité d'emballage Cantidad de cajas
LockPoint SingleWall basic set	82629 0	one-piece perforated wall, two-piece side stands, 1 x "LockPoint" decal 1 x traverse lock store, 4 x wall mounts with bolts	1
<b>+ PRODUCT LEVEL OPTION</b>			
LockPoint traverse lock store	77947 3	Lock store for up to 20 locks, height-adjustable	1
LockPoint basket for the SingleWall	82625 2	Product chute (half depth for SingleWall)	1
<b>+ ORGANISATIONAL LEVEL OPTION</b>			
LockPoint DIN A4 document pocket	77953 4	Set with 10 pcs (5 x blue, 5 x red) removable document pockets for DIN A4 paper	1
LockPoint document pocket bracket	77964 0	Bracket for up to 10 document pockets	1
LockPoint DIN A4 writing shelf	77946 6	Height-adjustable DIN A4 writing pad	1
Hook for LockPoint (Eurocode)	28246 1	Insertable hooks for devices, hasps etc.	1
Hook for LockPoint	82634 4	Insertable hooks to hang hasps, tags etc.	1
Bracket for LOTO tags	86796 5	LockPoint bracket for side by side LOTO tag dispenser boxes	1

# SL BAGS

## LOTO BAGS



SL130



SL120

### TECHNOLOGY AND FEATURES

- Bags available in two sizes
- Lightweight material (polyester)
- Thanks to the polyurethane coating, the bag is extremely flexible, water-repellent and resistant to heat and dirt
- 2-way zip
- Belt loop on the back

### CARACTÉRISTIQUES TECHNIQUES

- Sacs disponibles en deux tailles
- Matériau léger (polyester)
- Flexibles, hydrofuges et résistants à la chaleur et à la saleté grâce à un revêtement en polyuréthane
- Fermeture éclair
- Passe-ceinture au verso

### CARACTERÍSTICAS TÉCNICAS

- Bolsas disponibles en dos tamaños
- Material ligero (poliéster)
- Muy flexibles, hidrófugas y resistentes al calor y a la suciedad gracias al revestimiento de poliuretano
- Cierre con cremallera doble
- Trabilla en la parte trasera

Ref. No. Référence Referencia	EAN 4003318	Length mm Longueur mm Larga mm	Width mm Largeur mm Ancho mm	Depth mm Profondeur mm Profundidad mm	Box Quantity Unité d'emballage Cantidad de cajas
SL Bag 130	77235 1	190	190	85	1
SL Bag 120	72656 9	180	120	45	1

# LOCKOUT / TAGOUT SETS



LoTo kit example: „mechanically small“



LoTo kit example: „electrically small“

## TECHNOLOGY AND FEATURES

- Bags available in two sizes
- Lightweight material (polyester)
- Thanks to polyurethane coating, the bag is extremely flexible, water-repellent and resistant to heat and dirt
- Zip fastener
- Belt loop on the back

## CARACTÉRISTIQUES TECHNIQUES

- Sacs disponibles en deux tailles
- Matériau léger (polyester)
- Grâce au revêtement en polyuréthane, le sac est extrêmement souple, hydrofuge et résistant à la chaleur et à la saleté
- Fermeture éclair
- Passant de ceinture à l'arrière

## CARACTERÍSTICAS TÉCNICAS

- Bolsas disponibles en dos tamaños
- Material ligero (poliéster)
- Gracias al recubrimiento de poliuretano, la bolsa es extremadamente flexible, hidrófuga y resistente al calor y la suciedad
- Cierre de zip
- Bucle de cinta en la parte posterior

### External dimensions Dimensions extérieures Dimensiones exteriores

Ref. No. Référence Referencia	EAN 4003318	Version Exécution Versión	Length mm Longueur mm Larga mm	Width mm Largeur mm Ancho mm	Depth mm Profondeur mm Profundidad mm	Finish Coloris Color	Box Quantity Unité d'emballage Cantidad de cajas
SL8ELEC76PS	79113 0	SL8ELEC76PS LoTo Kit electrical small: 76PS/40 red, H770, E203, E212, T100 EN, C503	190	190	85	red	1
SL8MECH76BS	79829 0	SL8MECH76BS LoTo Kit mechanical small: 76BS/40 red, H701, V500, P604, T100 EN, C506	190	190	85	red	1

# ABUS SUPPORTBOX



SupportBox | 88486 3

In order to simplify distribution of your individual safety padlocks to employees, ABUS has developed an innovative form of packaging: the ABUS SupportBox.

Thanks to the unique lock packaging, you can instantly see which lock should be assigned to which employee and which machine – this significantly reduces the amount of organisational work you have to do.

You can add the ABUS SupportBox as an alternative form of packaging from an order quantity of 90 locks.

Afin de vous simplifier la distribution des cadenas de sécurité individuels aux collaborateurs, ABUS a mis au point un nouveau type d'emballage : la SupportBox ABUS.

L'emballage spécial des cadenas vous permet de voir en un coup d'oeil quel cadenas doit être attribué à quel collaborateur ou à quelle machine : vos efforts d'organisation sont considérablement réduits.

À partir de 90 cadenas commandés, vous pouvez opter pour la SupportBox ABUS en tant qu'emballage alternatif.

Para que le resulte más fácil distribuir sus candados Safety entre los trabajadores, ABUS ha desarrollado un tipo de embalaje novedoso: la ABUS SupportBox.

Este embalaje especial para los candados le permitirá identificar de un solo vistazo el candado que debe asignar a cada empleado o a cada máquina, con lo que se reduce enormemente el esfuerzo organizativo.

A partir de un pedido de 90 candados, puede encargar la ABUS SupportBox como embalaje alternativo



### TECHNOLOGY AND FEATURES

- Made of high-quality materials
- Intended for Realistic, practical lockout/tagout training.
- It is suitable for yearly instruction, follow-up training or general briefing and instruction of outside companies, for example
- Electrical and mechanical energy points are included for this purpose
- Training can be successfully conducted outside of normal operations

### CARACTÉRISTIQUES TECHNIQUES

- Fabriqué avec des matériaux de haute qualité
- Destiné à une formation pratique et réaliste de verrouillage/étiquetage
- Il convient pour l'instruction annuelle, la formation de suivi ou le briefing général et l'instruction d'entreprises extérieures, par exemple
- Des points d'énergie électrique et mécanique sont prévus à cet effet
- La formation peut être menée avec succès en dehors des opérations normales

### CARACTERÍSTICAS TÉCNICAS

- Hecho de materiales de calidad
- Diseñado para realizar formaciones prácticas sobre lockout/tagout
- Idónea para formaciones anuales, cursos de capacitación complementaria o formaciones generales, por ejemplo, para empresas externas
- Incorpora puntos de energía eléctricos y mecánicos
- Permite que las formaciones pueden realizarse al margen de la producción habitual

Ref. No. Référence Referencia	EAN 4003318	Length mm Longueur mm Larga mm	Width mm Largeur mm Ancho mm	Depth mm Profondeur mm Profundidad mm	Box Quantity Unité d'emballage Cantidad de cajas
Trainingstower LoTo empty	96264 6	680	450	360	1



Are you planning an event to remember and wish to present the topic of occupational safety?  
With ABUS, you can turn your event into a show and allow your employees to experience Lockout/Tagout!

Our mighty 650 kg lady "EMMA" offers you the chance to simulate everyday isolating procedures in a fun, playful way. The mechanical and electrical energy sources are secured under steam and acoustics.  
If everything runs on time, we also have a wonderful competition known to awaken participants' ambition.

In addition, a guide/moderator is always provided alongside EMMA. We would be delighted to help you plan your next show.

Simply contact us!

Vous planifiez un événement dont tout le monde se souviendra et souhaitez faire une présentation sur le thème de la sécurité au travail ?  
Avec ABUS, faites de votre événement un spectacle et faites découvrir la consignation à vos collaborateurs !

Notre « EMMA », cette imposante dame de 650 kg, vous offre la possibilité de simuler de manière ludique les procédures de mise hors service quotidiennes. Les sources d'énergie mécaniques et électriques sont protégées contre les vapeurs et l'acoustique. Et si le tout est chronométré, l'événement se transforme en une belle compétition qui a déjà éveillé l'ambition de nombreuses personnes.

De plus, EMMA est toujours escortée par un accompagnateur ou un animateur. Nous nous ferons un plaisir de planifier avec vous votre prochain spectacle.

N'hésitez pas à nous contacter !

¿Está planeando un evento y quiere hablar sobre seguridad en el trabajo?

¡Con ABUS, convierta su evento en un show y deje que sus trabajadores experimenten el lockout/tagout!

Nuestra instalación "EMMA", de 650 kg, le ofrece la posibilidad de simular procesos de desconexión cotidianos como si fuera un juego. El equipo permite simular bloqueos de fuentes de energía mecánicas y eléctricas y cuenta con efectos de sonido y vapor. Si se realiza a contrarreloj, se pueden organizar competiciones que seguro que despertarán la ambición de los trabajadores.

Además, siempre acude una persona de acompañamiento o moderación con EMMA. Estaremos encantados de poder planificar juntos su próximo show.

¡Póngase en contacto con nosotros!

# DOOR CYLINDERS

---



# DOOR CYLINDERS



**B5LT**



**T112/ T114**



**A93**



**D6 Basic**

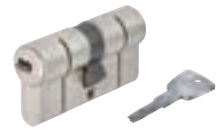

**D10PS**

<b>Double cylinder</b>	yes	yes	yes	yes	yes
<b>Half cylinder</b>	yes	yes / -	yes	yes	yes
<b>Knob cylinder</b>	-	-	yes	yes	yes
<b>Short cylinder</b>	-	yes	yes	-	-
<b>Exterior cylinder</b>	-	-	yes	-	yes
<b>(Service) cylinder 0-bitted</b>	-	yes	yes	yes	-
<b>Type of packing</b>	Individual box	Individual box / Carded	Individual box	Individual box / Carded	Individual box (H-Box)
<b>Security card / Code card</b>	-	-	-	-	Code card
<b>Manufactured according to Standards</b>	EN 1303 ISO 9001:2008	EN 1303 ISO 9001:2008	DIN EN1303 DIN 18252 ISO 9001:2008	EN 1303 DIN 18252 ISO 9001:2008	EN 1303 DIN 18252 ISO 9001:2008
<b>Certified for use in fire doors</b>	-	-	yes	-	-
<b>Approved by SKG</b>	-	-	-	-	SKG**
<b>Key system</b>	Conventional key system	Conventional key system	Conventional key system	reversible key	reversible key
<b>Number of pins</b>	5	5	5	6	10
<b>Levels of pins</b>	1	1	1	1	2
<b>Emergency feature</b>	-	- / yes	yes	-	yes
<b>Anti-drill protection</b>	-	-	yes	yes	yes
<b>Anti-Bumping protection</b>	-	-	-	-	-
<b>Number of keys</b>	3	3	3	5	5
<b>Colour</b>	lacquered Titanium	silver	nickel pearl	- satin nickel plated - matt brass	nickel pearl



# B5LT

## DOOR CYLINDER WITH CONVENTIONAL KEY

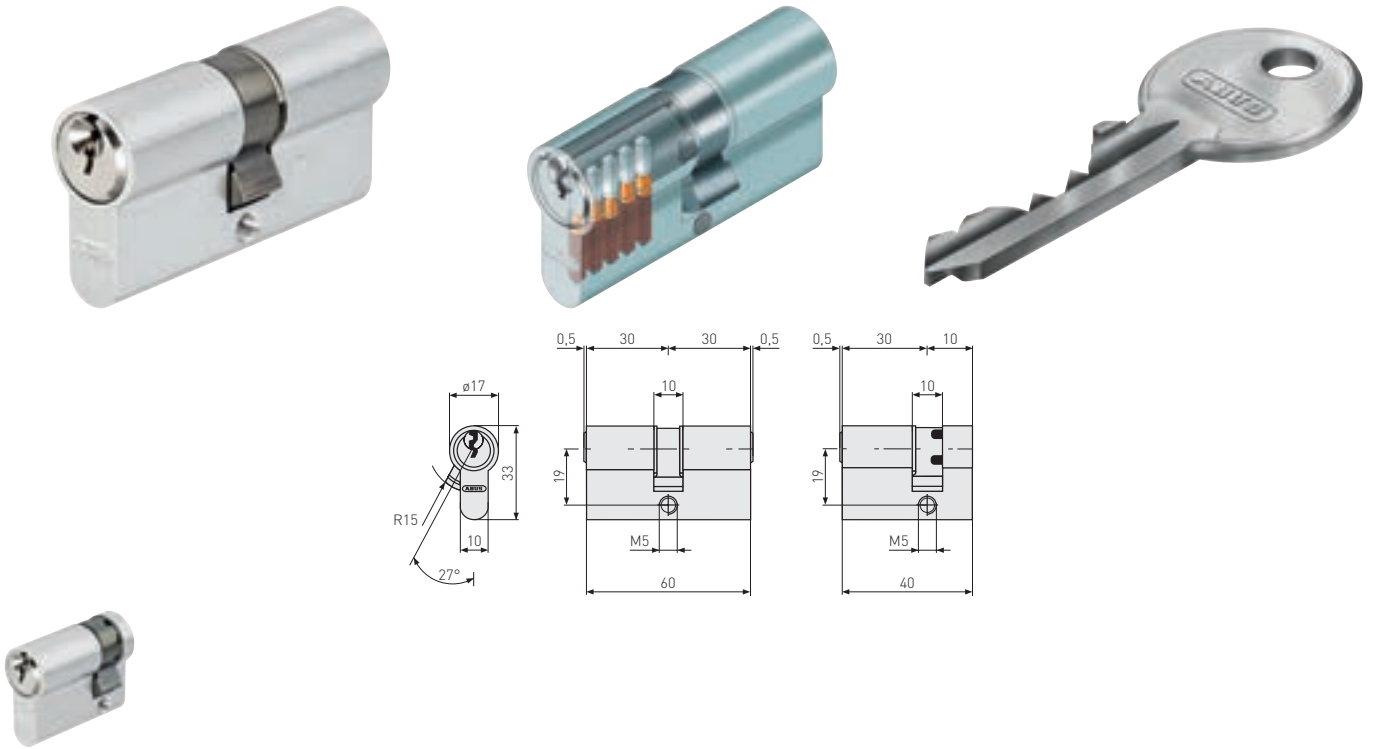

### TECHNOLOGY AND FEATURES

- Manufactured according to DIN EN 1303, ISO 9001:2008
- Cylinder made of Titalium special aluminium
- Paracentric keyway for better picking resistance
- 5-pin cylinder
- Incl. three keys

### CARACTÉRISTIQUES TECHNIQUES

- Conforme aux normes DIN EN 1303, ISO 9001:2008
- Corps de cylindre en aluminium spécial TITALIUM
- Profil de clé paracentrique contre les tentatives d'ouverture ingénieuses
- Cylindre à 5 pistons
- Y compris trois clés

### CARACTERÍSTICAS TÉCNICAS

- Fabricados siguiendo las normas DIN EN 1303, ISO 9001:2008
- Cuerpo del cilindro de aluminio especial TITALIUM
- Perfil de llave paracéntrico como protección ante intentos de apertura sofisticados
- Cilindro de 5 pernos
- Se incluyen tres llaves

Ref. No. Référence Referencia	EAN 4003318	Version Exécution Versión	Finish Coloris Color	Level Degré Nivel	Box Quantity Unité d'emballage Cantidad de cajas
B5LT 10/30 vs.	42001 6	Half cylinder	Lacquered Titalium		10
B5LT 10/35 vs.	08702 8	Half cylinder	Lacquered Titalium		10
B5LT 28/34 vs.	08704 2	Double cylinder	Lacquered Titalium		10
B5LT 30/30 vs.	08706 6	Double cylinder	Lacquered Titalium		10
B5LT 30/35 vs.	08707 3	Double cylinder	Lacquered Titalium		10
B5LT 30/40 vs.	42003 0	Double cylinder	Lacquered Titalium		10
B5LT 30/45 vs.	08709 7	Double cylinder	Lacquered Titalium		10
B5LT 30/50 vs.	08710 3	Double cylinder	Lacquered Titalium		10
B5LT 35/35 vs.	08712 7	Double cylinder	Lacquered Titalium		10
B5LT 35/40 vs.	08714 1	Double cylinder	Lacquered Titalium		10
B5LT 35/45 vs.	08715 8	Double cylinder	Lacquered Titalium		10
B5LT 35/50 vs.	08716 5	Double cylinder	Lacquered Titalium		10
B5LT 35/55 vs.	80330 7	Double cylinder	Lacquered Titalium		10
B5LT 40/40 vs.	08718 9	Double cylinder	Lacquered Titalium		10
B5LT 40/45 vs.	08719 6	Double cylinder	Lacquered Titalium		10
B5LT 40/50 vs.	08720 2	Double cylinder	Lacquered Titalium		10
B5LT 45/45 vs.	08721 9	Double cylinder	Lacquered Titalium		10
B5LT 45/50 vs.	42004 7	Double cylinder	Lacquered Titalium		10
KB5LT Z30/K30 vs.	81869 1	Knob cylinder	Lacquered Titalium		10
KB5LT Z40/K40 vs.	87833 6	Knob cylinder	Lacquered Titalium		10
Key Blank E50/E55/B5	27582 1		Lacquered Titalium		50

# TI12/TI14

## DOOR CYLINDER WITH CONVENTIONAL KEY

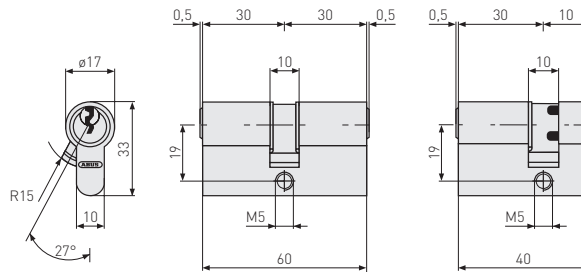

TI14

### TECHNOLOGY AND FEATURES

- Manufactured according DIN EN 1303
  - Cylinder Made of Titalium special aluminium
  - Special picking protection thanks to the paracentric keyway
  - 5-pin cylinder
  - Incl. 3 keys with tulip-shaped key head (brass, nickel-plated)
  - Attractive satin mat finish, similar to the popular nickel pearl finish
  - ABUS Global Protection Standard (GPS) 4
- TI14:
- Emergency feature: The cylinder can be operated from the outside even when a key is already inserted on the inside
  - Conversion set KT114 for conversion to a knob cylinder optionally available

### CARACTÉRISTIQUES TECHNIQUES

- Selon la norme DIN EN 1303
  - Corps de cylindre en aluminium spécial TITANIUM
  - Protection spéciale contre le crochetaje grâce au profil de clé paracentrique
  - Technologie à 5 broches
  - 3 clés incluses avec tête de clé moderne ABUS (laiton, nickelé)
  - Finition attrayante « satin mat », similaire à la coloration nickel perlé très appréciée
  - ABUS Global Protection Standard (GPS) 4
- TI14:
- Avec fonction débrayable (verrouillable des deux côtés, même si la clé est insérée à l'intérieur)
  - Kit de conversion KT114 pour la conversion en cylindre à bouton disponible en option

### CARACTERÍSTICAS TÉCNICAS

- Según la norma DIN EN 1303
  - Cuerpo del cilindro de aluminio especial TITANIUM
  - Protección especial contra el picking gracias al perfil paracentrico de la llave
  - Tecnología de 5 pernos
  - Incluye 3 llaves con el moderno cabezal ABUS (latón, niquelado)
  - Atractivo acabado „mate satinado“, similar al popular color níquel perlado
  - ABUS Global Protection Standard (GPS) 4
- TI14:
- Con función de peligro y emergencias (cierra por ambos lados, aunque la llave siga insertada en la cerradura)
  - Kit de adaptación KT114 disponible opcionalmente para la conversión a cilindro de botón

Ref. No. Référence Referencia	EAN 4003318	Version Exécution Versión	Finish Coloris Color	Level Degré Nível	Box Quantity Unité d'emballage Cantidad de cajas
TI12ST 10/30 vs.	05522 5	Half cylinder	silver	4	10
TI12ST 10/35 vs.	07980 1	Half cylinder	silver	4	10
TI12ST 10/40 vs.	80903 3	Half cylinder	silver	4	10
TI14ST 28/34 vs.	06795 2	Double cylinder	silver	4	10
TI14ST 30/30 vs.	06796 9	Double cylinder	silver	4	10
TI14ST 30/35 vs.	06805 8	Double cylinder	silver	4	10
TI14ST 30/40 vs.	06831 7	Double cylinder	silver	4	10
TI14ST 30/45 vs.	06839 3	Double cylinder	silver	4	10
TI14ST 30/50 vs.	06848 5	Double cylinder	silver	4	10
TI14ST 30/55 vs.	79293 9	Double cylinder	silver	4	10
TI14ST 30/60 vs.	79294 6	Double cylinder	silver	4	10
TI14ST 35/35 vs.	06855 3	Double cylinder	silver	4	10
TI14ST 35/40 vs.	06909 3	Double cylinder	silver	4	10
TI14ST 35/45 vs.	06915 4	Double cylinder	silver	4	10
TI14ST 35/50 vs.	06920 8	Double cylinder	silver	4	10
TI14ST 35/55 vs.	06921 5	Double cylinder	silver	4	10
TI14ST 35/60 vs.	79295 3	Double cylinder	silver	4	10
TI14ST 40/40 vs.	06923 9	Double cylinder	silver	4	10
TI14ST 40/45 vs.	06939 0	Double cylinder	silver	4	10

Ref. No. Référence Referencia	EAN 4003318	Version Exécution Versión	Finish Coloris Color	Level Degré Nível	Box Quantity Unité d'emballage Cantidad de cajas
T114ST 40/50 vs.	06940 6	Double cylinder	silver	4	10
T114ST 40/55 vs.	79296 0	Double cylinder	silver	4	10
T114ST 40/60 vs.	79297 7	Double cylinder	silver	4	10
T114ST 45/45 vs.	06941 3	Double cylinder	silver	4	10
T114ST 45/50 vs.	06942 0	Double cylinder	silver	4	10
T114ST 45/55 vs.	79298 4	Double cylinder	silver	4	10
T114ST 45/60 vs.	79299 1	Double cylinder	silver	4	10
Knob assembly set KT114 30mm	80943 9		silver	4	10
Knob assembly set KT114 35mm	80944 6		silver	4	10
Knob assembly set KT114 40mm	80945 3		silver	4	10
Knob assembly set KT114 45mm	80946 0		silver	4	10
Knob assembly set KT114 50mm	80947 7		silver	4	10
Key Blank T112, T114	05523 2		nickel plated	4	50

# TITALIUM COLOR LINE

---

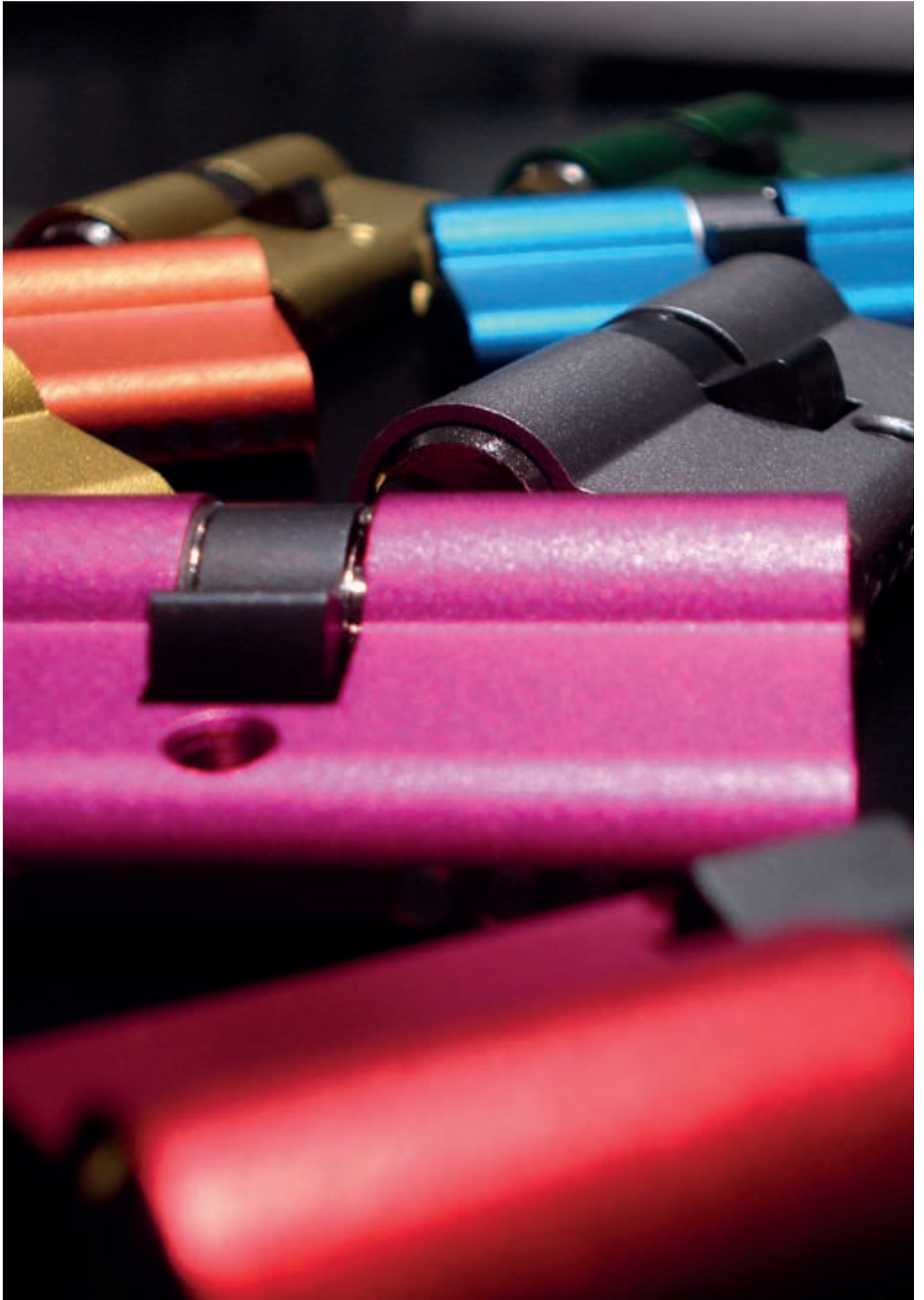

# A93

## DOOR CYLINDER WITH EMERGENCY FEATURE OR FREE-TURNING, ANTI-DRILL PROTECTION AND CONVENTIONAL KEY

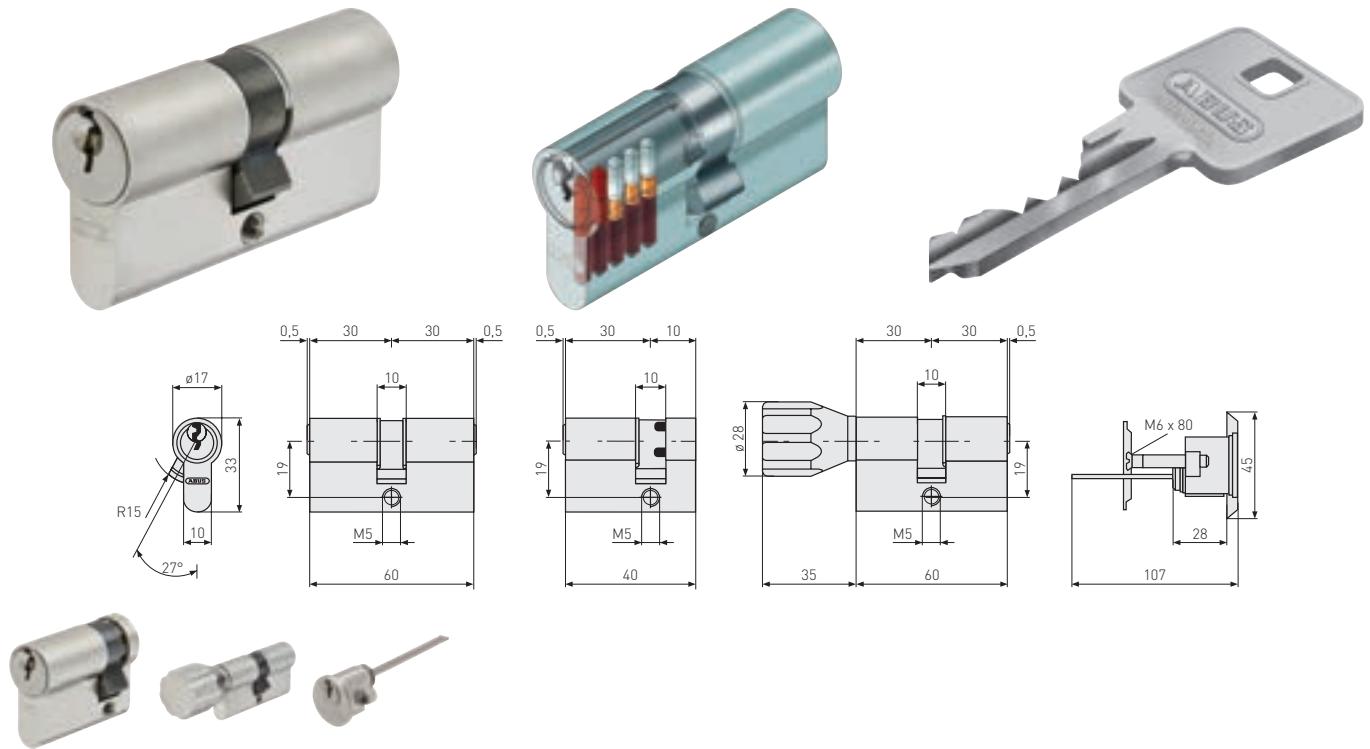

### TECHNOLOGY AND FEATURES

- DIN EN 1303 and DIN18252 tested; ISO 9001:2008
- Emergency feature (The cylinder can be operated from the outside even when a key is already inserted on the inside)
- Free-turning function (suitable for FZG tested doors)
- Tested application in RC2 doors (in combination with a suitable door fitting)
- Anti-drill protection by hardened steel pins
- 5 pin cylinder
- 11mm long key neck (perfect for door fittings with pulling protection)
- Incl. three coded keys
- ABUS Global Protection Standard (GPS) 6

### CARACTÉRISTIQUES TECHNIQUES

- DIN EN 1303 et DIN 18252 - contrôlées ; ISO 9001:2008
- Débrayable (ouverture de l'extérieur même lorsqu'une clé est introduite à l'intérieur)
- Fonction roue libre disponible en option (convient pour les portes contrôlées FZG)
- Avec protection anti-perçage par goupilles en acier cémentées
- cylindre à 5 pistons
- Col de clé de 11 mm (parfait pour les garnitures avec protection contre l'arrachement)
- avec 3 clés codifiées
- ABUS Global Protection Standard (GPS) 6

### CARACTERÍSTICAS TÉCNICAS

- Probado según DIN EN 1303 y DIN 18252; ISO 9001:2008
- Con doble embrague
- Función de apertura libre disponible de forma opcional; adecuada para puertas probadas para FZG (cilindros de apertura libre para cerraduras de engranaje)
- Protegido contra taladro
- Cilindro de 5 pernos
- Broma de la llave de 11 mm de largo (ideal para herrajes de protección contra extracciones)
- Con 3 llaves codificadas
- ABUS Global Protection Standard (GPS) 6

Ref. No. Référence Referencia	EAN 4003318	Version Exécution Versión	Finish Coloris Color	Level Degré Nível	Box Quantity Unité d'emballage Cantidad de cajas
A93NP 10/30 vs.	86149 9	Half cylinder	Nickel Pearl	6	10
A93NP 10/45 vs.	86152 9	Half cylinder	Nickel Pearl	6	10
A93NP 10/55 vs.	86154 3	Half cylinder	Nickel Pearl	6	10
A93NP 10/60 vs.	86155 0	Half cylinder	Nickel Pearl	6	10
A93NP NG 28/34 vs.	86162 8	Double cylinder	Nickel Pearl	6	10
A93NP NG 28/40 vs.	86164 2	Double cylinder	Nickel Pearl	6	10
A93NP NG 28/45 vs.	88317 0	Double cylinder	Nickel Pearl	6	10
A93NP NG 30/30 vs.	86145 1	Double cylinder	Nickel Pearl	6	10
A93NP NG 30/35 vs.	86147 5	Double cylinder	Nickel Pearl	6	10
A93NP NG 30/40 vs.	86148 2	Double cylinder	Nickel Pearl	6	10
A93NP NG 30/45 vs.	86176 5	Double cylinder	Nickel Pearl	6	10
A93NP NG 30/50 vs.	86178 9	Double cylinder	Nickel Pearl	6	10
A93NP NG 30/55 vs.	86181 9	Double cylinder	Nickel Pearl	6	10
A93NP NG 30/60 vs.	86184 0	Double cylinder	Nickel Pearl	6	10
A93NP NG 30/65 vs.	86188 8	Double cylinder	Nickel Pearl	6	10
A93NP NG 30/70 vs.	86193 2	Double cylinder	Nickel Pearl	6	10
A93NP NG 35/35 vs.	86175 8	Double cylinder	Nickel Pearl	6	10
A93NP NG 35/40 vs.	86177 2	Double cylinder	Nickel Pearl	6	10
A93NP NG 35/45 vs.	86179 6	Double cylinder	Nickel Pearl	6	10

Ref. No. Référence Referencia	EAN 4003318	Version Exécution Versión	Finish Coloris Color	Level Degré Nivel	Box Quantity Unité d'emballage Cantidad de cajas
A93NP NG 35/50 vs.	861826	Double cylinder	Nickel Pearl	6	10
A93NP NG 35/55 vs.	86185 7	Double cylinder	Nickel Pearl	6	10
A93NP NG 35/60 vs.	86189 5	Double cylinder	Nickel Pearl	6	10
A93NP NG 35/65 vs.	86194 9	Double cylinder	Nickel Pearl	6	10
A93NP NG 35/70 vs.	86199 4	Double cylinder	Nickel Pearl	6	10
A93NP NG 35/75 vs.	86204 5	Double cylinder	Nickel Pearl	6	10
A93NP NG 35/80 vs.	86210 6	Double cylinder	Nickel Pearl	6	10
A93NP NG 35/85 vs.	87995 1	Double cylinder	Nickel Pearl	6	10
A93NP NG 40/40 vs.	86180 2	Double cylinder	Nickel Pearl	6	10
A93NP NG 40/45 vs.	86183 3	Double cylinder	Nickel Pearl	6	10
A93NP NG 40/50 vs.	86186 4	Double cylinder	Nickel Pearl	6	10
A93NP NG 40/55 vs.	86191 8	Double cylinder	Nickel Pearl	6	10
A93NP NG 40/60 vs.	86195 6	Double cylinder	Nickel Pearl	6	10
A93NP NG 40/65 vs.	86200 7	Double cylinder	Nickel Pearl	6	10
A93NP NG 40/70 vs.	86205 2	Double cylinder	Nickel Pearl	6	10
A93NP NG 40/75 vs.	86211 3	Double cylinder	Nickel Pearl	6	10
A93NP NG 40/80 vs.	86216 8	Double cylinder	Nickel Pearl	6	10
A93NP NG 45/45 vs.	86187 1	Double cylinder	Nickel Pearl	6	10
A93NP NG 45/50 vs.	86192 5	Double cylinder	Nickel Pearl	6	10
A93NP NG 45/55 vs.	86196 3	Double cylinder	Nickel Pearl	6	10
A93NP NG 45/60 vs.	86201 4	Double cylinder	Nickel Pearl	6	10
A93NP NG 45/65 vs.	86206 9	Double cylinder	Nickel Pearl	6	10
A93NP NG 45/70 vs.	86212 0	Double cylinder	Nickel Pearl	6	10
A93NP NG 45/75 vs.	86217 5	Double cylinder	Nickel Pearl	6	10
A93NP NG 45/80 vs.	86221 2	Double cylinder	Nickel Pearl	6	10
A93NP NG 45/85 vs.	88004 9	Double cylinder	Nickel Pearl	6	10
A93NP NG 45/90 vs.	88005 6	Double cylinder	Nickel Pearl	6	10
A93NP NG 50/50 vs.	86197 0	Double cylinder	Nickel Pearl	6	10
A93NP NG 50/55 vs.	86202 1	Double cylinder	Nickel Pearl	6	10
A93NP NG 50/60 vs.	86207 6	Double cylinder	Nickel Pearl	6	10
A93NP NG 50/65 vs.	86213 7	Double cylinder	Nickel Pearl	6	10
A93NP NG 50/70 vs.	86218 2	Double cylinder	Nickel Pearl	6	10
A93NP NG 55/55 vs.	86208 3	Double cylinder	Nickel Pearl	6	10
A93NP NG 55/60 vs.	86214 4	Double cylinder	Nickel Pearl	6	10
A93NP NG 60/60 vs.	86220 5	Double cylinder	Nickel Pearl	6	10
A93KNP Z30/K30 vs.	86309 7	Knob cylinder	Nickel Pearl	6	1
A93KNP Z30/K35 vs.	86310 3	Knob cylinder	Nickel Pearl	6	1
A93KNP Z30/K40 vs.	86311 0	Knob cylinder	Nickel Pearl	6	1
A93KNP Z40/K55 vs.	86335 6	Knob cylinder	Nickel Pearl	6	1
A93KNP Z45/K35 vs.	86340 0	Knob cylinder	Nickel Pearl	6	1
A93KNP Z50/K35 vs.	86349 3	Knob cylinder	Nickel Pearl	6	1
A93KNP Z55/K40 vs.	86359 2	Knob cylinder	Nickel Pearl	6	1
A93KNP Z55/K55 vs.	86362 2	Knob cylinder	Nickel Pearl	6	1
A93KNP Z60/K30 vs.	86377 6	Knob cylinder	Nickel Pearl	6	1
A93KNP Z60/K35 vs.	86378 3	Knob cylinder	Nickel Pearl	6	1
A93KNP Z60/K45 vs.	86380 6	Knob cylinder	Nickel Pearl	6	1
A93KNP Z60/K50 vs.	86381 3	Knob cylinder	Nickel Pearl	6	1
A93KNP Z70/K35 vs.	86395 0	Knob cylinder	Nickel Pearl	6	1
Knob assembly set A93K 30mm	87625 7		Nickel Pearl		10
Knob assembly set A93K 34mm	88222 7		Nickel Pearl		10
Knob assembly set A93K 35mm	87626 4		Nickel Pearl		10
Knob assembly set A93K 40mm	87627 1		Nickel Pearl		10
Knob assembly set A93K 45mm	87628 8		Nickel Pearl		10
Knob assembly set A93K 50mm	87629 5		Nickel Pearl		10

## DOOR CYLINDER WITH DRILL PROTECTION AND REVERSIBLE KEY

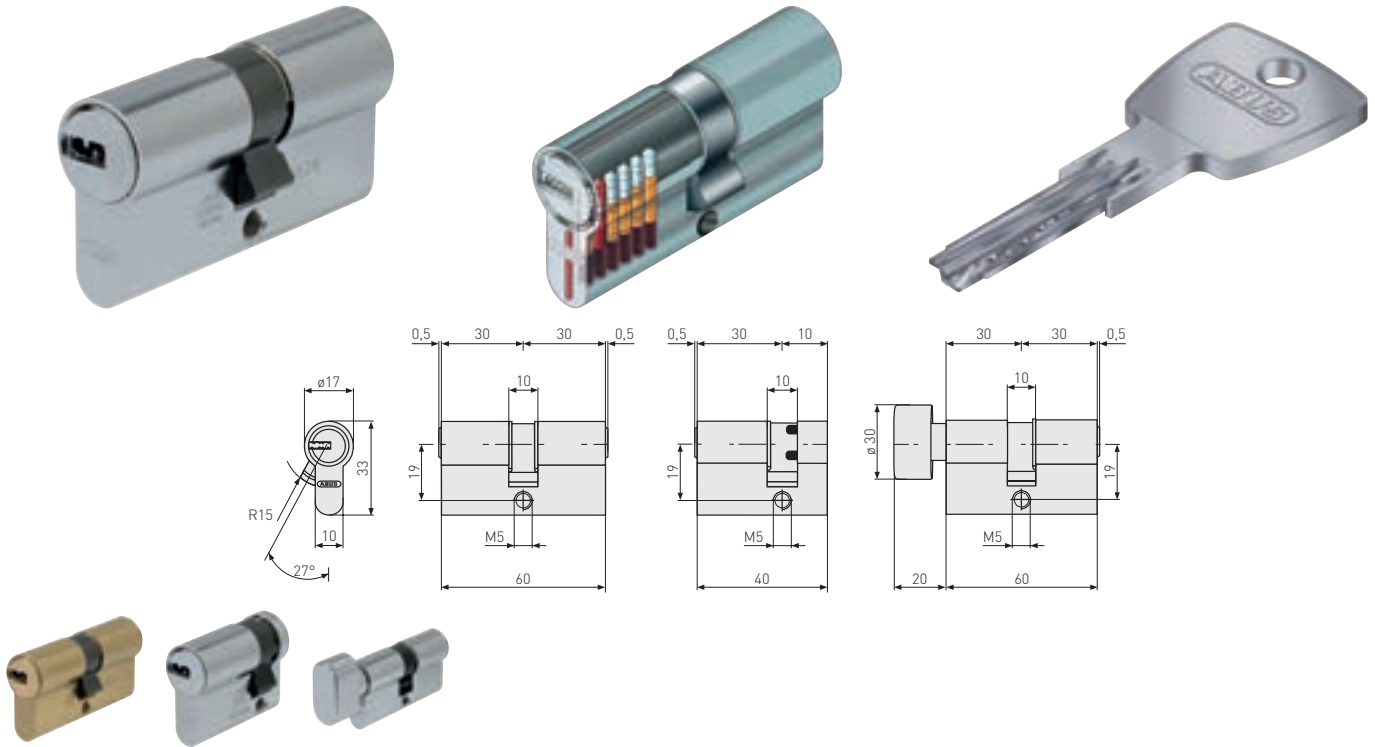

### TECHNOLOGY AND FEATURES

- Complies with DIN EN 1303, DIN 18252, ISO 9001:2008
- Drill protection due to upstream steel pins in the housing
- Mushroom-head top pins provide increased protection against picking and manipulation attempts
- Key with dimples / reversible key (no more sharp-edged incisions)
- 6-pin cylinder
- Five coded keys included
- ABUS Global Protection Standard (GPS) 6

### CARACTÉRISTIQUES TECHNIQUES

- Conforme aux normes DIN EN 1303, DIN 18252, ISO 9001:2008
- Protection anti-perçage grâce à des tiges en acier situées à l'avant du boîtier
- Les broches du boîtier en forme de champignon assurent une résistance accrue aux tentatives de picking et de manipulation
- Clé de perçage / clé réversible (plus d'entailles à arêtes vives)
- Cylindre à 6 pistons
- Cinq clés codifiées incluses
- ABUS Global Protection Standard (GPS) 6

### CARACTERÍSTICAS TÉCNICAS

- Cumple las normas DIN EN 1303, DIN 18252, ISO 9001:2008
- Protección antitaladro con pernos de acero en la carcasa
- Los pernos de cabeza de hongo proporcionan mayor resistencia a los intentos de manipulación y forzado
- Llave reversible/de puntos (ahora, sin muescas angulosas)
- Cilindro de 6 pernos
- Se incluyen cinco llaves codificadas
- ABUS Global Protection Standard (GPS) 6

Ref. No. Référence Referencia	EAN 4003318	Version Exécution Versión	Finish Coloris Color	Level Degré Nível	Box Quantity Unité d'emballage Cantidad de cajas
D6N 10/30 Basic big key	69050 1	Half cylinder	satin nickel plated	6	10
D6N 10/35 Basic big key	69098 3	Half cylinder	satin nickel plated	6	10
D6N 10/40 Basic big key	69100 3	Half cylinder	satin nickel plated	6	10
D6N 10/45 Basic big key	69101 0	Half cylinder	satin nickel plated	6	10
D6N 10/50 Basic big key	69102 7	Half cylinder	satin nickel plated	6	10
D6N 10/60 Basic big key	69103 4	Half cylinder	satin nickel plated	6	10
D6N 30/30 Basic big key	81588 1	Double cylinder	satin nickel plated	6	10
D6N 30/35 Basic big key	69408 0	Double cylinder	satin nickel plated	6	10
D6N 30/40 Basic big key	81589 8	Double cylinder	satin nickel plated	6	10
D6N 30/45 Basic big key	69409 7	Double cylinder	satin nickel plated	6	10
D6N 30/50 Basic big key	67233 0	Double cylinder	satin nickel plated	6	10
D6N 30/55 Basic big key	69410 3	Double cylinder	satin nickel plated	6	10
D6N 30/60 Basic big key	69411 0	Double cylinder	satin nickel plated	6	10
D6N 30/70 Basic big key	69412 7	Double cylinder	satin nickel plated	6	10
D6N 35/35 Basic big key	81590 4	Double cylinder	satin nickel plated	6	10
D6N 35/40 Basic big key	69413 4	Double cylinder	satin nickel plated	6	10
D6N 35/45 Basic big key	81591 1	Double cylinder	satin nickel plated	6	10
D6N 35/50 Basic big key	69414 1	Double cylinder	satin nickel plated	6	10
D6N 35/55 Basic big key	67234 7	Double cylinder	satin nickel plated	6	10

Ref. No. Référence Referencia	EAN 4003318	Version Exécution Versión	Finish Coloris Color	Level Degré Nivel	Box Quantity Unité d'emballage Cantidad de cajas
D6N 35/65 Basic big key	69415 8	Double cylinder	satín nickel plated	6	10
D6N 40/40 Basic big key	81592 8	Double cylinder	satín nickel plated	6	10
D6N 40/45 Basic big key	69417 2	Double cylinder	satín nickel plated	6	10
D6N 40/50 Basic big key	81593 5	Double cylinder	satín nickel plated	6	10
D6N 40/60 Basic big key	69419 6	Double cylinder	satín nickel plated	6	10
D6N 45/45 Basic big key	81594 2	Double cylinder	satín nickel plated	6	10
D6N 45/50 Basic big key	69422 6	Double cylinder	satín nickel plated	6	10
D6N 45/55 Basic big key	81595 9	Double cylinder	satín nickel plated	6	10
D6N 50/50 Basic big key	69424 0	Double cylinder	satín nickel plated	6	10
D6N 50/60 Basic big key	81596 6	Double cylinder	satín nickel plated	6	10
KD6N Z30/K30 Basic big key	81607 9	Knob cylinder	satín nickel plated	6	10
KD6N Z30/K40 Basic big key	81608 6	Knob cylinder	satín nickel plated	6	10
KD6N Z35/K45 Basic big key	81610 9	Knob cylinder	satín nickel plated	6	10
KD6N Z40/K30 Basic big key	69431 8	Knob cylinder	satín nickel plated	6	10
KD6N Z40/K50 Basic big key	81613 0	Knob cylinder	satín nickel plated	6	10
KD6N Z45/K35 Basic big key	81612 3	Knob cylinder	satín nickel plated	6	10
KD6N Z45/K45 Basic big key	81614 7	Knob cylinder	satín nickel plated	6	10
KD6N Z45/K55 Basic big key	81616 1	Knob cylinder	satín nickel plated	6	10
KD6N Z50/K40 Basic big key	81615 4	Knob cylinder	satín nickel plated	6	10
KD6N Z50/K50 Basic big key	81617 8	Knob cylinder	satín nickel plated	6	10
KD6N Z50/K60 Basic big key	81619 2	Knob cylinder	satín nickel plated	6	10
KD6N Z55/K45 Basic big key	81618 5	Knob cylinder	satín nickel plated	6	10
KD6N Z55/K55 Basic big key	81620 8	Knob cylinder	satín nickel plated	6	10
KD6N Z60/K50 Basic big key	81621 5	Knob cylinder	satín nickel plated	6	10
D6MM 30/30 Basic big key	81548 5		matt brass	6	10
D6MM 30/40 Basic big key	81551 5		matt brass	6	10
D6MM 30/50 Basic big key	69433 2		matt brass	6	10
D6MM 30/60 Basic big key	69434 9		matt brass	6	10
D6MM 35/35 Basic big key	81552 2		matt brass	6	10
D6MM 35/45 Basic big key	81553 9		matt brass	6	10
D6MM 40/40 Basic big key	81554 6		matt brass	6	10
D6MM 40/50 Basic big key	81556 0		matt brass	6	10
D6MM 45/45 Basic big key	81557 7		matt brass	6	10
KD6MM Z30/K30 Basic big key	81597 3		matt brass	6	10
KD6MM Z30/K40 Basic big key	81598 0		matt brass	6	10
KD6MM Z35/K35 Basic big key	81599 7		matt brass	6	10
KD6MM Z35/K45 Basic big key	81600 0		matt brass	6	10
KD6MM Z40/K40 Basic big key	81601 7		matt brass	6	10
KD6MM Z40/K50 Basic big key	81603 1		matt brass	6	10
KD6MM Z45/K35 Basic big key	81602 4		matt brass	6	10
KD6MM Z45/K45 Basic big key	81604 8		matt brass	6	10
KD6MM Z50/K40 Basic big key	81605 5		matt brass	6	10
KD6MM Z50/K50 Basic big key	81606 2		matt brass	6	10
Knob assembly set KD6PSN 30mm	78923 6		satín nickel plated		10
Knob assembly set KD6PSN 35mm	78924 3		satín nickel plated		10
Knob assembly set KD6PSN 40mm	78925 0		satín nickel plated		10
Knob assembly set KD6PSN 45mm	78926 7		satín nickel plated		10
Knob assembly set KD6PSN 50mm	78927 4		satín nickel plated		10
Knob assembly set KD6PSMM 30mm	79576 3		matt brass		10
Knob assembly set KD6PSMM 35mm	79577 0		matt brass		10
Knob assembly set KD6PSMM 40mm	79578 7		matt brass		10
Knob assembly set KD6PSMM 45mm	79579 4		matt brass		10
Knob assembly set KD6PSMM 50mm	79580 0		matt brass		10
Key blank D6 Basic big key	83104 1		satín nickel plated		50



# D10PS

## DOOR CYLINDER WITH PREDETERMINED BREAKING POINT (PRE-SNAP), EMERGENCY FEATURE AND REVERSIBLE KEY

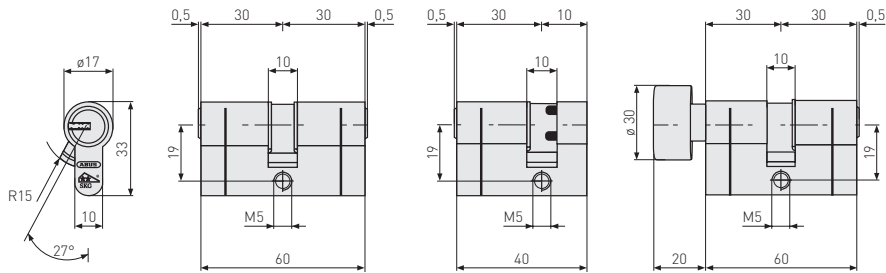
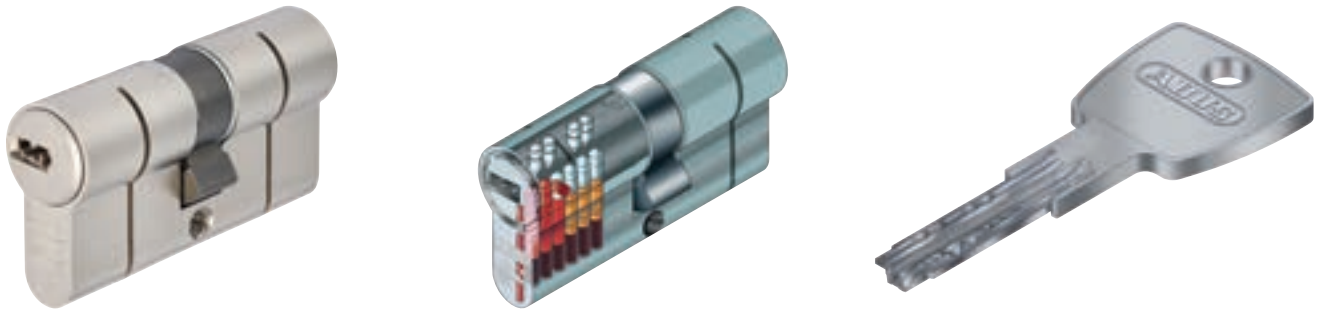

### TECHNOLOGY AND FEATURES

- Manufactured according to DIN EN 1303, DIN18252, ISO 9001:2008
- Emergency feature: The cylinder can be operated from the outside even when a key is already inserted on the inside
- Pre-snap feature (predetermined breaking point)
- 10 locking elements in 2 independent rows of pins
- Anti-drill protection as per SKG\*\* standards
- Anti-picking pins
- Dimple / Reversible key, no sharp edges and can be inserted either way up
- Code Card: additional cylinders and spare keys can be produced according to their respective code number
- Incl. five coded keys
- ABUS Global Protection Standard (GPS) 7

### CARACTÉRISTIQUES TECHNIQUES

- Fabriqué selon la DIN EN 1303, DIN 18252, ISO 9001:2008
- Débrayable: ouverture de l'extérieur même lorsqu'une clé est introduite à l'intérieur
- Avec système anti-effraction (Pre-Snap)
- 10 éléments de fermetures par côté
- Avec protection anti-perçage par goupilles en acier cémentées
- Pistons à tête de champignon
- Clé à micro-points, réversible, sans pointes aiguës
- Avec carte de reproduction
- avec 5 clés codifiées
- ABUS Global Protection Standard (GPS) 7

### CARACTERÍSTICAS TÉCNICAS

- Fabricado de acuerdo a DIN EN 1303, DIN 18252, ISO 9001:2008
- Con doble embrague
- Puntos de rotura predefinidos (Pre-Snap)
- 10 elementos de bloqueo distribuidos en 2 filas independientes de pines
- Protegido contra taladro
- Pitones anti-ganzua
- Llave reversible
- Con tarjeta codificada
- Con 5 llaves codificadas
- ABUS Global Protection Standard (GPS) 7

Ref. No. Référence Referencia	EAN 4003318	Version Exécution Versión	Finish Coloris Color	Level Degré Nível	Box Quantity Unité d'emballage Cantidad de cajas
D10PSNP 10/30 H-BOX big key	89972 0	Half cylinder	nickel pearl	7	5
D10PSNP 10/40 H-Box big key	61442 2	Half cylinder	nickel pearl	7	5
D10PSNP 30/30 H-BOX big key	39971 8	Double cylinder	nickel pearl	7	5
D10PSNP 30/35 H-BOX big key	39972 5	Double cylinder	nickel pearl	7	5
D10PSNP 30/40 H-BOX big key	61449 1	Double cylinder	nickel pearl	7	5
D10PSNP 30/45 H-BOX big key	61446 0	Double cylinder	nickel pearl	7	5
D10PSNP 30/60 H-BOX big key	61448 4	Double cylinder	nickel pearl	7	5
D10PSNP 30/70 H-BOX big key	61450 7	Double cylinder	nickel pearl	7	5
D10PSNP 35/35 H-BOX big key	39345 7	Double cylinder	nickel pearl	7	5
D10PSNP 35/40 H-BOX big key	61452 1	Double cylinder	nickel pearl	7	5
D10PSNP 35/45 H-BOX big key	61453 8	Double cylinder	nickel pearl	7	5
D10PSNP 35/55 H-BOX big key	61454 5	Double cylinder	nickel pearl	7	5
D10PSNP 35/60 H-BOX big key	39340 2	Double cylinder	nickel pearl	7	5
D10PSNP 35/65 H-BOX big key	39346 4	Double cylinder	nickel pearl	7	5
D10PSNP 40/40 H-BOX big key	39347 1	Double cylinder	nickel pearl	7	5
D10PSNP 40/45 H-BOX big key	39348 8	Double cylinder	nickel pearl	7	5
D10PSNP 40/50 H-BOX big key	39349 5	Double cylinder	nickel pearl	7	5
D10PSNP 40/55 H-BOX big key	39350 1	Double cylinder	nickel pearl	7	5
D10PSNP 40/60 H-BOX big key	39351 8	Double cylinder	nickel pearl	7	5

Ref. No. Référence Referencia	EAN 4003318	Version Exécution Versión	Finish Coloris Color	Level Degré Nível	Box Quantity Unité d'emballage Cantidad de cajas
D10PSNP 45/45 H-BOX big key	39352 5	Double cylinder	nickel pearl	7	5
D10PSNP 45/50 H-BOX big key	39353 2	Double cylinder	nickel pearl	7	5
D10PSNP 45/55 H-BOX big key	39354 9	Double cylinder	nickel pearl	7	5
D10PSNP 50/50 H-BOX big key	39355 6	Double cylinder	nickel pearl	7	5
KD10PSNP Z30/K30 H-Box big key	39357 0	Knob cylinder	nickel pearl	7	5
KD10PSNP Z30/K40 H-Box big key	39358 7	Knob cylinder	nickel pearl	7	5
KD10PSNP Z40/K30 H-Box big key	39359 4	Knob cylinder	nickel pearl	7	5
KD10PSNP Z40/K40 H-Box big key	39360 0	Knob cylinder	nickel pearl	7	5
Knob assembly set KD10/KD20 NP 30mm	54236 7		nickel pearl		10
Knob assembly set KD10/KD20 NP 35mm	54237 4		nickel pearl		10
Knob assembly set KD10/KD20 NP 40mm	54238 1		nickel pearl		10
Knob assembly set KD10/KD20 NP 45mm	54239 8		nickel pearl		10
Knob assembly set KD10/KD20 NP 50mm	54240 4		nickel pearl		10
Key Blank D10PS	83104 1		nickel plated		50



## QUALITY "MADE IN GERMANY"

As a specialist for master key systems in the ABUS Group, ABUS Pfaffenhain develops high-quality, innovative locking systems at its location in Jahnsdorf.

The production takes place consistently from the cylinder housing to the core pin "Made in Germany". In this way we guarantee the highest product quality.

## CUSTOM-MADE SOLUTIONS

From a single-family house to a building complex: We offer single locks as well as small to very large master key systems and offer you the optimal solution for every security requirement. ABUS locking systems can be expanded at any time so that you can react flexibly to changes in the building structure.

Of course, you will also receive additional products for your locking system many years after the first order.

# OVERVIEW

THE RIGHT CYLINDER FOR EVERY USE

## EURO PROFILE CYLINDERS



## RIM CYLINDERS

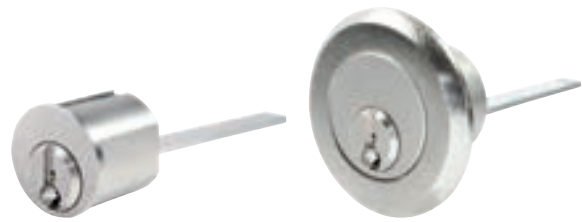

## MORTICE CYLINDERS



## SPECIAL CYLINDERS



## CAM CYLINDERS



## OVAL CYLINDERS



## LIFT CYLINDERS



## LOCKING INSERTS

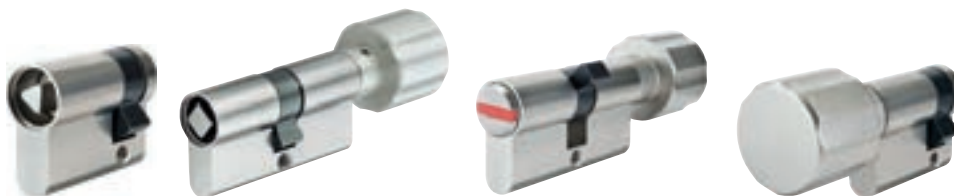

## PADLOCKS



# AS INDIVIDUAL AS YOUR PROPERTY

## TYPES OF MASTER KEY SYSTEMS

### KEYED ALIKE

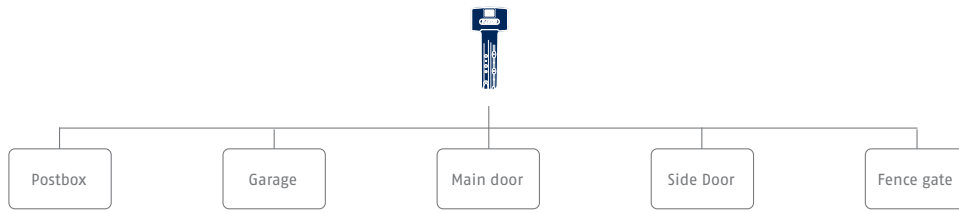

### CENTRAL KEYED SYSTEMS FOR APARTMENT BUILDINGS

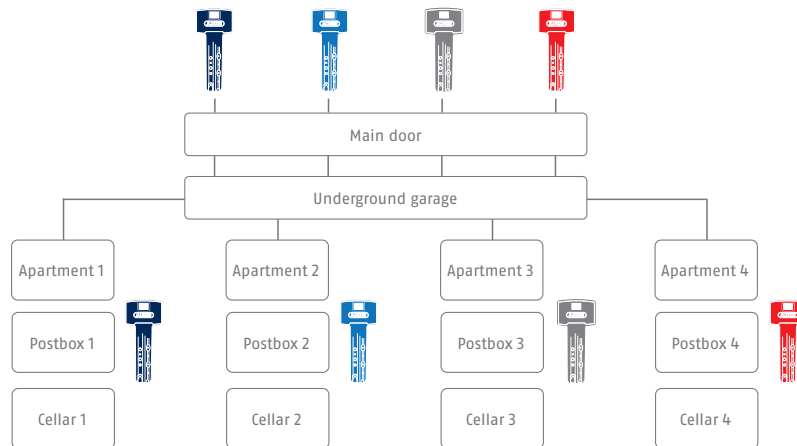

### MASTERKEYED SYSTEMS FOR THE EDUCATION SECTOR

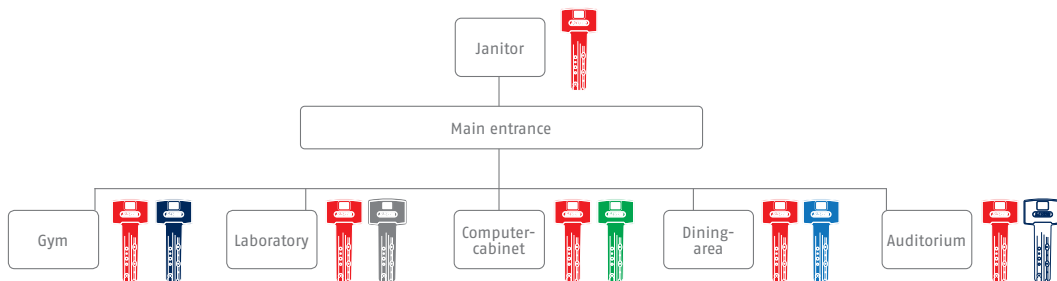

### GRAND MASTERKEYED SOLUTIONS FOR COMMERCIAL & PUBLIC APPLICATIONS

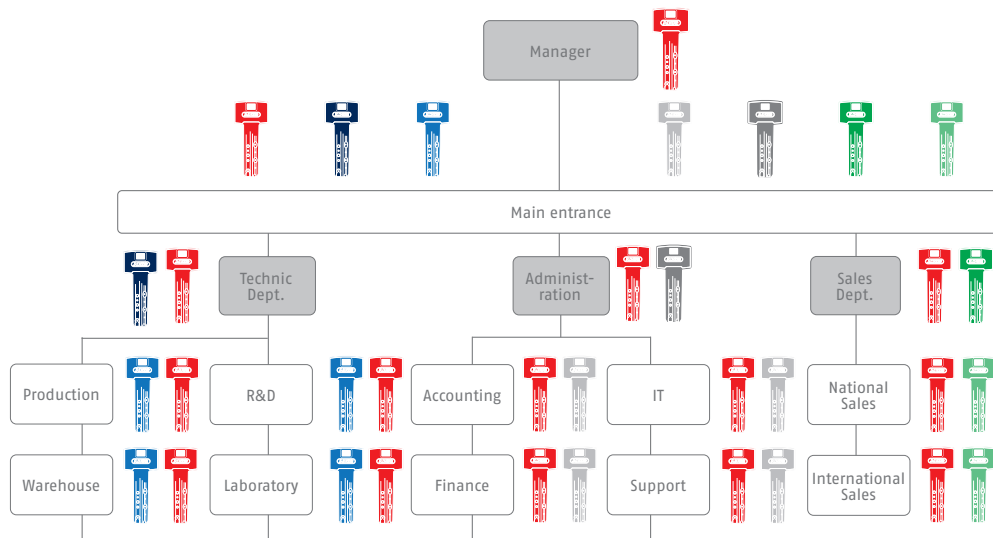

# BRAVUS MX MAGNET

---



## HIGH-END SECURITY

The Bravus MX Magnet offers the highest level of security – thanks to the integrated magnet technology, SKG\*\*\* security certification as standard, technical copy protection, patent protection until 2038\* and trademark protection. The independent SKG testing institute has certified the Bravus MX magnetic Euro profile cylinders in the highest security class, SKG\*\*\*. The magnetic cylinder also achieves the highest security level in the categories of lock security, durability, corrosion resistance, fire resistance and pick resistance.

# VITESS

---

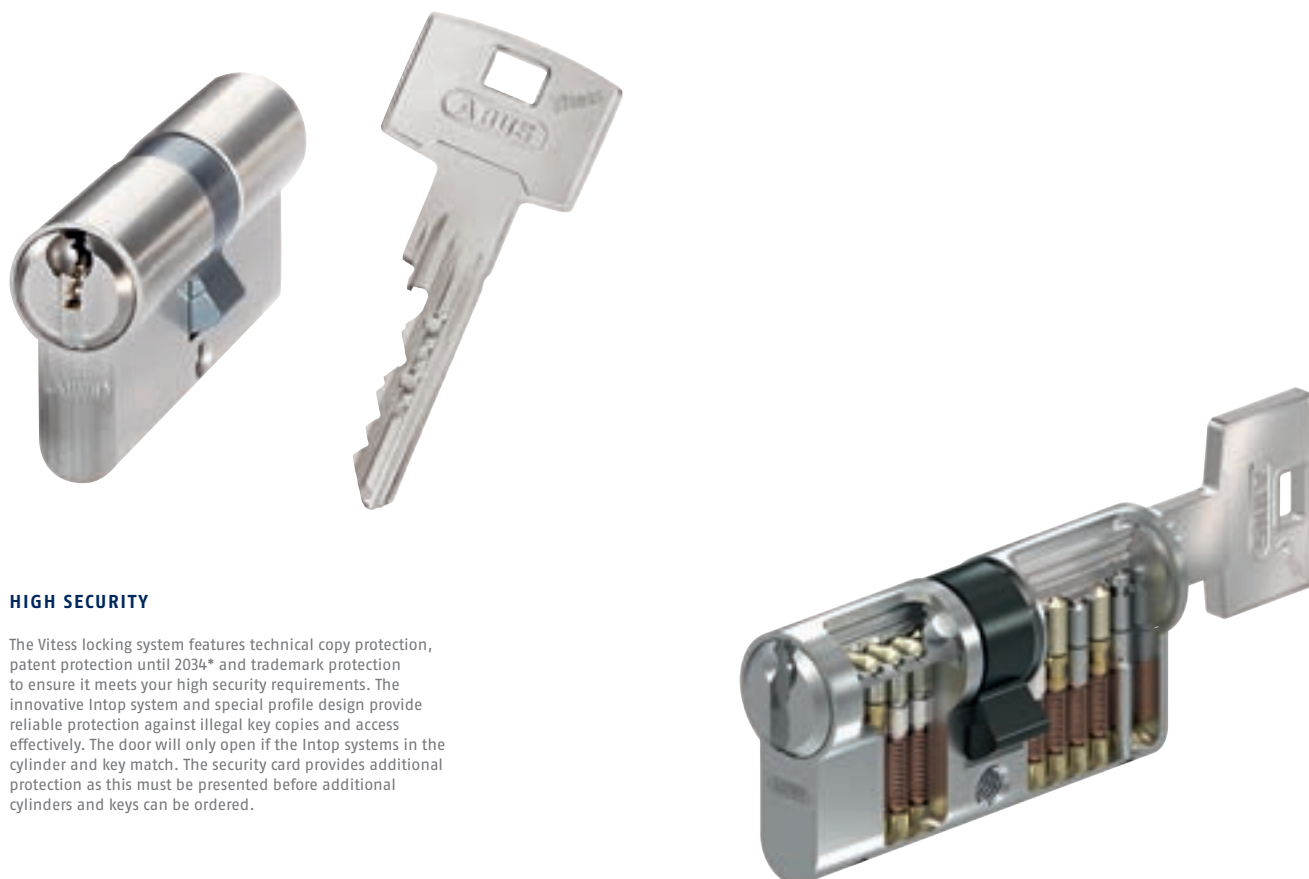

## HIGH SECURITY

The ViteSS locking system features technical copy protection, patent protection until 2034\* and trademark protection to ensure it meets your high security requirements. The innovative Intop system and special profile design provide reliable protection against illegal key copies and access effectively. The door will only open if the Intop systems in the cylinder and key match. The security card provides additional protection as this must be presented before additional cylinders and keys can be ordered.



# PR2800

## DOOR BAR IN ELEGANT SLIMLINE DESIGN

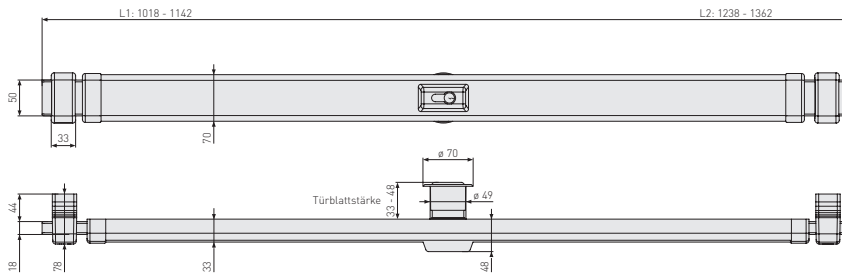

External escutcheon



External escutcheon



6N029

N 001141



### TECHNOLOGY AND FEATURES

- Secures the door over the whole width
- Telescopic tubular body for adaptation to different door widths
- Bolt with rebound protection
- For door widths from 735 - 1 200 mm
- Incl. anti-pull protected escutcheon and ABUS Pfaffenhain cylinder (30/60)
- Comfortable and quiet operation owing to the special metal drive components
- The locking direction can be changed
- Comprehensive accessories can be used
- Hardened bolt bars

### CARACTÉRISTIQUES TECHNIQUES

- Sécurise la porte sur toute sa largeur
- Tube télescopique permettant une adaptation sur différentes dimensions de vantaux
- Barre avec protection contre les retours
- Pour largeurs de vantail de 735 à 1 200 mm
- Avec rosace anti-arrachement et cylindre ABUS Pfaffenhain (30/60)
- Utilisation confortable et silencieuse grâce à des composants de fonctionnement métalliques spéciaux
- Possibilité de changer le sens de fermeture
- Utilisation possible d'accessoires complets
- Tubes du verrou renforcés

### CARACTERÍSTICAS TÉCNICAS

- Protege las puertas en toda su anchura
- Cuerpo tubular telescópico para adaptarse a puertas con diferentes anchuras de hoja
- Barra con seguro antirretorno
- Para anchos de puerta de 735 - 1200 mm
- Incl. escudo protector antiextracción y cilindro ABUS-Pfaffenhain (30/60)
- Funcionamiento cómodo y silencioso gracias a componentes de accionamiento especiales de metal
- Posibilidad de cambiar el sentido de cierre
- Amplia gama de accesorios disponible
- Barras tubulares endurecidas

Ref. No. Référence Referencia	EAN 4003318	Length mm Longueur mm Largo mm	Door width mm Batant de porte mm Anchura de puerta mm	Finish Coloris Color	Level Degré Nivel	Box Quantity Unité d'emballage Cantidad de cajas
PR2800 B L1	01699 8		735-980	brown		1
PR2800 B L1 without cylinder	01700 1		735-980	brown		1
PR2800 B L2	01704 9		980-1200	brown		1
PR2800 B L2 without cylinder	01703 2		980-1200	brown		1
PR2800 Stainless steel look L1	01711 7		735-980	Stainless steel look		1
PR2800 Stainless steel look L without cylinder	01706 3		735-980	Stainless steel look		1
PR2800 Stainless steel look L2	01713 1		980-1200	Stainless steel look		1
PR2800 Stainless steel look L2 without cylinder	01712 4		980-1200	Stainless steel look		1
PR2800 W L1	01689 9		735-980	white		1
PR2800 W L1 without cylinder	01690 5		735-980	white		1
PR2800 W L2	01696 7		980-1200	white		1
PR2800 W L2 without cylinder	01695 0		980-1200	white		1
External escutcheon PR2800 B	71160 2			brown		1
External escutcheon PR2800 ER	71161 9			Stainless steel look		1
External escutcheon PR2800 W	71163 3			white		1
External escutcheon PR2800 MS-PVD	71162 6			brass		1
PR Alarm NRS B **	85458 3			brown		1
PR Alarm NRS S **	85460 6			silver		1
PR Alarm NRS W **	85459 0			white		1



# PR2600

## DOOR BAR IN ELEGANT SLIMLINE DESIGN

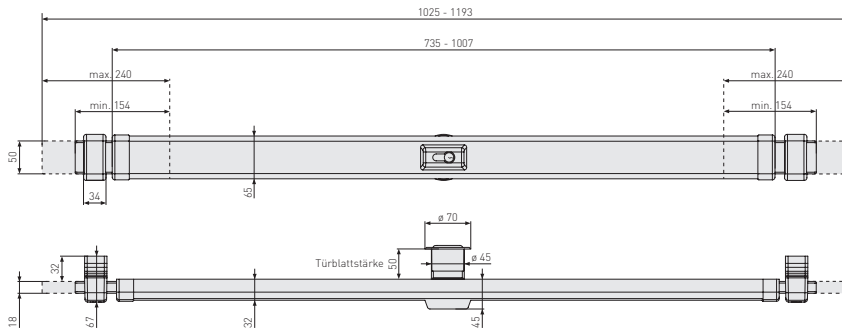

### TECHNOLOGY AND FEATURES

- Secures the door over the whole width
- Strong wall anchor: ensures maximum strength against physical attack
- For door widths from 735 - 1 030 mm
- Locks with two turns
- Cylinder can be exchanged easily to integrate the lock into master keyed systems
- ABUS cylinder EC550 inclusive (standard)
- Significant noise reduction by special drive components
- Fitting instructions and fitting materials included
- Incl. three keys

### CARACTÉRISTIQUES TECHNIQUES

- Sécurise la porte sur toute la largeur du montant
- Les deux pènes s'encastrent solidement dans les statos de verrou ancrés dans le mur
- Pour des épaisseurs de montant de 735 à 1 030 mm
- Fermeture à deux tours
- Le cylindre peut être changé afin d'intégrer le cadenas au système de fermeture
- Version standard y compris ABUS cylindre EC550
- Importante diminution des bruits grâce à des composantes spéciales de fonctionnement
- Le matériel de fixation est compris dans la livraison
- Trois clés incluses

### CARACTERÍSTICAS TÉCNICAS

- Asegura la puerta en todo el ancho
- Sólida protección contra apalancamiento: alta seguridad gracias a la alta resistencia a la torsión de las condensas tubulares rectangulares típicas de ABUS
- Se ajusta a puertas de ancho desde 735 - 1 030 mm
- Se cierra con doble vuelta
- El cilindro se puede intercambiar fácilmente y así integrar la barra dentro de un amaestramiento
- Incluye cilindro de puntos estándar EC550
- Nueva versión más silenciosa al cierre
- Instrucciones de montaje y materiales de montaje incluidos
- Suministrado con 3 llaves

Ref. No. Référence Referencia	EAN 4003318	Length Longueur Largo mm	Door width Batant de porte Anchura de puerta mm	Finish Coloris Color	Level Degré Nivel	Box Quantity Unité d'emballage Cantidad de cajas
PR2600 B	51381 7	709	735-1030	brown	8	1
PR2600 B without cylinder	51380 0	709	735-1030	brown	8	1
PR2600 W	51384 8	709	735-1030	white	8	1
PR2600 W without cylinder	51383 1	709	735-1030	white	8	1
PR Alarm NRS B *	85458 3			brown		1
PR Alarm NRS S *	85460 6			silver		1
PR Alarm NRS W *	85459 0			white		1

**SURCHARGE / MAJORATION / RECARGO  
WITHOUT CYLINDER / SANS CYLINDRE / SIN CILINDRO**

# PR1500

HIGH PROTECTION FOR BACK OR SIDE EXITS

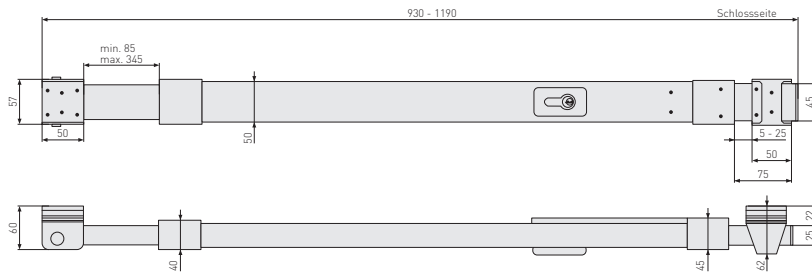

## TECHNOLOGY AND FEATURES

- Secures the door over the whole width
- Heavy duty wall anchors for maximum strength
- For door widths from 780 - 1 040 mm
- Special lengths of 1 040 - 1 440 mm are available
- ABUS cylinder EC550 inclusive (standard)
- Incl. three keys

## CARACTÉRISTIQUES TECHNIQUES

- Sécurise la porte sur toute la largeur du montant
- Haute protection contre l'effet de levier grâce à des pènes de verrouillage spéciaux
- Pour des épaisseurs de montant de 780 à 1 040 mm
- Longueurs spéciales livrables pour les épaisseurs de montant de 1 040 à 1 440 mm
- Version standard y compris ABUS cylindre EC550
- Trois clés incluses

## CARACTERÍSTICAS TÉCNICAS

- Sécurise la porte sur toute la largeur du montant
- Haute protection contre l'effet de levier grâce à des pènes de verrouillage spéciaux
- Pour des épaisseurs de montant de 780 à 1 040 mm
- Longueurs spéciales livrables pour les épaisseurs de montant de 1 040 à 1 440 mm
- Version standard y compris ABUS cylindre EC550
- Trois clés incluses

Ref. No. Référence Referencia	EAN 4003318	Length Longueur Largo mm	Door width Batant de porte Anchura de puerta mm	Finish Coloris Color	Level Degré Nivel	Box Quantity Unité d'emballage Cantidad de cajas
PR1500 S	04649 0	720	780-1040	silver	8	1

**SURCHARGE / MAJORATION / RECARGO**  
**WITHOUT CYLINDER / SANS CYLINDRE / SIN CILINDRO**

# 2110

## ELEGANT DOOR RIM LOCK

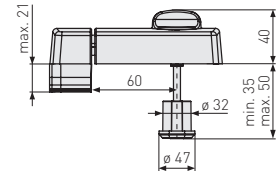
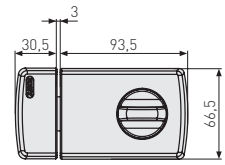

### TECHNOLOGY AND FEATURES

- Secure mounting
- Locks with two turns
- Precision 5-pin-tumbler cylinder
- With knob on the inside
- Incl. two keys

### CARACTÉRISTIQUES TECHNIQUES

- Fixation solide
- Fermeture à deux tours
- Cylindre de précision à 5 goupilles
- Avec bouton à l'intérieur et clé à l'extérieur
- Deux clés incluses

### CARACTERÍSTICAS TÉCNICAS

- Sólida fijación, Montaje simple y rápido
- Se cierra con 2 vueltas
- Cilindro de serreta de precisión de 5 pitones
- Con pomo por el interior y llave por el exterior
- Incl. dos llaves

Ref. No. Référence Referencia	EAN 4003318	Variants Exécutions Variantes	Finish Coloris Color	Level Degré Nivel	Box Quantity Unité d'emballage Cantidad de cajas
2110 B CL/DFNLI	78777 5	with turning knob	brown	5	1
2110 W CL/DFNLI	78778 2	with turning knob	white	5	1
2110 S CL/DFNLI	79112 3	with turning knob	silver	5	1

# 2130

## DOOR RIM LOCK WITH DOOR GUARD

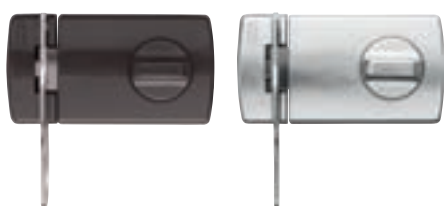
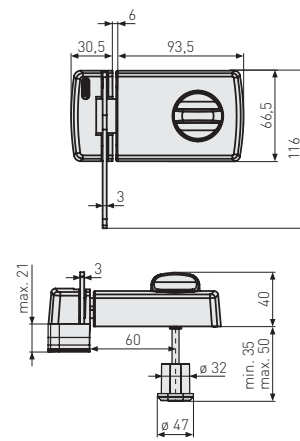

### TECHNOLOGY AND FEATURES

- Secure mounting
- Stable door guard for partial opening of the door
- Precision 5-pin-tumbler cylinder
- Locks with two turns
- With knob on the inside
- Incl. two keys

### CARACTÉRISTIQUES TECHNIQUES

- Fixation solide
- Avec entrebâilleur solide permettant l'entrebâillement de la porte en toute sécurité
- Cylindre de précision à 5 goupilles
- Fermeture à deux tours
- Avec bouton à l'intérieur et clé à l'extérieur
- Deux clés incluses

### CARACTERÍSTICAS TÉCNICAS

- Sólida fijación
- Pestillo para puerta estable para abrir solo una rendija la puerta
- Cilindro de serreta de precisión de 5 pitones
- Se cierra con 2 vueltas
- Con pomo por el interior y llave por el exterior
- Incl. dos llaves

Ref. No. Référence Referencia	EAN 4003318	Variants Exécutions Variantes	Finish Coloris Color	Level Degré Nivel	Box Quantity Unité d'emballage Cantidad de cajas
2130 B CL/DFNLI	56034	7 with door guard and turning knob	brown	6	1
2130 W CL/DFNLI	56035	4 with door guard and turning knob	white	6	1
2130 S CL/DFNLI	56036	1 with door guard and turning knob	silver	6	1

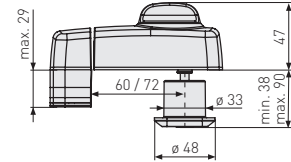
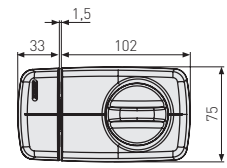

Drill Template



### TECHNOLOGY AND FEATURES

- VdS approved with Pfaffenhain cylinder KV356
- Resistant more than one ton load
- Strong wall anchoring of the striking plate with heavy duty dowels
- With two alternative thumbturns on the inside
- Two backsets can be adjusted: 60 and 72 mm
- Solid oval bolt made from solid steel, locks with two turns
- Easy to combine with Armoured Escutcheon Plate PZS4060
- With external cylinder series EC550, three keys included
- Boxed version: Lock case and striking plate made from metal
- Blister version: Lock case and striking plate made from plastic
- Option to equip with EC660 rim cylinder

### CARACTÉRISTIQUES TECHNIQUES

- Homologué VdS avec cylindre Pfaffenhain ABUS KV356
- Résistance mécanique de plus d'une tonne
- Fort ancrage mural du boîtier du verrou grâce à des douilles poids lourd
- Intérieur avec deux boutons de porte tournants alternatifs
- Deux distances aux canons réglables : 60 et 72 mm
- Pêne ovale stable tout acier avec fermeture à deux tours
- Facilement combinable avec la plaque extérieure anti-arrachement PZS70
- Version standard : livré avec la série de cylindre extérieur EC550 et trois clés
- Emballage boîte : Boîtier et gâche en métal
- Emballage blister : Boîtier et gâche en PVC
- Possibilité d'équipement avec cylindre extérieur EC660

### CARACTERÍSTICAS TÉCNICAS

- Aprobado por Vds con un cilindro KV356 ABUS Pfaffenhain
- Resiste más de 1 tonelada de carga
- Fuerte anclaje a la pared de la caja de la cerradura
- Se suministran con 2 pomos para instalar al ras o que el pomo sobresalga
- Se puede cambiar la distancia. Vienen a 72 mm para poner a 60 mm
- Cerrojo de seguridad de doble enganche, se cierra con 2 vueltas a la llave
- Fácil de combinar con la placa de protección contra tirones PZS70
- Incluye cilindro de puntos EC550, suministrado con 3 llaves
- Producto-EK: caja de cerradura de metal (MT)
- Producto-SB: caja de cerradura de plástico
- Posibilidad de equipamiento con el cilindro exterior EC660

Ref. No. Référence Referencia	EAN 4003318	Variants Exécutions Variantes	Finish Coloris Color	Level Degré Nivel	Box Quantity Unité d'emballage Cantidad de cajas
7010 B EK	53268 9	cylinder-Series EC550	brown	9	1
7010 W EK	53270 2	cylinder-Series EC550	white	9	1
7010 S EK	53269 6	cylinder-Series EC550	silver	9	1
7010 B	53304 4	without cylinder	brown	9	1
7010 W	53306 8	without cylinder	white	9	1
7010 S	53305 1	without cylinder	silver	9	1
7010 B VdS EK	53574 1	with cylinder ABUS Pfaffenhain	brown	9	1
7010 W VdS EK	53576 5	with cylinder ABUS Pfaffenhain	white	9	1
7010 S VdS EK	53575 8	with cylinder ABUS Pfaffenhain	silver	9	1
Drill Template 7000	59479 3				1

### SURCHARGE / MAJORATION / RECARGO

• GL/KA

### WITHOUT CYLINDER / SANS CYLINDRE / SIN CILINDRO

### KA AS PER SAMPLE / FERMETURE SELON ÉCHANTILLON / CIERRE SEGÚN MUESTRA

# 7030

## ELEGANT DOOR RIM LOCK WITH DOOR GUARD

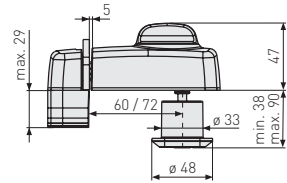
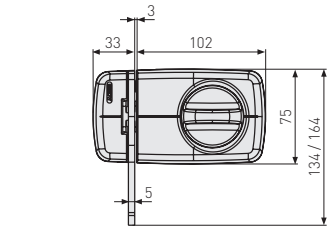

Drill Template



### TECHNOLOGY AND FEATURES

- Resists more than one ton load
- Strong wall anchoring of the striking plate with heavy duty dowels
- With two alternative thumbturns on the inside
- Two backsets can be adjusted: 60 and 72 mm
- Solid oval bolt made from solid steel, locks with two turns
- Hardened door guard for partial opening of the door
- With external cylinder series EC550, three keys included
- Boxed version: Lock case and striking plate made from metal
- Blister version: Lock case and striking plate made from plastic
- Option to equip with EC660 rim cylinder

### CARACTÉRISTIQUES TECHNIQUES

- Résistance mécanique de plus d'une tonne
- Ancrage mural solide de la gâche grâce à des douilles poids lourd
- Intérieur avec deux boutons de porte tournants alternatifs
- Deux distances aux canons réglables : 60 et 72 mm
- Pêne ovale stable tout acier avec fermeture à deux tours
- Entrebâilleur renforcé pour entrebâillement de porte
- Avec série de cylindre intérieur et extérieur EC550 (livré avec trois clés)
- Emballage boîte : Boîtier et gâche en métal
- Emballage blister : Boîtier et gâche en PVC
- Possibilité d'équipement avec cylindre extérieur EC660

### CARACTERÍSTICAS TÉCNICAS

- Resiste más de 1 tonelada de carga
- Sólida fijación
- Se suministran con 2 pomos para instalar al ras o que el pomo sobresalga
- Se puede cambiar la distancia: 60 y 72mm
- Cerrojo de seguridad de doble enganche, se cierra con 2 vueltas a la llave
- Barra de bloqueo endurecida para la apertura de la puerta de ancho total
- Incluye cilindro de puntos EC550, suministrado con 3 llaves
- Producto-EK: caja de cerradura de metal (MT)
- Producto-SB: caja de cerradura de plástico
- Posibilidad de equipamiento con el cilindro exterior EC660

Ref. No. Référence Referencia	EAN 4003318	Variants Exécutions Variantes	Finish Coloris Color	Level Degré Nivel	Box Quantity Unité d'emballage Cantidad de cajas
7030 B EK	53274 0	with door guard	brown	10	1
7030 W EK	53276 4	with door guard	white	10	1
7030 S EK	53275 7	with door guard	silver	10	1
7030 B	53307 5	without cylinder	brown	10	1
7030 W	53309 9	without cylinder	white	10	1
7030 S	53308 2	without cylinder	silver	10	1
Drill Template 7000	59479 3				1

### SURCHARGE / MAJORATION / RECARGO

- GL/KA

### WITHOUT CYLINDER / SANS CYLINDRE / SIN CILINDRO

### KA AS PER SAMPLE / FERMETURE SELON ÉCHANTILLON / CIERRE SEGÚN MUESTRA

# 7035

## ELEGANT DOOR RIM LOCK WITH DOOR GUARD

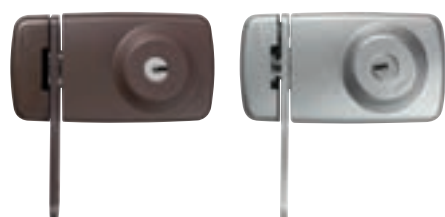
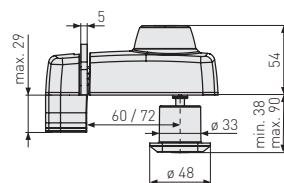
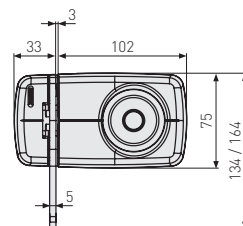

Drill Template



### TECHNOLOGY AND FEATURES

- Resists more than one ton load
- Two backsets can be adjusted: 60 and 72 mm
- Solid oval bolt made from solid steel, locks with two turns
- Hardened door guard for partial opening of the door
- With internal and external cylinder series EC550, three keys included
- Boxed version: Lock case and striking plate made from metal
- Blister version: Lock case and striking plate made from plastic
- Option to equip with EC660 cylinder set (inside and outside)

### CARACTÉRISTIQUES TECHNIQUES

- Résistance mécanique de plus d'une tonne
- Deux distances aux canons réglables : 60 et 72 mm
- Pêne ovale stable tout acier avec fermeture à deux tours
- Entrebâilleur renforcé pour entrebâillement de porte
- Avec série de cylindre intérieur et extérieur EC550 (livré avec trois clés)
- Emballage boîte : Boîtier et gâche en métal
- Emballage blister : Boîtier et gâche en PVC
- Possibilité d'équipement avec kit de cylindre EC660 (intérieur et extérieur)

### CARACTERÍSTICAS TÉCNICAS

- Resiste más de 1 tonelada de carga
- Se puede cambiar la distancia. Vienen a 72 mm para poner a 60 mm
- Cerrojo de seguridad de doble enganche, se cierra con 2 vueltas a la llave
- Barra de bloqueo endurecida para la apertura de la puerta de ancho total
- Incluye cilindro de puntos EC550, suministrado con 3 llaves
- Producto-EK: caja de cerradura de metal (MT)
- Producto-SB: caja de cerradura de plástico
- Posibilidad de equipar con juego de cilindros EC660 (interior y exterior)

Ref. No. Référence Referencia	EAN 4003318	Variants Exécutions Variantes	Finish Coloris Color	Level Degré Nivel	Box Quantity Unité d'emballage Cantidad de cajas
7035 B EK	53277 1	with door guard and inner cylinder	brown	10	1
7035 W EK	53279 5	with door guard and inner cylinder	white	10	1
7035 S EK	53278 8	with door guard and inner cylinder	silver	10	1
7035 B	53438 6	without rim cylinder	brown	10	1
7035 W	53439 3	without rim cylinder	white	10	1
7035 S	54385 2	without rim cylinder	silver	10	1
Drill Template 7000	59479 3				1

### SURCHARGE / MAJORATION / RECARGO

- GL/KA

### WITHOUT CYLINDER / SANS CYLINDRE / SIN CILINDRO

### KA AS PER SAMPLE / FERMETURE SELON ÉCHANTILLON / CIERRE SEGÚN MUESTRA

# 3630

## DOOR RIM LOCK

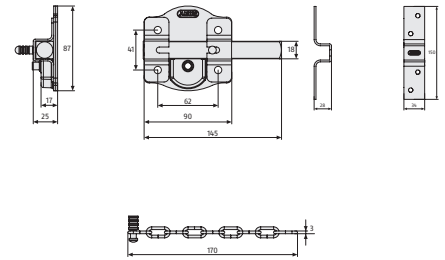
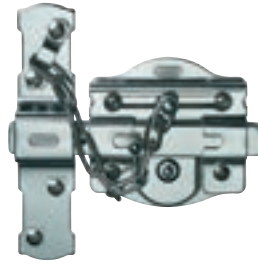

### TECHNOLOGY AND FEATURES

- Solid steel bolt
- For inwards opening entrance doors
- Lockable with rim cylinder on the outside, with sliding bolt on the inside
- Door chain to restrict opening of the door – permanent protection

### CARACTÉRISTIQUES TECHNIQUES

- Pêne de verrouillage solide
- Pour portes d'entrée avec ouverture intérieure
- Actionnement par cylindre extérieur et pêne de verrouillage à l'intérieur
- Avec chaînette de porte à l'intérieur pour une protection permanente

### CARACTERÍSTICAS TÉCNICAS

- Pasador sólido acero
- Para puertas de entrada de apertura hacia el interior
- Cierre mediante cilindro desde el exterior y pestillo desde el interior
- Cadena para apertura limitada – protección permanente

Ref. No. Référence Referencia	EAN 4003318	Version Exécution Versión	Finish Coloris Color	Level Degré Nivel	Box Quantity Unité d'emballage Cantidad de cajas
3630 50 N EK	77227 6	with rim cylinder		6	2

# SK78

## LOCKABLE DOOR CHAIN

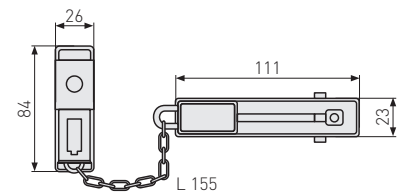

### TECHNOLOGY AND FEATURES

- Hardened chain
- Child-proof safety catch; The built-in spring within the slide rail prevents accidental opening by children
- Quality 4-pin tumbler cylinder
- Visible chain length: 15.5 cm
- Incl. two keys
- Rotating cylinder ensures easy operation

### CARACTÉRISTIQUES TECHNIQUES

- Chaîne spéciale renforcée
- Sécurité pour enfants : Le rail est équipé d'un cran d'arrêt à ressort
- Cylindre tournant de haute qualité à 4 goupilles
- Longueur de chaîne visible : 15,5 cm
- 2 clés incluses

### CARACTERÍSTICAS TÉCNICAS

- Cadena endurecida
- Seguridad para niños: el muelle en el rail evita la apertura accidental
- Mecanismo de cierre de 4 pitones
- Largura de la cadena visible: 15,5 cm
- Incl. dos llaves
- Cilindro giratorio que facilita la apertura desde el exterior



Ref. No. Référence Referencia	EAN 4003318	Version Exécution Versión	Finish Coloris Color	Level Degré Nivel	Box Quantity Unité d'emballage Cantidad de cajas
SK78 B CL/DFNLI	83601 5		brown	6	3
SK78 W CL/DFNLI	83603 9		white	6	3
SK78 S CL/DFNLI	83602 2		silver	6	3



# SK69

## TRADITIONAL DOOR CHAIN

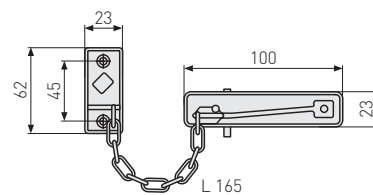

### TECHNOLOGY AND FEATURES

- Welded steel chain
- Childproof lock: spring-loaded bolt
- Integrated chain support

### CARACTÉRISTIQUES TECHNIQUES

- Chaîne soudée en acier
- Sécurité enfants : cran d'arrêt à ressort
- Fixation de chaîne intégrée

### CARACTERÍSTICAS TÉCNICAS

- Cadena de acero soldado
- Seguridad para niños: por el interior se necesitan 2 manos para liberar la cadena de su riel, gracias a un tope de plástico con muelle
- Cuando no está en uso, la cadena puede colgarse de la parte que va al marco para que no dañe la puerta



Ref. No. Référence Referencia	EAN 4003318	Version Exécution Versión	Finish Coloris Color	Level Degré Nivel	Box Quantity Unité d'emballage Cantidad de cajas
SK69 N CL/DFNLI	83609 1	lockable door chain	nickel-plated	2	3
SK69 M CL/DFNLI	01386 7	lockable door chain	brass-colored	2	3

# TAS102

## PROTECTION FOR THE HINGE SIDE OF DOORS

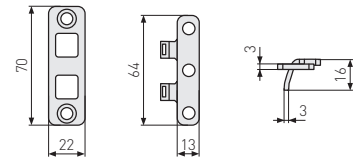

### TECHNOLOGY AND FEATURES

- Covered, in closed position invisible installation
- Two solid steel bolts with claw bolts
- Firmly fixed with door and frame

### CARACTÉRISTIQUES TECHNIQUES

- Montage masqué, invisible en position fermée
- Deux pènes acier à crochet
- Fixation solide dans la porte et le cadre

### CARACTERÍSTICAS TÉCNICAS

- En posición cerrado, la instalación es invisible
- Dos paletones de acero con enclavamiento
- Se engancha firmemente a la puerta y al marco



Ref. No. Référence Referencia	EAN 4003318	Version Exécution Versión	Finish Coloris Color	Level Degré Nivel	Box Quantity Unité d'emballage Cantidad de cajas
TAS102 EK	24535 0		Stainless Steel	6	1

# TAS82

## PROTECTION FOR THE HINGE SIDE OF DOORS

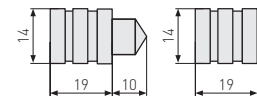

### TECHNOLOGY AND FEATURES

- Automatic function
- Always supplied and fitted in pairs

### CARACTÉRISTIQUES TECHNIQUES

- Sécurité enclenchée «automatiquement»
- Livraison et montage toujours par paire

### CARACTERÍSTICAS TÉCNICAS

- La protección siempre está preparada automáticamente



Ref. No. Référence Referencia	EAN 4003318	Version Exécution Versión	Finish Coloris Color	Level Degré Nivel	Box Quantity Unité d'emballage Cantidad de cajas
TAS82 CL/DFNLI	00624 1	Twin-pack	nickel-plated	3	6

# 2203

## DOOR VIEWER

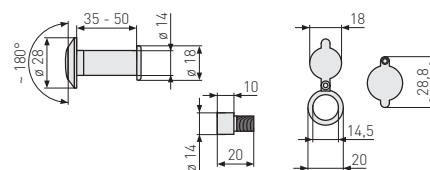

### TECHNOLOGY AND FEATURES

- Wide-angle lens of approx. 180°, you can see every corner in front of the door
- For door thicknesses of 35-106 mm
- Incl. 3 spacers
- With internal privacy cover to prevent light output
- Glass lens
- Brass housing

### CARACTÉRISTIQUES TECHNIQUES

- Vision grand angle de 180° env., possibilité de voir chaque coin devant la porte
- Pour des épaisseurs de porte de 35 à 106 mm
- Avec 3 rallonges
- Intérieur avec cache (en tôle) pour éviter l'entrée de lumière
- Lentille en verre
- Boîtier en laiton

### CARACTERÍSTICAS TÉCNICAS

- El amplio ángulo de visión de aprox. 180° permite observar todos los ángulos frente a la puerta
- Para puertas de 35 - 106 mm de grosor
- Se incluyen 3 separadores
- Con cubierta de privacidad en la parte interior para evitar la entrada de luz
- Lente de cristal
- Carcasa de latón

Ref. No. Référence Referencia	EAN 4003318	Variants Exécutions Variantes	Finish Coloris Color	Level Degré Nivel	Box Quantity Unité d'emballage Cantidad de cajas
2203 S	78811 6	with privacy cover and 3 spacers	silver	5	10
2203 G	26093 3	with privacy cover and 3 spacers	white	5	10
Escutcheon plate 1200 S +	00727 9				6
Escutcheon plate 1200 G +	06369 5				6
Cover 1200/2200	00619 7				12

# 1200

## DOOR VIEWER

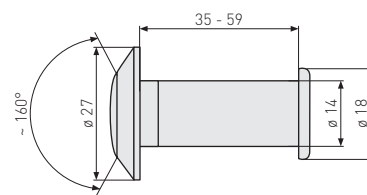

### TECHNOLOGY AND FEATURES

- Wide angle lens: approx. 160°
- Adjustable, for door thicknesses between 35 - 59 mm
- Brass casing
- Easy to fit
- Plastic lens

### CARACTÉRISTIQUES TECHNIQUES

- Champ visuel : 160° environ
- Epaisseur de porte 35 - 59 mm
- Boîtier en laiton
- Montage simple
- Lentille en plastique

### CARACTERÍSTICAS TÉCNICAS

- Angulo de campo visual: 160° aproximadamente
- Para puertas con grosor entre 35 - 59 mm
- Cuerpo de latón
- Montaje simple
- Lente de plástico

Ref. No. Référence Referencia	EAN 4003318	Ø mm	Version Exécution Versión	Finish Coloris Color	Level Degré Nivel	Box Quantity Unité d'emballage Cantidad de cajas
1200 G	31581 7	14		brass-colored	3	10
1200 S	32906 7	14		nickel-plated	3	10

# 1200 | 2200 | 2300

## ESCUTCHEON PLATE (ACCESSORY FOR DOOR VIEWERS)



### TECHNOLOGY AND FEATURES

- Metal rosette
- External diameter: 50 mm

### CARACTÉRISTIQUES TECHNIQUES

- Rosace en métal
- Diamètre extérieur : 50 mm

### CARACTERÍSTICAS TÉCNICAS

- Roseta de metal
- Diámetro externo: 50 mm

Ref. No. Référence Referencia	EAN 4003318	Ø mm	Version Exécution Versión	Finish Coloris Color	Level Degré Nivel	Box Quantity Unité d'emballage Cantidad de cajas
Escutcheon Plate S	01178 8			silver		12
Escutcheon Plate B	01180 1			brown		12
Escutcheon Plate G	01179 5			gold		12

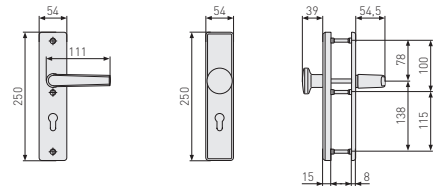

### TECHNOLOGY AND FEATURES

- According to DIN EN 1906 SK 1 and DIN 18 257 ES 0
- Increased leverage resistance: solid cams plus inner screws
- Proven layered construction: hardened steel bottom plate, plus sturdy cover plate
- Thickness: 15 mm
- Spacing: 72 mm, square bolt: 8 mm

### CARACTÉRISTIQUES TECHNIQUES

- Conforme à la DIN EN 1906 classe 1 et DIN 18 257 ES 0
- Protection améliorée contre l'arrachement, came cémentée, plus fixation sur contreplaqué intérieure
- Construction «coffre-fort» éprouvée : plaque de base en acier, plus garniture en aluminium
- Épaisseur de la plaque 15 mm
- Entraxe : 72 mm, tige carrée : 8 mm

### CARACTERÍSTICAS TÉCNICAS

- Según DIN EN 1906 SK 1 y DIN 18257 ES 0
- Protección antiextracción reforzada: Levas estables junto con atornilladuras internas
- Construcción laminada acreditada: Placa inferior de metal junto con placa de cubierta de aleación ligera
- Placa de 15 mm de grosor
- Separación: 72 mm, cuadradillo: 8 mm

Ref. No. Référence Referencia	EAN 4003318	Cylinder Protrusion mm Dépassement du Cylindre mm Protuberancia de Cilindro mm	Version Exécution Versión	Finish Coloris Color	Level Degré Nível	Box Quantity Unité d'emballage Cantidad de cajas
KLS114 F1 EK	21032 7	15	handle set	F1	5	1
KLS114 F2 EK	08300 6	15	handle set	F2	5	1
KLS114 F3 EK	08298 6	15	handle set	F3	5	1
KLS114 F4 EK	08296 2	15	handle set	F4	5	1
KLS114 F9 EK	31704 0	15	handle set	F9	5	1
KLS114 F1 b. Dr. EK	21033 4	15	two handles	F1	5	1
KLS114 F2 b. Dr. EK	08299 3	15	two handles	F2	5	1
KLS114 F3 b. Dr. EK	08297 9	15	two handles	F3	5	1
KLS114 F4 b. Dr. EK	08295 5	15	two handles	F4	5	1
KLS114 F9 b. Dr. EK	31705 7	15	two handles	F9	5	1

# KLZS714

## DOOR FITTING WITH STEEL CYLINDER PROTECTION - SQUARE

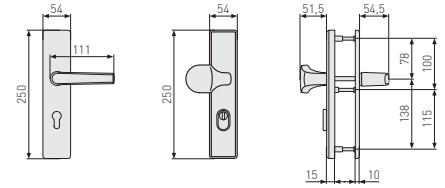

4X108



### TECHNOLOGY AND FEATURES

- Certified according to DIN EN 1906 SK 2 and DIN 18 257 ES 1 ZA, VdS approved
- High resistance due to the layer construction: several bottom plates, with a total of 13.5 mm thickness, for high protection
- High impact resistance: extra long steel cams, complete with tempered special screws (3 x M6)
- An additional steel inset provides extra strong leverage/tear-off resistance
- Integrated pulling protection with cylinder cover plus freely rotating special steel disc
- Grip plate adjustable to DIN left and right doors
- HLZS: spacing: 92 mm, square bolt: 10 mm
- KLZS: spacing: 72 mm, square bolt: 8 mm

### CARACTÉRISTIQUES TECHNIQUES

- Conforme aux DIN EN 1906 classe 2 et DIN 18 257 classe 1 ZA, VdS (Instituts de Contrôle Technique RFA)
- Résistance maximale grâce à la construction «coffre-fort» de plusieurs plaques de base (épaisseur totale de 13,5 mm) en acier pour une protection maximale
- Haute résistance aux coups : came de fixation extra-longue et boulons en acier spécial (3 x M6)
- Protection anti-arrachage extrême par contre-plaque intérieure en acier
- Protection du cylindre : anti-perçage par rosace rotative en acier spécial devant le cylindre
- Bouton adaptable pour porte DIN gauche et DIN droite
- HLZS : entraxe : 92 mm, tige carrée : 10 mm
- KLZS : entraxe : 72 mm, tige carrée : 8 mm

### CARACTERÍSTICAS TÉCNICAS

- Reconocimiento VdS, certificación DIN según DIN EN 1906 SK2 y DIN 18257 ES1
- Gran estabilidad general gracias a la construcción laminada; varias placas de acero para lograr una excelente protección
- Alta resistencia a los impactos: Levas de acero extralargas junto con tornillos templados especiales M6
- Alta resistencia a los intentos de arrancamiento gracias al núcleo de acero de la placa interior
- Protección antiextracción integrada y disco de acero especial de rotación libre
- Posibilidad de cambiar la posición de la placa de agarre para DIN derecha o DIN izquierda
- HLZS: Separación: 92 mm, cuadradillo: 10 mm
- KLZS: Separación: 72 mm, cuadradillo: 8 mm

Ref. No. Référence Referencia	EAN 4003318	Cylinder Protrusion mm Dépassement du Cylindre mm Protuberancia de Cilindro mm	Version Exécution Versión	Finish Coloris Color	Level Degré Nível	Box Quantity Unité d'emballage Cantidad de cajas
KLZS714 F1 EK	20354 1	10-18	handle set	F1	8	1
KLZS714 F2 EK	08428 7	10-18	handle set	F2	8	1
KLZS714 F3 EK	08426 3	10-18	handle set	F3	8	1
KLZS714 F4 EK	08425 6	10-18	handle set	F4	8	1
KLZS714 F2 SB	08427 0	10-18	handle set	F2	8	1
KLZS714 F1 b. Dr. EK	20731 0	10-18	two handles	F1	8	1
KLZS714 F2 b. Dr. EK	08422 5	10-18	two handles	F2	8	1
KLZS714 F3 b. Dr. EK	08421 8	10-18	two handles	F3	8	1
KLZS714 F4 b. Dr. EK	08420 1	10-18	two handles	F4	8	1

# AC7023

## DOOR CLOSER

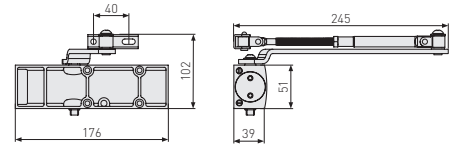
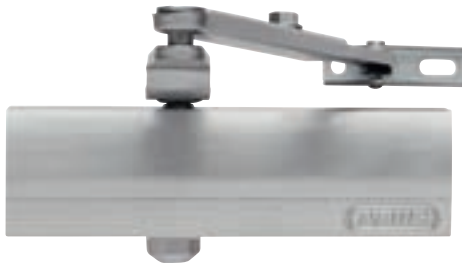

### TECHNOLOGY AND FEATURES

- Suitable for a door weight of 40 up to 80 kg
- Max. door width 850 up to 1100 mm
- Adjustable closing speeds
- EN power size 2 - 4 (< 105°)
- Certified according to EN 1154 class 3 and EN1634
- Fixing arm optionally available

### CARACTÉRISTIQUES TECHNIQUES

- Convient pour une porte de 40 à 80 kg
- Largeur de porte maximale de 850 à 1100 mm
- Vitesses de fermeture réglables
- Classe EN 2 - 4 (< 105°)
- Certifications EN 1154 classe 3 et EN1634
- Bras de fixation disponible en option

### CARACTERÍSTICAS TÉCNICAS

- Apropriado para puertas de entre 40 y 80 kg de peso
- Anchura máxima de la puerta entre 850 y 1100 mm
- Velocidad de cierre ajustable
- Clase EN 2 - 4 (<105°)
- Certificados EN 1154 clase 3 y EN1634
- Brazo de ajuste fijo opcional



Ref. No. Référence Referencia	EAN 4003318	Version Exécution Versión	Finish Coloris Color	Box Quantity Unité d'emballage Cantidad de cajas
AC7023	72838 9	fixed closing force EN 2,3, 4 (up to 105°); max. 80 kg	silver	6

# AC7436

## DOOR CLOSER

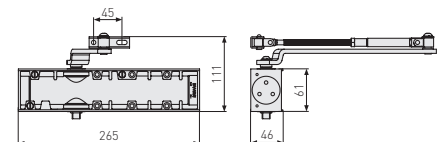

### TECHNOLOGY AND FEATURES

- Suitable for a door weight of 60 up to 120 kg
- Max. door width 950 up to 1400 mm
- Adjustable closing speeds
- Adjustable closing force
- Hydraulic opening buffer
- EN power size 3 - 6

### CARACTÉRISTIQUES TECHNIQUES

- Convient pour une porte de 60 à 120 kg
- Largeur de porte maximale de 950 à 1400 mm
- Vitesses de fermeture réglables
- Force de fermeture réglable
- Freinage à l'ouverture
- Classe EN 3 - 6

### CARACTERÍSTICAS TÉCNICAS

- Apropriado para puertas de entre 60 y 120 kg de peso
- Ancho de puerta máximo entre 950 y 1400 mm
- Velocidad de cierre ajustable
- Fuerza de cierre ajustable
- Amortiguación de apertura
- Clase EN 3 - 6



Ref. No. Référence Referencia	EAN 4003318	Version Exécution Versión	Finish Coloris Color	Box Quantity Unité d'emballage Cantidad de cajas
AC7436	72842 6	variable closing force EN3-6, incl. backcheck, 60-150 kg	silver	4

# AC7303

## DOOR CLOSER

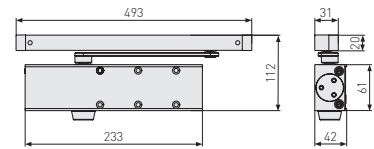

### TECHNOLOGY AND FEATURES

- Universal application for closer size EN 3
- Max. door width up to 950 mm (60 kg)
- Certified according to DIN EN 1154
- Incl. side arm and hydraulic opening buffer

### CARACTÉRISTIQUES TECHNIQUES

- Utilisation universelle pour taille de fermeture EN 3
- Pour largeurs de porte jusqu'à 950 mm (60 kg)
- Certifié selon DIN EN 1154
- Glissière et freinage à l'ouverture inclus

### CARACTERÍSTICAS TÉCNICAS

- Aplicación universal para tamaño de cierre EN 3
- Para puertas de hasta 950 mm de ancho (60 kg)
- Certificación según DIN EN 1154
- Incl. guía de deslizamiento y amortiguación de apertura



Ref. No. Référence Referencia	EAN 4003318	Version Exécution Versión	Finish Coloris Color	Box Quantity Unité d'emballage Cantidad de cajas
AC7303	73098 6	fixed closing force EN3, sliding rail, up to 60 kg	silver	1

# AC7124

## DOOR CLOSER

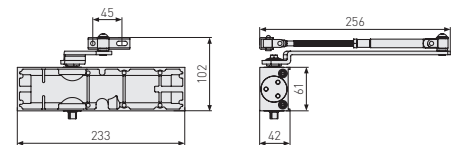
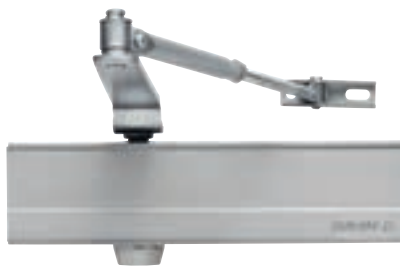

### TECHNOLOGY AND FEATURES

- Suitable for a door weight of 40 up to 80 kg
- Max. door width 850 up to 1100 mm
- Adjustable closing speeds
- Adjustable closing force
- Hydraulic opening buffer
- EN power size 2 - 4
- Fixing arm optionally available

### CARACTÉRISTIQUES TECHNIQUES

- Convient pour une porte de 40 à 80 kg
- Largeur de porte maximale de 850 à 1100 mm
- Vitesses de fermeture réglables
- Force de fermeture réglable
- Avec freinage à l'ouverture
- Classe EN 2 - 4
- Bras de fixation disponible en option

### CARACTERÍSTICAS TÉCNICAS

- Apropriado para puertas de entre 40 y 80 kg de peso
- Anchura máxima de la puerta entre 850 y 1100 mm
- Velocidad de cierre ajustable
- Fuerza de cierre ajustable
- Con amortiguación de apertura
- Clase EN 2 - 4
- Brazo de ajuste fijo opcional



Ref. No. Référence Referencia	EAN 4003318	Version Exécution Versión	Finish Coloris Color	Box Quantity Unité d'emballage Cantidad de cajas
AC7124	72839 6	variable closing force EN2-4, incl. backcheck, silver, max. 80 kg	silver	6



# AC4223

## DOOR CLOSER

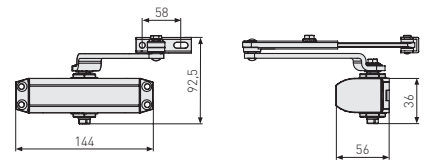
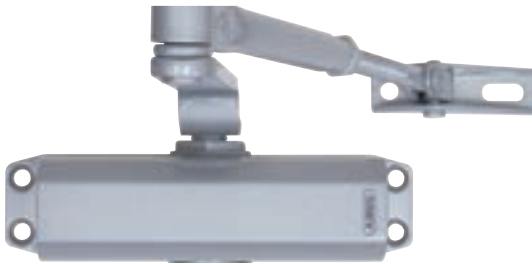

### TECHNOLOGY AND FEATURES

- Suitable for a door weight of 40 up to 60 kg
- Max. door width 850 up to 950 mm
- Adjustable closing speeds
- EN power size 2 - 3

### CARACTÉRISTIQUES TECHNIQUES

- Convient pour une porte de 40 à 60 kg
- Largeur de porte maximale de 850 à 950 mm
- Vitesses de fermeture réglables
- Classe EN 2 - 3

### CARACTERÍSTICAS TÉCNICAS

- Apropriado para puertas de entre 40 y 60 kg de peso
- Anchura máxima de la puerta de entre 850 y 950 mm
- Velocidad de cierre ajustable
- Clase EN 2 - 3



Ref. No. Référence Referencia	EAN 4003318	Version Exécution Versión	Finish Coloris Color	Box Quantity Unité d'emballage Cantidad de cajas
AC4223	72831 0	fixed closing size EN 2,3 ; max. 60 kg	silver	6

# AC4100

## DOOR CLOSER

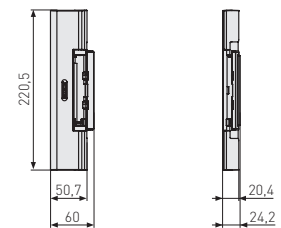

### TECHNOLOGY AND FEATURES

- Suitable for a door weight of up to maximum 40 kg
- Can be used DIN left and DIN right
- Easy assembly without drilling

### CARACTÉRISTIQUES TECHNIQUES

- Convient pour une porte de 40 kg maximum
- Utilisable pour les portes DIN gauche et DIN droite
- Montage facile sans perçage

### CARACTERÍSTICAS TÉCNICAS

- Apropriado para puertas de hasta 40 kg de peso
- Posibilidad de uso en DIN izquierda y DIN derecha
- Montaje fácil sin taladrar



Ref. No. Référence Referencia	EAN 4003318	Version Exécution Versión	Finish Coloris Color	Box Quantity Unité d'emballage Cantidad de cajas
AC4100	73345 1	adjustable closing force, max. 40 kg	silver	1
AC4100	73344 4	adjustable closing force, max. 40 kg	silver	1

# TS40AL

## DOOR CLOSER

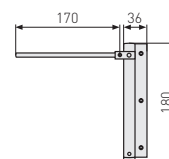

### TECHNOLOGY AND FEATURES

- Suitable for a door weight of up to maximum 40 kg
- Can be used DIN left and DIN right

### CARACTÉRISTIQUES TECHNIQUES

- Convient pour une porte de 40 kg maximum
- Utilisable pour les portes DIN gauche et DIN droite

### CARACTERÍSTICAS TÉCNICAS

- Apropriado para puertas de hasta 40 kg de peso
- Posibilidad de uso en DIN izquierda y DIN derecha



Ref. No. Référence Referencia	EAN 4003318	Version Exécution Versión	Finish Coloris Color	Box Quantity Unité d'emballage Cantidad de cajas
TS40AL	78808 6		aluminium	3

# 2603

## DOOR CLOSER

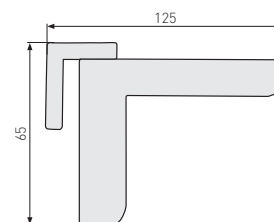

### TECHNOLOGY AND FEATURES

- Closing speed adjustable in 3 steps
- Can be taken off anytime
- No drilling, no screwing
- For rebates up to 16 mm

### CARACTÉRISTIQUES TECHNIQUES

- 3 niveaux de réglage pour la force de fermeture
- Démontable à tout moment
- Sans perçage, sans vis
- Pour rainure de porte jusqu'à 16 mm

### CARACTERÍSTICAS TÉCNICAS

- Velocidad de cierre ajustable en tres pasos
- Removible en cualquier momento
- Fijación sin taladrar y atornillar
- Para solapas de hasta 16 mm

Ref. No. Référence Referencia	EAN 4003318	Version Exécution Versión	Finish Coloris Color	Box Quantity Unité d'emballage Cantidad de cajas
2603	44182 0	closing force adjustable in 3 stages	silver	5
2603	46891 9	closing force adjustable in 3 stages	white	5



## MORTISE LOCK FOR FLAT ENTRANCE DOORS

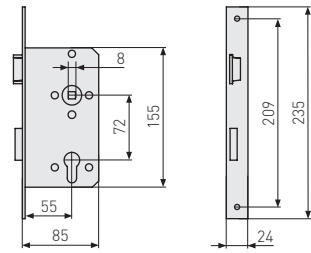

### TECHNOLOGY AND FEATURES

- According to DIN 18251-1, Class 2
- Latch and bolt made of metal
- Lock case closed on all sides, zinc plated
- Suitable for DIN left and DIN right thanks to rotatable latch

### CARACTÉRISTIQUES TECHNIQUES

- Selon la norme DIN 18251-1, classe 2
- Serrure et pêne dormant en métal
- Coffre fermé sur tous les côtés, zingué
- Convient pour DIN gauche et DIN droite grâce au loquet rotatif

### CARACTERÍSTICAS TÉCNICAS

- Según DIN 18251-1, clase 2
- Resbalón y paletón de metal
- Caja cerrada por todos los lados, galvanizada
- Apta para DIN izquierda y DIN derecha gracias al resbalón reversible

Ref. No. Référence Referencia	EAN 4003318	Distance measure mm Mesure distance mm Distancia mm	Forend mm Tête mm Manguito mm	Backset mm Entraxe mm Medida del macho mm	Nut mm Écrou mm Tuerca mm	Finish Color Color	Level Degré Nivel	Box Quantity Unité d'emballage Cantidad de cajas
ES PZ2 R S 55 72 20	61706 5	72	20	55	8	silver	7	1
ES PZ2 L S 55 72 20	61705 8	72	20	55	8	silver	7	1

# TKZ40

## AUTOM. LOCKING MORTISE LOCK FOR FLAT ENTRANCE DOORS

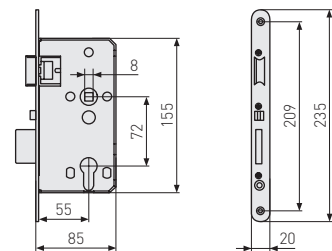
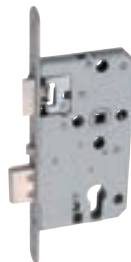

### TECHNOLOGY AND FEATURES

- For standard door cylinders (no free-turning cam needed)
- Latch brass nickel-plated, square bolt malleable iron
- High capacity of resistance by use of high quality materials
- With anti-panic feature (can be opened with the handle from the inside)
- According to DIN 18251 class 3
- Steel bolt with 21 mm protrusion
- Stainless-steel forend

### CARACTÉRISTIQUES TECHNIQUES

- Pour cylindre de porte standard ( aucune fonction débrayable nécessaire )
- Pêne en laiton nickelé en acier en fonte malléable
- Longue durée de vie par l'utilisation de matériaux de qualité
- Avec fonction anti-panique ( ouverture de l'intérieur avec le bouton )
- Conforme à la DIN 18251 Classe 3
- Verrou métallique de 21 mm
- Embout en acier inoxydable

### CARACTERÍSTICAS TÉCNICAS

- Para cilindros para puerta estándar (no se requiere función de apertura libre)
- Resbalón de latón níquelado, nueva de fundición maleable
- Alta resistencia al desgaste gracias al uso de materiales de gran calidad
- Con función antipánico (se abre desde el interior con la manilla)
- Según DIN 18251 clase 3
- Paletón de acero con salida de 21 mm
- Manguito de acero inoxidable

Ref. No. Référence Referencia	EAN 4003318	Distance measure mm Mesure distance mm Distancia mm	Forend mm Tête mm Manguito mm	Backset mm Entraxe mm Medida del macho mm	Nut mm Écrou mm Tuerca mm	Finish Color Color	Level Degré Nivel	Box Quantity Unité d'emballage Cantidad de cajas
TKZ40/20 R/L ER PZ	45551 3	72	20	55	8	Stainless steel	9	3

## MORTICE LOCK FOR FLAT ENTRANCE DOORS

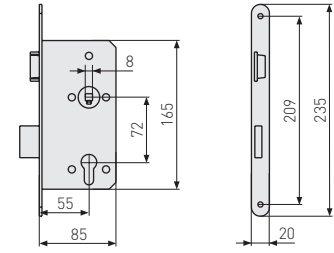

### TECHNOLOGY AND FEATURES

- According to DIN 18251-1, Class 3
- Can be used DIN L and DIN R
- Nut (8 mm) made of metal
- Latch and bolt made of metal
- Distance measurement 72 mm
- Backset 55 mm
- Forend 20 x 235 mm (round), stainless steel
- Lock case 160 x 85 mm
- Only the latch is actuated when the door is pulled shut, latch throw 10 mm
- The bolt will be locked when the door is closed, bolt throw 11/21,7 mm (two turns)

### CARACTÉRISTIQUES TECHNIQUES

- Selon la norme DIN 18251-1, classe 2
- DIN L et DIN R utilisables
- Fouillot (8 mm) métal
- Loquet et pêne dormant en métal
- Mesure distance 72 mm
- Entraxe 55 mm
- Têtière 20 x 235 mm (ronde), acier inoxydable
- Coffre 160 x 85 mm
- Lors de la fermeture de la porte, seul le loquet est actionné, course du loquet 10 mm
- Le verrouillage n'inclut pas le pêne, la course du pêne est de 11/21,7 mm (deux tours)

### CARACTERÍSTICAS TÉCNICAS

- Según DIN 18251-1, clase 2
- Posibilidad de uso en DIN izquierda y DIN derecha
- Nueca (8 mm) de metal
- Resbalón y paletón de metal
- Distancia entre ejes 72 mm
- Medida de entrada 55 mm
- Frente 20 x 235 mm (redondeado), acero inoxidable
- Caja de la cerradura 160 x 85 mm
- Al tirar de la puerta, se acciona únicamente el resbalón; medida sobresaliente del resbalón 10 mm
- Al cerrar, se inserta el paletón; medida sobresaliente del paletón 11/21,7 mm (dos turnos)

Ref. No. Référence Referencia	EAN 4003318	Distance measure mm Mesure distance mm Distancia mm	Forend mm Têtière mm Manguito mm	Backset mm Entraxe mm Medida del macho mm	Nut mm Écrou mm Tuerca mm	Finish Coloris Color	Level Degré Nivel	Box Quantity Unité d'emballage Cantidad de cajas
ES PZ3 R ER 55 72 20	66591 2	72	20	55	8	Stainless steel	8	1
ES PZ3 L ER 55 72 20	66590 5	72	20	55	8	Stainless steel	8	1

# ES WC ROUND FOREND

## MORTISE LOCK FOR WC DOORS

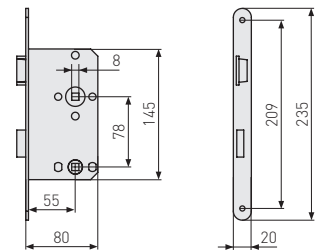

### TECHNOLOGY AND FEATURES

- According to DIN 18251-1, Class 1
- Latch and bolt made of plastic
- Lock case closed on all sides, zinc plated

### CARACTÉRISTIQUES TECHNIQUES

- Selon la norme DIN 18251-1, classe 1
- Loquet et pêne dormant en plastique
- Coffre fermé sur tous les côtés, zingué

### CARACTERÍSTICAS TÉCNICAS

- Según DIN 18251-1, clase 1
- Resbalón y paletón de plástico
- Caja cerrada por todos los lados, galvanizada

Ref. No. Référence Referencia	EAN 4003318	Distance measure mm Mesure distance mm Distancia mm	Forend mm Têtière mm Manguito mm	Backset mm Entraxe mm Medida del macho mm	Nut mm Écrou mm Tuerca mm	Finish Coloris Color	Level Degré Nivel	Box Quantity Unité d'emballage Cantidad de cajas
ES Bad universal S	58395 7	78	20	55	8	silver	3	10

## MORTISE LOCK FOR FLAT ENTRANCE DOORS

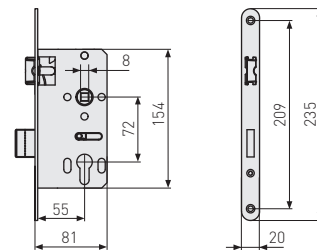

### TECHNOLOGY AND FEATURES

- Universal mortise lock for flat entrance doors
- Nut (8mm) made of metal
- Latch and bolt made of metal, zinc-coated
- Distance measure 72mm
- Backset 55mm
- Forend 20 x 235mm (round)
- Lock case 154 x 81mm
- Lock case closed on top and bottom, zinc-coated
- When the door is pulled shut, only the latch will be engaged
- Latch throw 10mm
- The bolt will be locked when the door is closed
- Bolt throw 11/21mm (two turns)
- Suitable for DIN left and DIN right thanks to rotatable latch

### CARACTÉRISTIQUES TECHNIQUES

- Utilisation DIN D et DIN G universelle grâce au réglage facile du bec-de-cane
- Convient pour les cylindres de porte selon DIN EN1303
- Résistance à l'usure élevée grâce à l'utilisation de matériaux de qualité
- PZ : pêne et bec-de-cane en métal
- BB et salle de bains : pêne et bec-de-cane en plastique de qualité

### CARACTERÍSTICAS TÉCNICAS

- Uso universal en puertas con apertura DIN I o D mediante el desplazamiento del resbalón
- Apta para cilindro para puertas según DIN EN1303
- Alta resistencia al desgaste gracias al uso de materiales de gran calidad
- PZ: Paletón y resbalón de metal
- BB y Bad: Paletón y resbalón de plástico de alta calidad

Ref. No. Référence Referencia	EAN 4003318	Distance measure mm Mesure distance mm Distancia mm	Forend mm Tête mm Manguito mm	Backset mm Entraxe mm Medida del macho mm	Nut mm Écrou mm Tuerca mm	Finish Color Color	Level Degré Nivel	Box Quantity Unité d'emballage Cantidad de cajas
ESK PZ2 universal S	58393 3	72	20	55	8	silver	5	10

# EFS65

## MORTISE LOCK FOR FIRE DOORS

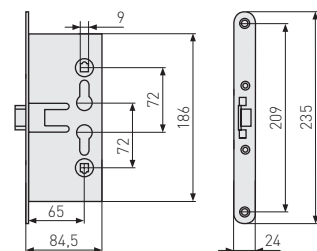

### TECHNOLOGY AND FEATURES

- Steel double bolt with middle latch
- Lock body made from galvanized steel
- Extra solid mechanics
- Tested and supervised by the MPA (official German test institute)
- For DIN left and right doors
- Whisper Latch

### CARACTÉRISTIQUES TECHNIQUES

- Double pêne en acier avec pêne lançant au milieu
- Boîtier en acier galvanisé
- Mécanisme très robuste
- Testée par l'Institut officiel de tests de Allemagne (MPA)
- Application sur portes droites et gauches

### CARACTERÍSTICAS TÉCNICAS

- Paletón doble de acero con resbalón central
- Caja de chapa de acero galvanizado
- Mecanismo extremadamente estable
- Certificación y supervisión MPA
- Para puertas DIN I y D

Ref. No. Référence Referencia	EAN 4003318	Distance measure mm Mesure distance mm Distancia mm	Forend mm Tête mm Manguito mm	Backset mm Entraxe mm Medida del macho mm	Nut mm Écrou mm Tuerca mm	Finish Color Color	Level Degré Nivel	Box Quantity Unité d'emballage Cantidad de cajas
EFS65	21511 7	72	24	65	9	zinc-coated	6	3

MORTISE LOCK FOR FIRE DOORS

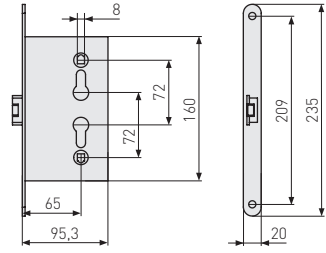

TECHNOLOGY AND FEATURES

- Can be used DIN L and DIN R
- Nut (8mm) made of metal
- Latch and bolt made of zinc die cast
- Distance measurement 72mm
- Backset 65mm
- Forend 20 x 235mm (round), zinc plated
- Lock case 160 x 95.3mm
- Lock case closed on all sides, zinc plated
- Only the latch is actuated when the door is pulled shut, latch throw 11.6mm
- The bolt will be locked when the door is closed, bolt throw 10mm

CARACTÉRISTIQUES TECHNIQUES

- DIN L et DIN R utilisables
- Fouillot (8 mm) métal
- Loquet et pêne dormant en zinc moulé sous pression
- Mesure distance 72 mm
- Entraxe 65 mm
- Tête 20 x 235 mm (ronde), zinguée
- Coffre 160 x 95,3 mm
- Coffre fermé sur tous les côtés, zingué
- Lors de la fermeture de la porte, seul le loquet est actionné, course du loquet 11,6 mm
- Le verrouillage n'inclut pas le pêne, la course du pêne est de 10 mm

CARACTERÍSTICAS TÉCNICAS

- Posibilidad de uso en DIN izquierda y DIN derecha
- Nueca (8 mm) de metal
- Resbalón y paletón de zinc fundido a presión
- Distancia entre ejes 72 mm
- Medida de entrada 65 mm
- Frente 20 x 235mm (redondeado), galvanizado
- Caja de la cerradura 160 x 95,3 mm
- Caja cerrada por todos los lados, galvanizada
- Al tirar de la puerta, se acciona únicamente el resbalón; medida sobresaliente del resbalón 11,6 mm
- Al cerrar, se inserta el paletón; medida sobresaliente del paletón 10 mm

Ref. No. Référence Referencia	EAN 4003318	Distance measure mm Mesure distance mm Distancia mm	Forend mm Tête mm Manguito mm	Backset mm Entraxe mm Medida del macho mm	Nut mm Écrou mm Tuerca mm	Finish Coloris Color	Level Degré Nivel	Box Quantity Unité d'emballage Cantidad de cajas
ES SI PZ LR Z 65 72 20	66592 9	72	20	65	8	zinc-coated	6	1

MORTISE LOCK FOR TUBULAR FRAME DOORS

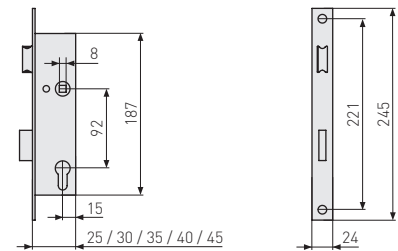

TECHNOLOGY AND FEATURES

- Corresponds to DIN18251-2 (tubular frame doors)
- Latch and bolt made of metal, nickel plated
- Lock case closed on top and bottom, zinc plated
- Suitable for DIN left and DIN right thanks to rotatable latch

CARACTÉRISTIQUES TECHNIQUES

- Conforme à la norme DIN18251-2 (portes à cadre tubulaire)
- Loquet et pêne en métal, nickelé
- Coffre fermé en haut et en bas, zingué
- Convient pour DIN gauche et DIN droite grâce au loquet rotatif

CARACTERÍSTICAS TÉCNICAS

- Cumple con la norma DIN18251-2 (puertas de marco hueco)
- Resbalón y paletón de metal, niquelados
- Caja cerrada en la parte superior e inferior, galvanizada
- Apta para DIN izquierda y DIN derecha gracias al resbalón reversible

Ref. No. Référence Referencia	EAN 4003318	Distance measure mm Mesure distance mm Distancia mm	Forend mm Tête mm Manguito mm	Backset mm Entraxe mm Medida del macho mm	Nut mm Écrou mm Tuerca mm	Finish Coloris Color	Level Degré Nivel	Box Quantity Unité d'emballage Cantidad de cajas
ESR PZ LR Z 25 92 24	61745 4	92	24	25	8	zinc-coated	7	1
ESR PZ LR Z 30 92 24	61746 1	92	24	25	8	zinc-coated	7	1
ESR PZ LR Z 35 92 24	61751 5	92	24	25	8	zinc-coated	7	1
ESR PZ LR Z 40 92 24	61752 2	92	24	25	8	zinc-coated	7	1
ESR PZ LR Z 45 92 24	61753 9	92	24	25	8	zinc-coated	7	1

## ANGLED STRIKE PLATE FOR FRONT DOORS

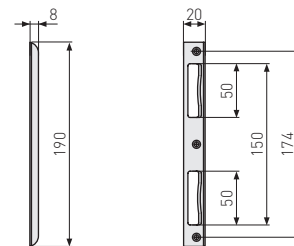

### TECHNOLOGY AND FEATURES

- Steel strike plate
- lacquered surface
- 190mm long
- 20 x 8mm wide

### CARACTÉRISTIQUES TECHNIQUES

- Gâche en acier
- Surface laquée
- 190 mm de long
- 20 x 8 mm de large

### CARACTERÍSTICAS TÉCNICAS

- Cerradero de acero
- Superficie pintada
- 190 mm de largo
- 20 x 8 mm de ancho

Made in Germany

Ref. No. Référence Referencia	EAN 4003318	Length mm Longueur mm Larga mm	Distance Measurement mm Mesure Distance mm Distancia mm	Finish Coloris Color	Level Degré Nivel	Box Quantity Unité d'emballage Cantidad de cajas
WSBHT 190 LR G	62188 8	190	20 x 8	gold		10
WSBHT 190 LR G	62183 3	190	20 x 8	gold		1

## ANGLED STRIKE PLATE FOR FLAT ENTRANCE AND INTERNAL DOORS

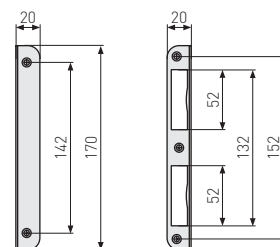

### TECHNOLOGY AND FEATURES

- Steel strike plate
- lacquered surface
- 170mm long
- 20 x 20mm wide

### CARACTÉRISTIQUES TECHNIQUES

- Gâche en acier
- Surface laquée
- 170 mm de long
- 20 x 20 mm de large

### CARACTERÍSTICAS TÉCNICAS

- Cerradero de acero
- Superficie pintada
- 170 mm de largo
- 20 x 20 mm de ancho

Made in Germany

Ref. No. Référence Referencia	EAN 4003318	Length mm Longueur mm Larga mm	Distance Measurement mm Mesure Distance mm Distancia mm	Finish Coloris Color	Level Degré Nivel	Box Quantity Unité d'emballage Cantidad de cajas
WSB 170 LR G	62177 2	170	20 x 20	gold		10
WSB 170 LR S	88987 5	170	20 x 20	silver		10
WSB 170 LR G	62178 9	170	20 x 20	gold		1
WSB 170 LR S	62180 2	170	20 x 20	silver		1



## ANGLED STRIKE PLATE FOR FLAT ENTRANCE AND INTERNAL DOORS

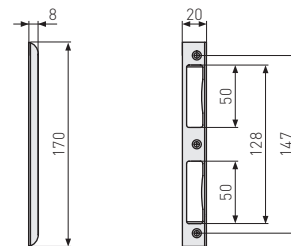

### TECHNOLOGY AND FEATURES

- Steel strike plate
- lacquered surface
- with additional plastic cover to visually cover the opening of the bolt and latch
- 170mm long

### CARACTÉRISTIQUES TECHNIQUES

- Gâche en acier
- Surface laquée
- Avec un couvercle en plastique supplémentaire pour masquer visuellement la percée du pêne et du loquet
- 170 mm de long
- 20 x 8 mm de large

### CARACTERÍSTICAS TÉCNICAS

- Cerradero de acero
- Superficie pintada
- Con una cubierta de plástico adicional para cubrir visualmente el avance del paletón y el pestillo
- 170 mm de largo
- 20 x 8 mm de ancho

Made in Germany

Ref. No. Référence Referencia	EAN 4003318	Length mm Longueur mm Larga mm	Distance Measurement mm Mesure Distance mm Distancia mm	Finish Coloris Color	Level Degré Nivel	Box Quantity Unité d'emballage Cantidad de cajas
WSB 170 LR G KU	62190 1	170	20 x 8	gold		1
WSB 170 LR S KU	62191 8	170	20 x 8	silver		1
WSB 170 LR G KU	62189 5	170	20 x 8	gold		10
WSB 170 LR S KU	88988 2	170	20 x 8	silver		10

# FSB 250 EÖ

## FLAT STRIKE PLATE FOR FRONT DOORS WITH DOOR OPENERS

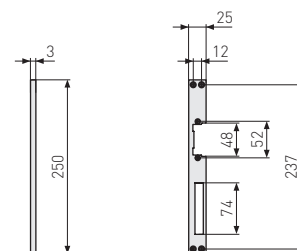

### TECHNOLOGY AND FEATURES

- For Front doors
- Can be used with choice of combination with door openers ET 50/60/70/75/80/85 and MT 90
- Universally usable with DIN right and left-opening doors
- Steel strike plate

### CARACTÉRISTIQUES TECHNIQUES

- Pour portes de maison
- Peut être utilisé avec un choix de combinaison avec des ouvre-portes ET 50/60/70/75/80/85 et MT 90
- Possibilité d'utilisation sur DIN gauche et DIN droite
- Gâche en acier

### CARACTERÍSTICAS TÉCNICAS

- Para puertas de casa
- Se puede utilizar con la opción de combinación con abrepuertas ET 50/60/70/75/80/85 y MT 90
- Posibilidad de uso en DIN izquierda y DIN derecha
- Cerradero de acero

Made in Germany

Ref. No. Référence Referencia	EAN 4003318	Length mm Longueur mm Larga mm	Distance Measurement mm Mesure Distance mm Distancia mm	Finish Coloris Color	Level Degré Nivel	Box Quantity Unité d'emballage Cantidad de cajas
FSB 250 LR Z EÖ	62192 5	250	25	zinc-coated		5

# SSB400

## ANGLED STRIKE PLATE FOR FRONT DOORS

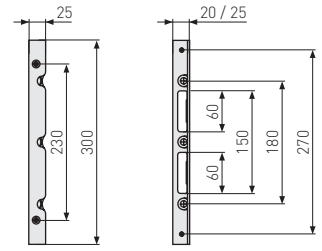

### TECHNOLOGY AND FEATURES

- Fixed three-point anchoring in masonry
- With latch adjustment

### CARACTÉRISTIQUES TECHNIQUES

- Solide fixation à 3 points dans le mur
- Rouleau ajustable et décondamnation manuelle

### CARACTERÍSTICAS TÉCNICAS

- Anclaje fijo de tres puntos en la pared
- Incl. tacos y material de montaje



Ref. No. Référence Referencia	EAN 4003318	Length mm Longueur mm Larga mm	Distance Measurement mm Mesure Distance mm Distancia mm	Finish Coloris Color	Level Degré Nivel	Box Quantity Unité d'emballage Cantidad de cajas
SSB400 S 20x25	05538 6	300	20 x 25	silver	9	3
SSB400 S 20x25	05541 6	300	20 x 25	silver	9	3



# FTR90 / PB92

## PUSH BOLT

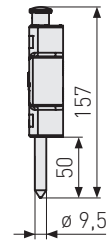
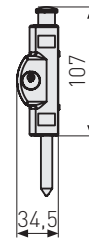

### TECHNOLOGY AND FEATURES

- 50 mm bolt made of stainless steel
- Robust zinc diecast housing
- PVC cover that locks in place
- Simple installation, concealed fixing
- Incl. two keys
- Mounting set is supplied

### CARACTÉRISTIQUES TECHNIQUES

- Boulons de 50 mm en acier inoxydable
- Boîtier robuste en fonte de zinc
- Couvercle en PVC à enclenchement
- Montage facile, vis dissimulées
- Deux vis incluses
- Le matériel de fixation est compris dans la livraison

### CARACTERÍSTICAS TÉCNICAS

- Pernos de acero inoxidable de 50 mm
- Carcasa robusta de zinc de fundición a presión
- Cubiertas de plástico encajadas
- Montaje fácil, tornillos ocultos
- Dos llaves incluidas
- Material de fijación incluido



Ref. No. Référence Referencia	EAN 4003318	Version Exécution Versión	Finish Coloris Color	Level Degré Nivel	Box Quantity Unité d'emballage Cantidad de cajas
FTR90 B AL0125 B/DEFSP	78234 3		brown	4	4
FTR90 W AL01 25 B/DEFSP	77072 2		white	4	4

# FTR70

## PUSH BOLT

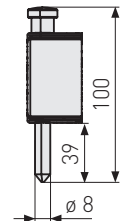
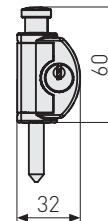

### TECHNOLOGY AND FEATURES

- 40-mm-long stainless steel bolt
- Robust zinc diecast housing
- PVC cover that locks in place
- Simple installation, concealed fixing
- Includes two keys
- Mounting set is supplied
- Locking without a key, opening with a key

### CARACTÉRISTIQUES TECHNIQUES

- Boulons de 40 mm en acier inoxydable
- Boîtier robuste en fonte de zinc
- Couvercle en PVC à enclenchement
- Montage facile, vis dissimulées
- Deux vis incluses
- Le matériel de fixation est compris dans la livraison
- Verrouillage sans clé, ouverture avec clé

### CARACTERÍSTICAS TÉCNICAS

- Pernos de acero inoxidable de 40 mm
- Carcasa robusta de zinc de fundición a presión
- Cubiertas de plástico encajadas
- Montaje fácil, tornillos ocultos
- Dos llaves incluidas
- Material de fijación incluido
- Bloquear sin llave, abrir con llave



Ref. No. Référence Referencia	EAN 4003318	Version Exécution Versión	Finish Coloris Color	Level Degré Nivel	Box Quantity Unité d'emballage Cantidad de cajas
FTR70 W AL01 25 B/DEFSP	73401 4		white	4	4

# FTR42 / PB42

## PUSH BOLT

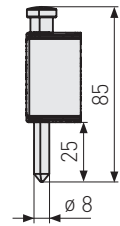
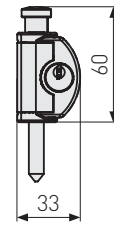

### TECHNOLOGY AND FEATURES

- 24-mm-long stainless steel bolt
- Robust zinc diecast housing
- Includes two keys
- Mounting set is supplied

### CARACTÉRISTIQUES TECHNIQUES

- Boulons de 24 mm en acier inoxydable
- Boîtier robuste en fonte de zinc
- Deux clés incluses
- Le matériel de fixation est compris dans la livraison

### CARACTERÍSTICAS TÉCNICAS

- Pernos de acero inoxidable de 24 mm
- Carcasa robusta de zinc de fundición a presión
- Dos llaves incluidas
- Material de fijación incluido



Ref. No. Référence Referencia	EAN 4003318	Version Exécution Versión	Finish Coloris Color	Level Degré Nivel	Box Quantity Unité d'emballage Cantidad de cajas
FTR42 W AL01 25 B/DEFSPP	56906 7		white	4	6

# FTR38 / PB38

## PUSH BOLT

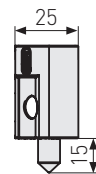
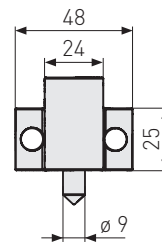

### TECHNOLOGY AND FEATURES

- Window bars with 15-mm-long stainless steel bolts
- Convenient handling due to deadlocking mechanism
- Mounted with two screws on the window sash
- Includes two keys

### CARACTÉRISTIQUES TECHNIQUES

- Barre de protection pour fenêtre avec boulon en acier inoxydable de 15 mm
- Confort d'utilisation grâce au cylindre à pression
- Fixation avec 2 vis au niveau du battant de fenêtre
- Deux vis incluses

### CARACTERÍSTICAS TÉCNICAS

- Barra de bloqueo para ventana con pernos de acero inoxidable de 15 mm
- Manejo sencillo gracias a los cilindros de presión
- Fijación a la hoja con 2 tornillos
- Dos llaves incluidas

Ref. No. Référence Referencia	EAN 4003318	Version Exécution Versión	Finish Coloris Color	Level Degré Nivel	Box Quantity Unité d'emballage Cantidad de cajas
FTR38 B AL0125 B/DEFSPP	78235 0		brown		4
FTR38 W AL01 25 B/DEFSPP	77071 5		white		4

# FTS88

## STABLE WINDOW LOCK

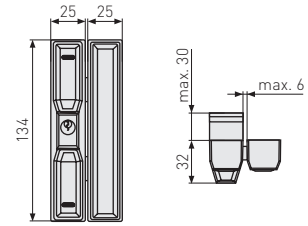

### TECHNOLOGY AND FEATURES

- VdS and DIN-certified
- Resists more than one ton load
- Solid steel bolt with the ABUS typical claw bolts
- Sturdy lock case
- Universal range of use
- Incl. two keys
- Ideally suited for tight installation spaces

### CARACTÉRISTIQUES TECHNIQUES

- Reconnu VdS et DIN
- Résistance mécanique de plus d'une tonne
- Pêne acier à crochet
- Boîtier robuste et gâche en acier
- Application universelle
- Deux clés incluses
- Solution idéale pour les espaces de montage étroits

### CARACTERÍSTICAS TÉCNICAS

- Reconocido por VdS y DIN
- Resiste más de 1 tonelada de fuerza exterior
- Alta resistencia a la palanca por la forma de garra de las condenas
- Cuerpo macizo y doble condena de acero
- Aplicación universal
- Incluye dos llaves
- Da excelentes posibilidades para su colocación en estrechos perfiles o para anclarlo a la pared



6N008 N 2007 207



Ref. No. Référence Referencia	EAN 4003318	Version Exécution Versión	Finish Coloris Color	Level Degré Nivel	Box Quantity Unité d'emballage Cantidad de cajas
FTS88 B EK	10754 2		brown	9	1
FTS88 W EK	10753 5		white	9	1
FTS88 W B/EFSP	52841 5		white	9	2
Drill Template FTS88	10285 1				1

# FAS97

## AUTOMATIC PROTECTION FOR THE HINGE SIDE OF THE WINDOW

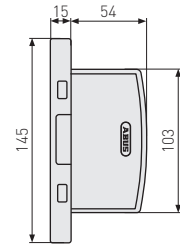

### TECHNOLOGY AND FEATURES

- VdS approved, DIN tested
- Resists more than one ton load
- Convenient handling for tilt/turn handles: unlock by tilting without keys, locks automatically when closing the window
- Covered screws
- Ideal in combination with additional window handle locks

### CARACTÉRISTIQUES TECHNIQUES

- Homologuée VdS, conformité DIN
- Résistance mécanique de plus d'une tonne
- Utilisation aisée avec des garnitures rotatives/votantes : désenclenchement sans clé, enclenchement automatique à la fenêtre
- Vis masquées
- Combinaison idéale avec verrous supplémentaires de poignée de fenêtre

### CARACTERÍSTICAS TÉCNICAS

- Reconocido por VdS, certificado DIN
- Resistente a presiones de más de 1 tonelada
- Apertura sin la llave. Cierre automático cerrando la ventana
- Montaje fácil: Tornillos escondidos
- Apropiado para combinar con manillas para oscilobatientes



6N004 N 2007 207



Ref. No. Référence Referencia	EAN 4003318	Version Exécution Versión	Finish Coloris Color	Level Degré Nivel	Box Quantity Unité d'emballage Cantidad de cajas
FAS97 B EK	11780 0		brown	10	1
FAS97 W EK	11782 4		white	10	1
FAS97 S EK	72240 0		silver	10	1
FAS97 B B/SB	11781 7		brown	10	2
Drill Template FAS97	10376 6				1

# RS97

## ROLLER SHUTTER LOCK

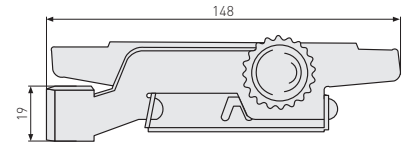

### TECHNOLOGY AND FEATURES

- Two clamps connect between the slats and guiding rail, and are secured with a screw

### CARACTÉRISTIQUES TECHNIQUES

- Montage par paire à gauche et à droite du cadre de la fenêtre

### CARACTERÍSTICAS TÉCNICAS

- Se fija a la persiana, entre las lamas y las guías del marco de la ventana, simplemente girando y apretando el tornillo

Made in Germany

Ref. No. Référence Referencia	EAN 4003318	Version Exécution Versión	Finish Coloris Color	Level Degré Nivel	Box Quantity Unité d'emballage Cantidad de cajas
RS97 CLC/DFNLI	33689 8	Assembly in pairs		2	3

# RS87

## ROLLER SHUTTER LOCK

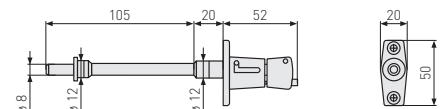

### TECHNOLOGY AND FEATURES

- Spring loaded opening mechanism
- The solid steel pin protects the roller shutter from being lifted up
- Undetectable from the outside
- To be fitted in pairs on the left and right side of the frame

### CARACTÉRISTIQUES TECHNIQUES

- Mécanisme de déverrouillage à ressorts
- La tige en acier robuste protège le volet roulant contre le relevage
- Le dispositif de sécurité est invisible de l'extérieur
- Montage par paire à gauche et à droite du cadre de la fenêtre

### CARACTERÍSTICAS TÉCNICAS

- Cómoda apertura con muelle
- El robusto pasador de acero protege la persiana para que no se suba
- Indetectable desde el exterior

Made in Germany

Ref. No. Référence Referencia	EAN 4003318	Version Exécution Versión	Finish Coloris Color	Level Degré Nivel	Box Quantity Unité d'emballage Cantidad de cajas
RS87 B B/EFSP	52842 2	Assembly in pairs	brown	3	3
RS87 W B/EFSP	52843 9	Assembly in pairs	white	3	3
RS87 B CL/DFNLI	35243 0	Assembly in pairs	brown	3	3
RS87 W CL/DFNLI	35244 7	Assembly in pairs	white	3	3

# FG300A

## LOCKABLE WINDOW HANDLE WITH ALARM

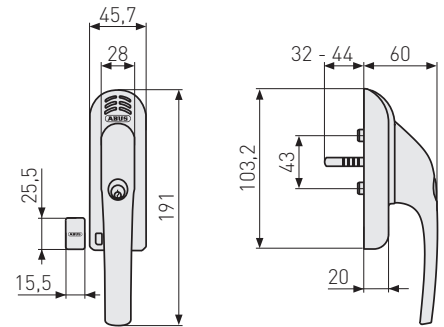

GBM 7300



9N004



### TECHNOLOGY AND FEATURES

- Activated pressure cylinder prevents opening of the window handle and arms the alarm function
- Individually adjustable, secured square bolt
- Keyed-alike combination possible with other ABUS security devices
- Integrated 110dBA (+/- 2 dBA) alarm siren as used in the Detecto 7000
- Standard alkaline batteries (2 x AAA), replaceable, battery life of up to two years
- Glass break detector available as an option (GBM7300)
- According to DIN18267 class 2
- 200Nm resistance against twisting and tearing off

### CARACTÉRISTIQUES TECHNIQUES

- Cylindre bouton poussoir pour prévenir les ouvertures de la fenêtre et permet l'activation de l'alarme
- Carré réglable, avec protection anti-arrachage, 32-44 mm de long
- Fermeture universelle commune combinable avec d'autres verrous pour fenêtre ABUS
- Sirène d'alarme de 110 dBA intégrée
- Piles alcalines usuelles (2 x AAA), remplaçables, durée de fonctionnement jusqu'à 2 ans
- Détecteurs de bris de vitre disponible en option (GBM7300)
- DIN18267 classe 2
- Résistance de 200Nm contre arracher et éteindre

### CARACTERÍSTICAS TÉCNICAS

- Cilindro que se activa mediante presión, previene la apertura de la manilla y activa la alarma
- Ajustable individualmente, pasador cuadrado de seguridad, 32-44 mm de longitud
- Se puede igualar con la misma llave a una gran variedad de otros productos de la marca ABUS
- Integrada una alarma con una intensidad sonora de 110dBA (+/- 2dBA)
- Pilas alcalinas normales (2 unis AAA) duración aproximada 2 años
- Detector de rotura de vidrio disponible opcionalmente (GBM7300 W & B)
- Según DIN18267 clase 2
- Resistencia contra rotura de 200 Nm

Ref. No. Référence Referencia	EAN 4003318	Version Exécution Versión	Finish Coloris Color	Level Degré Nivel	Box Quantity Unité d'emballage Cantidad de cajas
FG300A B AAL0006	76794 4		brown	7	1
FG300A B AAL0054	76793 7		brown	7	1
FG300A B AL0089	76792 0		brown	7	1
FG300A B AL0125	71895 3		brown	7	1
FG300A B AL0145	71896 0		brown	7	1
FG300A W AAL0006	76791 3		white	7	1
FG300A W AAL0054	76790 6		white	7	1
FG300A W AL0089	76789 0		white	7	1
FG300A W AL0125	71899 1		white	7	1
FG300A W AL0145	71900 4		white	7	1
FG300A S AAL0006	76797 5		silver	7	1
FG300A S AAL0054	76796 8		silver	7	1
FG300A S AL0089	76795 1		silver	7	1
FG300A S AL0125	71904 2		silver	7	1
FG300A S AL0145	71905 9		silver	7	1
GBM7300 B SB	56986 9		brown		1
GBM7300 W SB	56985 2		white		1



# FG300

## LOCKABLE WINDOW HANDLE

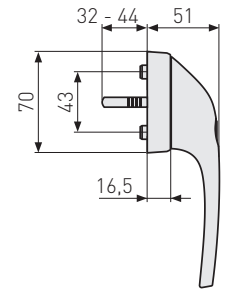
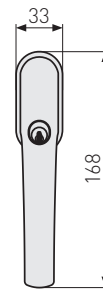

9N003

### TECHNOLOGY AND FEATURES

- Individually adjustable, secured square bolt
- 7 mm square bolt, distance of screws 43 mm
- DIN18267 class 2
- 200Nm resistance against pulling and tearing off
- Wear-resistant quadruple ball fastening
- Incl. two keys
- The activated push button cylinder prevents the opening of the window

### CARACTÉRISTIQUES TECHNIQUES

- Carré réglable individuellement, avec protection anti-arrachage, longueur 32-44 mm
- Tige carrée de 7 mm, écart entre les vis 43 mm
- DIN18267 classe 2
- Résistance de 200Nm contre arracher et éteindre
- Enclenchement boisseau quadruple sans usure
- Deux clés incluses
- Poignée et rosette en aluminium

### CARACTERÍSTICAS TÉCNICAS

- Ajustable individualmente, pasador cuadrado de seguridad, 32 - 44 mm de longitud
- Cuadradillo de 7 mm y distancia entre tornillos de 43 mm
- Según DIN 18267 clase 2
- Resistencia contra rotura de 200 Nm
- Enclavamiento esférico cuádruple de bajo desgaste
- Incluye 2 llaves
- El cierre mediante presión del cilindro previene la apertura malintencionada
- puede igualar con la misma llave a una gran variedad de otros productos de la marca ABUS

Ref. No. Référence Referencia	EAN 4003318	Version Exécution Versión	Finish Coloris Color	Level Degré Nivel	Box Quantity Unité d'emballage Cantidad de cajas
FG300 B AAL0006	37375 6		brown	5	2
FG300 B AAL0054	37376 3		brown	5	2
FG300 B AL0089	37372 5		brown	5	2
FG300 B AL0125	37373 2		brown	5	2
FG300 B AL0145	37374 9		brown	5	2
FG300 W vs. EK	37383 1		white	5	2
FG300 W AAL0006	37381 7		white	5	2
FG300 W AAL0054	37382 4		white	5	2
FG300 W AL0089	37378 7		white	5	2
FG300 W AL0125	37379 4		white	5	2
FG300 W AL0145	37380 0		white	5	2
FG300 S AAL0006	37387 9		silver	5	2
FG300 S AAL0054	37388 6		silver	5	2
FG300 S AL0089	37384 8		silver	5	2
FG300 S AL0125	37385 5		silver	5	2
FG300 S AL0145	37386 2		silver	5	2
FG300 ER-Look AL0089	89980 5		Stainless steel look	5	2
FG300 ER-Look AL0125	89945 4		Stainless steel look	5	2
FG300 ER-Look AL0145	89979 9		Stainless steel look	5	2

# FG110

## LOCKABLE WINDOW HANDLE



### TECHNOLOGY AND FEATURES

- 7 mm square bolt, distance of screws 43 mm
- Push button cylinder with reversible key
- Incl. one key, triples incl. three keys

### CARACTÉRISTIQUES TECHNIQUES

- Tige carrée de 7 mm, écart entre les vis de 43 mm
- Cylindre à pression avec clé réversible
- Une clé incluse, version Triples avec deux clés

### CARACTERÍSTICAS TÉCNICAS

- Cuadrado de 7 mm y distancia entre tornillos de 43 mm
- Cilindro a presión con llave reversible
- Incluye 1 llave, la versión triples incluye tres llaves

Ref. No. Référence Referencia	EAN 4003318	Version Exécution Versión	Finish Coloris Color	Level Degré Nivel	Box Quantity Unité d'emballage Cantidad de cajas
FG110 B CL/DFNLI	78753 9		brown	2	3
FG110 W CL/DFNLI	78755 3		white	2	3
FG110 S CL/DFNLI	78754 6		silver	2	3
FG110 B Triples CL/DFNLI	78750 8	3 keys, keyed alike	brown	2	2
FG110 W Triples CL/DFNLI	78752 2	3 keys, keyed alike	white	2	2
FG110 S Triples CL/DFNLI	78751 5	3 keys, keyed alike	silver	2	2



## HOMETEC PRO BLUETOOTH® DOOR LOCK DRIVE

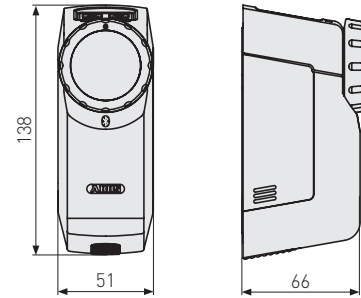

Product Video



### TECHNOLOGY AND FEATURES

- No special cylinder required – integration into existing lock system possible
- Suitable for Euro profile cylinders according to DIN 18252 and DIN EN 1303 with emergency function
- Cylinder protrusion of 7-12 mm on the inside of the door.
- Easy, flexible and wireless installation: clamp, glue or screw
- Fully automated drive programming
- Intelligent motor controller
- Maximum security through AES-128-bit encryption and ABUS Keycard
- Bluetooth® wireless standard
- Power supply by battery (4 x AA batteries included)
- suitable for Bluetooth®-enabled smartphones (Bluetooth® 4.0 LE and higher) with currently supported iOS or Android operating system
- Free ABUS app for iOS and Android
- The door lock drive is only compatible with products from the Bluetooth® 3100 product series from ABUS

### CARACTÉRISTIQUES TECHNIQUES

- Aucun cylindre spécial requis – possibilité d'intégration dans le système de fermeture existant
- Convient aux cylindres à profil européen selon DIN 18252 et DIN EN 1303 avec fonction débrayable
- Dépassement du cylindre de 7 à 12 mm à l'intérieur de la porte.
- Montage simple, flexible et sans câble : par pince, adhésif ou vis
- Programmation entièrement automatique du mécanisme
- Commande moteur intelligente
- Sécurité maximale grâce au cryptage AES-128 bits et à la Keycard ABUS
- Norme sans fil Bluetooth®
- Alimentation par pile (4 x piles AA ; incluses)
- convient aux smartphones compatibles Bluetooth® (Bluetooth® 4.0 LE et plus) avec le système d'exploitation iOS ou Android actuellement pris en charge
- Application ABUS gratuite pour iOS et Android
- Le mécanisme de serrure est uniquement compatible avec les produits de la série Bluetooth® 3100 d'ABUS

### CARACTERÍSTICAS TÉCNICAS

- No se requiere un cilindro especial, se puede integrar en un sistema de cierre ya existente
- Adecuado para cilindros de perfil europeo según DIN 18252 y DIN EN 1303 con función de emergencia y de peligro
- Protuberancia de cilindro de 7-12 mm en el lado interior de la puerta.
- Montaje sencillo, flexible y sin cables: fijación, pegado o atornillado
- Programación totalmente automática del accionamiento
- Control inteligente del motor
- Máxima seguridad gracias al cifrado AES de 128 bits y a la Keycard ABUS
- Estándar inalámbrico Bluetooth
- Alimentación de tensión por batería (se incluyen 4 baterías AA)
- apto para teléfonos inteligentes con Bluetooth® (Bluetooth® 4.0 LE y superior) con sistema operativo iOS o Android actualmente compatible
- Aplicación gratuita de ABUS para iOS y Android
- El accionamiento inalámbrico de cerradura de puerta solo es compatible con los productos de la serie de productos Bluetooth® 3100 de ABUS

Ref. No. Référence Referencia	EAN 4003318	Variants Exécutions Variantes	Finish Coloris Color	Box Quantity Unité d'emballage Cantidad de cajas
HomeTec Pro CFA3100BK	91693 9	Bluetooth® Door Lock Drive	black	1
HomeTec Pro CFA3100W	88311 8	Bluetooth® Door Lock Drive	white	1
HomeTec Pro CFA3100S	88312 5	Bluetooth® Door Lock Drive	silver	1

## HOMETEC PRO BLUETOOTH®- KEYPAD

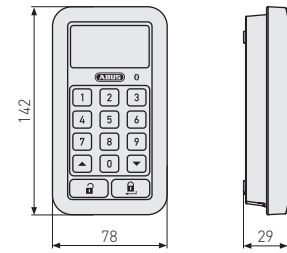

### TECHNOLOGY AND FEATURES

- Backlight display with high-quality touch surface
- Straightforward, flexible and cable-free installation
- Maximum security through AES-128-bit encryption and ABUS Keycard
- Bluetooth® wireless standard
- Power supply by battery (4 x AA batteries included)
- The door lock drive HomeTec Pro Bluetooth® CFA3100 is required

### CARACTÉRISTIQUES TECHNIQUES

- Écran rétroéclairé à surface tactile de qualité
- Montage simple, flexible et sans câble
- Sécurité maximale grâce au cryptage AES-128 bits et la Keycard ABUS
- Norme sans fil Bluetooth®
- Alimentation par pile (4 x piles AA ; incluses)
- Le mécanisme de serrure HomeTec Pro Bluetooth® CFA3100 est nécessaire

### CARACTERÍSTICAS TÉCNICAS

- Pantalla retroiluminada con superficie táctil de gran calidad
- Montaje sencillo, flexible y sin cables
- Máxima seguridad gracias al cifrado AES de 128 bits y a la Keycard ABUS
- Estándar inalámbrico Bluetooth
- Alimentación de tensión por batería (se incluyen 4 baterías AA)
- Es necesario el accionamiento inalámbrico de cerradura de puerta HomeTec Pro Bluetooth® CFA3100

Ref. No. Référence Referencia	EAN 4003318	Variants Exécutions Variantes	Finish Coloris Color	Box Quantity Unité d'emballage Cantidad de cajas
HomeTec Pro CFT3100S	88314 9	Bluetooth® Keypad	silver	1
HomeTec Pro CFT3100W	88313 2	Bluetooth® Keypad	white	1

## HOMETEC PRO BLUETOOTH® REMOTE CONTROL

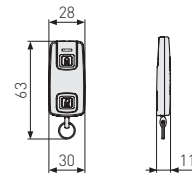

### TECHNOLOGY AND FEATURES

- Drive status can be requested
- Activate up to two drives at once
- Maximum security through AES-128-bit encryption and ABUS Keycard
- Bluetooth® wireless standard
- Power supply by battery (1 x 3V button cell CR2032 included)
- The door lock drive HomeTec Pro Bluetooth® CFA3100 is required

### CARACTÉRISTIQUES TECHNIQUES

- Consultation de l'état du mécanisme
- Commande simultanée de deux mécanismes
- Sécurité maximale grâce au cryptage AES-128 bits et à la Keycard ABUS
- Norme sans fil Bluetooth®
- Alimentation par pile (1 x 3V pile bouton CR2032 ; incluse)
- Le mécanisme de serrure HomeTec Pro Bluetooth® CFA3100 est nécessaire

### CARACTERÍSTICAS TÉCNICAS

- Posibilidad de consultar el estado del accionamiento
- Admite el control de gasta dos accionamientos al mismo tiempo
- Máxima seguridad gracias al cifrado AES de 128 bits y a la Keycard ABUS
- Estándar inalámbrico Bluetooth
- Alimentación de tensión por batería (se incluye 1 pila de botón de 3V CR2032)
- Es necesario el accionamiento inalámbrico de cerradura de puerta HomeTec Pro Bluetooth® CFA3100

Ref. No. Référence Referencia	EAN 4003318	Variants Exécutions Variantes	Finish Coloris Color	Box Quantity Unité d'emballage Cantidad de cajas
HomeTec Pro CFF3100	88315 6	Bluetooth® Remote Control	black	1

## HOMETEC PRO BLUETOOTH® FINGER SCANNER

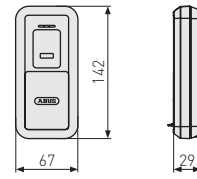

### TECHNOLOGY AND FEATURES

- Memory for 28 different fingerprints
- Straightforward, flexible and cable-free installation
- Maximum security through AES-128-bit encryption and ABUS Keycard
- Bluetooth® wireless standard
- Power supply via battery (3 x AA batteries; included)
- The door lock drive HomeTec Pro Bluetooth® CFA3100 is required



### CARACTÉRISTIQUES TECHNIQUES

- Mémoire pour 28 doigts différents
- Montage simple, flexible et sans câble
- Sécurité maximale grâce au cryptage AES-128 bits et à la Keycard ABUS
- Norme sans fil Bluetooth®
- Alimentation par pile (3 x piles AA ; incluses)
- Le mécanisme de serrure HomeTec Pro Bluetooth® CFA3100 est nécessaire

### CARACTERÍSTICAS TÉCNICAS

- Memoria para 28 dedos diferentes
- Montaje sencillo, flexible y sin cables
- Máxima seguridad gracias al cifrado AES de 128 bits y a la Keycard ABUS
- Estándar inalámbrico Bluetooth
- Fuente de alimentación con pilas (3 pilas AA; incluidas)
- Es necesario el accionamiento inalámbrico de cerradura de puerta HomeTec Pro Bluetooth® CFA3100

Ref. No. Référence Referencia	EAN 4003318	Variants Exécutions Variantes	Finish Coloris Color	Box Quantity Unité d'emballage Cantidad de cajas
HomeTec Pro CFS3100W	40506 8	Bluetooth® Finger Scanner	white	1
HomeTec Pro CFS3100S	05478 5	Bluetooth® Finger Scanner	silver	1

## HOMETEC PRO BLUETOOTH® WI-FI BRIDGE

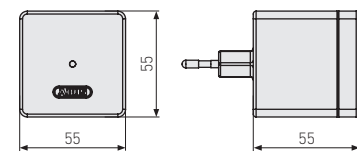

### TECHNOLOGY AND FEATURES

- IEEE 802.11 b/g/n Wi-Fi network (2,4 GHz)
- Internet connection required
- Open socket (230V), max. 5 metres from the door lock drive
- The door lock drive HomeTec Pro Bluetooth®CFA3100 is required

### CARACTÉRISTIQUES TECHNIQUES

- Réseau Wi-Fi IEEE 802.11 b/g/n (2,4 GHz)
- Connexion Internet nécessaire
- Prise (230 V), distance max. de 5 mètres par rapport au mécanisme de serrure
- Le mécanisme de serrure HomeTec Pro Bluetooth®CFA3100 est nécessaire

### CARACTERÍSTICAS TÉCNICAS

- IEEE 802.11 b/g/n red WLAN (2,4 GHz)
- Conexión a Internet necesaria
- Enchufe libre (230 V), distancia máx. de 5 metros hasta el accionamiento inalámbrico de cerradura de puerta
- Es necesario el accionamiento inalámbrico de cerradura de puerta HomeTec Pro Bluetooth®CFA3100



Ref. No. Référence Referencia	EAN 4003318	Variants Exécutions Variantes	Finish Coloris Color	Box Quantity Unité d'emballage Cantidad de cajas
HomeTec Pro CFW3100W	88316 3	Bluetooth® Wi-Fi Bridge	white	1

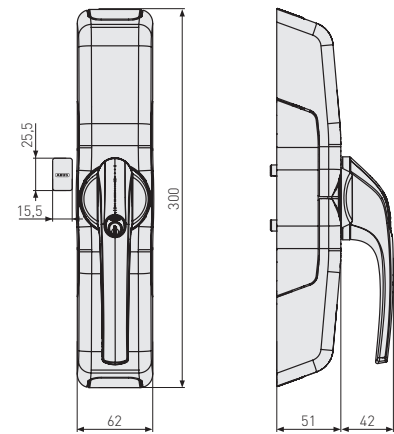

### TECHNOLOGY AND FEATURES

- Optimum ease of use thanks to optional wireless remote control and/or wireless keypad
- Maximum security through AES 128 bit encryption
- 3D alarm sensor system triggers a 110 dBA alarm as soon as a break-in attempt is detected
- Fully automatic pairing of the power unit
- Mechanical closing remains possible, electronic control works even when the locking cylinder is pressed in thanks to dual drive

### CARACTÉRISTIQUES TECHNIQUES

- Confort d'utilisation ultime grâce à la télécommande et/ou au clavier sans fil en option
- Sécurité maximale grâce au cryptage AES 128 bits
- Capteurs d'alarme 3D avec alarme de 110 dBA dès la tentative d'effraction
- Programmation entièrement automatique de l'entraînement
- Fonction de fermeture mécanique conservée, commande électronique qui fonctionne également en cas de cylindre de serrure enfoncé grâce à une double transmission

### CARACTERÍSTICAS TÉCNICAS

- Máxima comodidad en el uso gracias al control remoto inalámbrico y/o teclado opcionales
- Máxima seguridad gracias al cifrado AES de 128 bit
- El sistema de sensores 3D se dispara ante los intentos de intrusión con una alarma de 110 dBA
- Programación totalmente automática del accionamiento
- La función de cierre mecánico sigue siendo posible, y el control electrónico funciona incluso con el cilindro de cierre presionado gracias al accionamiento dual

Ref. No. Référence Referencia	EAN 4003318	Variants Exécutions Variantes	Finish Coloris Color	Box Quantity Unité d'emballage Cantidad de cajas
FCA3000 B vs.	84108 8	with Alarm	brown	1
FCA3000 B AAL0006	84102 6	with Alarm	brown	1
FCA3000 B AAL0054	84103 3	with Alarm	brown	1
FCA3000 B AL0089	84104 0	with Alarm	brown	1
FCA3000 B AL0125	84105 7	with Alarm	brown	1
FCA3000 B AL0145	84106 4	with Alarm	brown	1
FCA3000 W vs.	79809 2	with Alarm	white	1
FCA3000 W AAL0006	76917 7	with Alarm	white	1
FCA3000 W AAL0054	76919 1	with Alarm	white	1
FCA3000 W AL0089	79807 8	with Alarm	white	1
FCA3000 W AL0125	79805 4	with Alarm	white	1
FCA3000 W AL0145	79806 1	with Alarm	white	1
FCA3000 S vs.	79815 3	with Alarm	silver	1
FCA3000 S AAL0006	76920 7	with Alarm	silver	1
FCA3000 S AAL0054	79810 8	with Alarm	silver	1
FCA3000 S AL0089	79813 9	with Alarm	silver	1
FCA3000 S AL0125	79811 5	with Alarm	silver	1
FCA3000 S AL0145	79812 2	with Alarm	silver	1
CFT3000 W	10125 0	Radio Keypad	white	1
CFT3000 S	10126 7	Radio Keypad	silver	1
CSS3000 W	73362 8	Visual Cover Radio Keypad	white	1
CSS3000 S	73361 1	Visual Cover Radio Keypad	silver	1
CFF3000	10127 4	Radio Remote Control	silver	1



## ABOUT ABUS SECURITY CENTER GMBH & CO. KG

ABUS Security Center is a manufacturer of innovative alarm and video surveillance systems as well as electronic access control systems.

The wholly owned subsidiary of the ABUS KG has specialised in the security requirements of small and medium-sized businesses and private users since 1999.

We focus on developing particularly user-friendly products for all-round security, blending mechanical, electronic, alarm, video technology and access control.

Our range encompasses surveillance cameras and digital video surveillance recorders, including hybrid solutions which allow proven analogue camera technology and the very latest network cameras to work in harmony in one system.

Our range of wireless and wired alarm systems along with the integration of video and mechatronic components sets new standards for alarm systems.



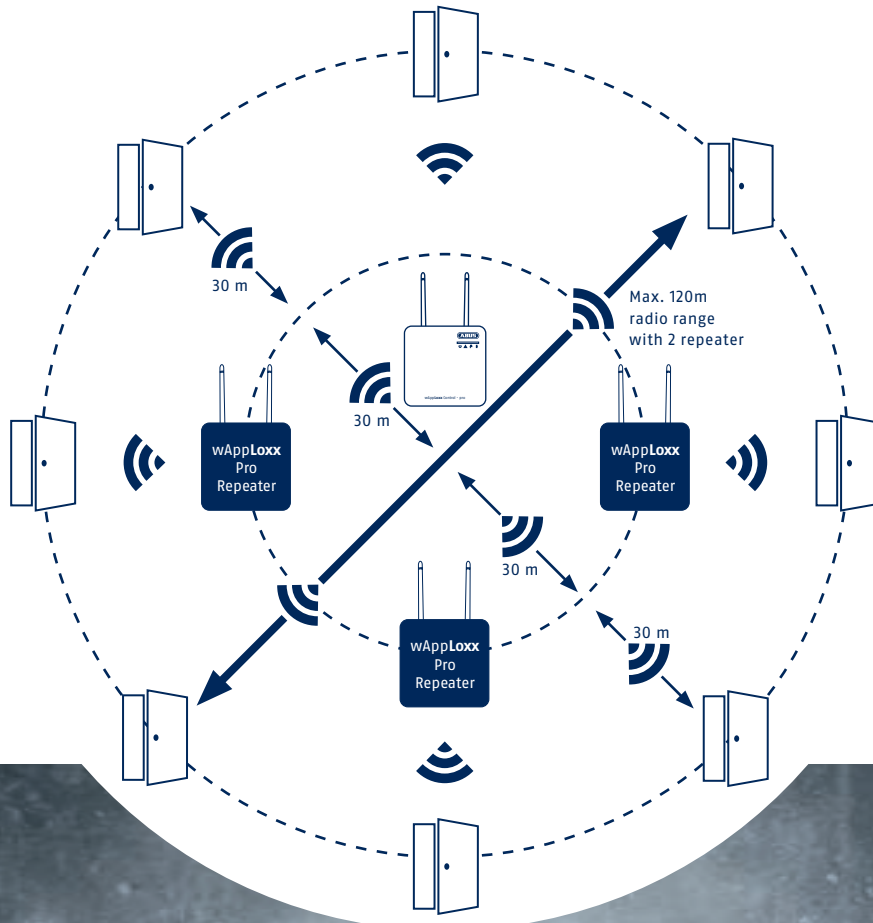



**PRIVACY INDOOR CAMERA  
PPIC31020**



**PAN/TILT OUTDOOR CAMERA  
PPIC42520**



**OUTDOOR CAMERA  
PPIC44520**



## ABUS WI-FI ADDITIONAL BATTERY CAM



PPIC90000

PPIC90200



PPIC90520



PPIC90010

### TECHNOLOGY AND FEATURES

- Access via ABUS Wi-Fi base station for battery cam and App2Cam Plus
- 100% wireless thanks to battery and Wi-Fi/radio technology
- 2.4 GHz Wi-Fi and encrypted transmission
- Long-lasting battery and 4-hour fast-charge mode
- White light LED and high-performance chip set
- Full HD 1080p/2MPx
- 120° angle of vision (150° diagonal)
- Stand-by mode and hardware PIR-controlled activation
- PIR angle of view 112° and PIR range 8m
- Integrated loudspeaker and microphone
- Horizontal camera design
- Fixed screw connections on wall and camera holder (no magnetic holder)

### CARACTÉRISTIQUES TECHNIQUES

- Accès via la station de base Wi-Fi ABUS pour caméra avec batterie intégrée et App2Cam Plus
- Sans câble grâce à la technologie batterie et radio/Wi-Fi
- Wi-Fi 2,4 GHz & transmission cryptée
- Batterie longue durée & charge rapide 4h
- LED à lumière blanche et chipset haute performance
- Full HD 1080p/2MPx
- Angle de vue de 120° (diagonale 150°)
- Mode veille et activation PIR
- Angle de vue PIR 112° et portée PIR 8 m
- Haut-parleur et microphone intégrés
- Design caméra horizontal
- Montage à vis au niveau du support mural et caméra (pas de support magnétique)

### CARACTERÍSTICAS TÉCNICAS

- Acceso a través de la unidad principal ABUS WLAN para cámara con batería y de la aplicación App2Cam Plus
- 100 % libre de cables gracias a la tecnología de baterías y el sistema WLAN/inalámbrico
- WLAN de 2,4 GHz y sistema inalámbrico codificado
- Luz LED blanca y circuito integrado auxiliar de alto rendimiento
- Full HD 1080p/2 MPx
- Ángulo de visión de 120° (diagonal 150°)
- Modo stand-by y activación de hardware mediante PIR
- Ángulo de visión PIR de 112° y alcance PIR de 8 m
- Altavoz y micrófono integrados
- Diseño de la cámara horizontal
- Conexiones atornilladas estables en el soporte mural y de la cámara (sin soportes magnéticos)

Ref. No. Référence Referencia	EAN 4003318	Variants Exécutions Variantes	Finish Coloris Color	Box Quantity Unité d'emballage Cantidad de cajas
PPIC90000	87913 5	Camera + Base Station	white	1
PPIC90200	87915 9	2x Camera + Base Station	white	1
PPIC90520	87916 6	Battery-Cam	white	1
PPIC90010	87914 2	Base Station	white	1

# PPIC32020

## ABUS SMART SECURITY WORLD WI-FI PAN/TILT INDOOR CAMERA

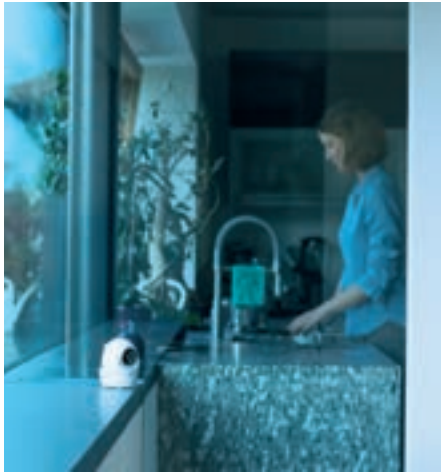

### TECHNOLOGY AND FEATURES

- Full HD 1080p resolution and infrared night vision function for brilliant image quality
- Recording to SD card with up to 128 GB (accessory)
- Direct notifications via email and push service as well as automatic recording when you have set up
- motion detection
- Fewer false alarms thanks to adjustable motion screen
- Guided step-by-step installation via the app (iOS, Android)
- Integrated microphone and loudspeaker for two-way communication via the app
- Low network load thanks to high data compression (H.264 High Profile compression)
- Also usable as „stand-alone“

### CARACTÉRISTIQUES TECHNIQUES

- Résolution Full HD 1 080 p et fonction infrarouge de vision nocturne pour une qualité d'image exceptionnelle
- Enregistrement sur carte SD avec jusqu'à 128 Go (accessoire)
- Notification directe par e-mail et service push ainsi qu'enregistrement automatique en cas de
- détection de mouvement configurée
- Réduction des fausses alarmes grâce à un masque de mouvement réglable
- Installation guidée pas à pas par application (iOS, Android)
- Microphone intégré et haut-parleur pour communication par application
- Faible charge du réseau grâce à l'importante compression de données (compression H.264 High Profile)
- Également utilisable en version autonome

### CARACTERÍSTICAS TÉCNICAS

- Resolución Full HD 1080p y función de visión nocturna por infrarrojos para una excelente calidad de imagen
- Grabación en tarjeta SD de hasta 128 GB (accesorio)
- Notificación directa por e-mail y servicios Push, así como grabación automática por detección con la
- detección de movimiento configurada
- Reducción de falsas alarmas gracias a máscara de movimiento ajustable
- Instalación guiada paso a paso mediante aplicación (iOS, Android)
- Micrófono integrado y altavoces para intercomunicación por aplicación
- Carga mínima de la red gracias a datos muy comprimidos (compresión excepcional H.264)
- Posibilidad de uso también como dispositivo autónomo

Ref. No. Référence Referencia	EAN 4003318	Variants Exécutions Variantes	Finish Coloris Color	Box Quantity Unité d'emballage Cantidad de cajas
PPIC32020	79650 0	Wi-Fi Pan/Tilt Indoor Camera	white	1
TVAC17520	71723 9	Signal Amplification Kit		1

# PPIC34520

## ABUS SMART SECURITY WORLD WI-FI TUBE CAMERA



### TECHNOLOGY AND FEATURES

- Full HD 1080p resolution and infrared night vision function for brilliant image quality
- Recording to SD card with up to 128 GB (accessory)
- Direct notifications via email and push service as well as automatic recording when you have set up
- motion detection
- Professional motion detection for outdoor use (integrated PIR sensor)
- Guided step-by-step installation via app (iOS, Android)
- Integrated microphone for listening via the app (can be turned off)
- Low network load thanks to high data compression (H.264 High Profile compression)
- Also usable as „stand-alone“

### CARACTÉRISTIQUES TECHNIQUES

- Résolution Full HD 1 080 p et fonction infrarouge de vision nocturne pour une qualité d'image exceptionnelle
- Enregistrement sur carte SD avec jusqu'à 128 Go (accessoire)
- Notification directe par e-mail et service push ainsi qu'enregistrement automatique en cas de
- détection de mouvement configurée
- Détection de mouvement professionnelle pour l'extérieur (capteur PIR intégré)
- Installation guidée pas à pas par application (iOS, Android)
- Microphone intégré pour entendre par application (désactivable)
- Faible charge du réseau grâce à l'importante compression de données (compression H.264 High Profile)
- Également utilisable en version autonome

### CARACTERÍSTICAS TÉCNICAS

- Resolución Full HD 1080p y función de visión nocturna por infrarrojos para una excelente calidad de imagen
- Grabación en tarjeta SD de hasta 128 GB (accesorio)
- Notificación directa por e-mail y servicios Push, así como grabación automática por detección con la
- detección de movimiento configurada
- Detección de movimiento profesional para exteriores (tipo de sensor PIR integrado)
- Instalación guiada paso a paso mediante aplicación (iOS, Android)
- Micrófono integrado para escuchar mediante aplicación (desconectable)
- Carga mínima de la red gracias a datos muy comprimidos (compresión excepcional H.264)
- Posibilidad de uso también como dispositivo autónomo

Ref. No. Référence Referencia	EAN 4003318	Variants Exécutions Variantes	Finish Coloris Color	Box Quantity Unité d'emballage Cantidad de cajas
PPIC34520	79651 7	Wi-Fi Tube Camera	white	1
TVAC17520	71723 9	Signal Amplification Kit		1

## ABUS SMART SECURITY WORLD WI-FI CAMERA WITH LIGHT

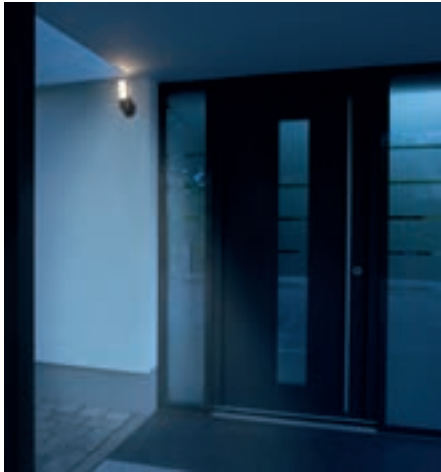

### TECHNOLOGY AND FEATURES

- Full HD 1080p resolution with wide angle (120°) and infrared night vision function for brilliant image quality
- High-performance LED with up to 950 lumen (light intensity can be set individually)
- Integrated microphone and loudspeaker for two-way communication via the app
- Existing cable connections to replace outdoor lighting
- Professional motion detection for outdoor use (integrated PIR sensor)
- Sturdy weatherproof camera housing (IP55)
- Guided step-by-step installation via the app (iOS, Android)
- Recording to SD card with up to 128 GB (accessory)
- Direct notifications via email and push service as well as automatic recording when you have set up motion detection
- Also usable as „stand-alone“

### CARACTÉRISTIQUES TECHNIQUES

- Résolution Full HD 1 080 p grand angle (120°) et fonction infrarouge de vision nocturne pour une qualité d'image exceptionnelle
- LED haute performance jusqu'à 950 Lumen (intensité lumineuse à réglage individuel)
- Microphone intégré et haut-parleur pour communication par application
- Raccordements de câbles existants pour remplacement d'une lampe extérieure
- Détection de mouvement professionnelle pour l'extérieur (capteur PIR intégré)
- Boîtier de caméra robuste, résistant aux intempéries (IP55)
- Installation guidée pas à pas par application (iOS, Android)
- Enregistrement sur carte SD avec jusqu'à 128 Go (accessoire)
- Notification directe par e-mail et service push
- ainsi qu'enregistrement automatique en cas de détection de mouvement configurée
- Également utilisable en version autonome

### CARACTERÍSTICAS TÉCNICAS

- Resolución Full HD 1080p con gran angular (120°) y función de visión nocturna por infrarrojos para una calidad de imagen brillante
- LED de alto rendimiento con hasta 950 lúmenes (intensidad de la luz ajustable individualmente)
- Micrófono integrado y altavoces para intercomunicación por aplicación
- Conexiones de cable disponibles para sustituir una luz exterior
- Detección de movimiento profesional para exteriores (sensor PIR integrado)
- Carcasa de la cámara robusta y resistente a la intemperie (IP55)
- Instalación guiada paso a paso mediante aplicación (iOS, Android)
- Grabación en tarjeta SD de hasta 128 GB (accessorio)
- Notificación directa por e-mail y servicios Push, así como grabación automática con la detección de movimiento configurada
- Posibilidad de uso también como dispositivo autónomo

Ref. No. Référence Referencia	EAN 4003318	Variants Exécutions Variantes	Finish Coloris Color	Box Quantity Unité d'emballage Cantidad de cajas
PPIC36520	82655 9	Wi-Fi Camera with Light	white	1
TVAC17520	71723 9	Signal Amplification Kit		1

# PPDF14520

## ONELOOK OUTDOOR CAMERA



### TECHNOLOGY AND FEATURES

- Compact full HD 1080p wireless outdoor camera (IP66)
- Video and audio transmitted via encrypted digital radio
- Includes PIR sensor for reliable motion detection
- Full HD 1080p resolution and infrared night vision function for brilliant image quality
- Can be used as an extension for the PPDF16000 wireless home video sets (PPDF16000, PPDF18000)
- Up to four wireless cameras can be used with each monitor/recorder

### CARACTÉRISTIQUES TECHNIQUES

- Caméra extérieure sans fil compacte Full HD 1 080 p (IP66)
- Transmission des fichiers vidéo et audio par liaison sans fil numérique cryptée
- Capteur PIR inclus pour une détection de mouvement fiable
- Résolution Full HD 1 080 p et fonction infrarouge de vision nocturne pour une qualité d'image exceptionnelle
- Utilisable en extension des kits vidéo privés sans fil (PPDF16000, PPDF18000)
- Jusqu'à 4 caméras sans fil utilisables pour chaque écran/enregistreur

### CARACTERÍSTICAS TÉCNICAS

- Cámara inalámbrica compacta para exterior con resolución Full HD 1080p (IP66)
- Transmisión de vídeo y audio mediante radiocomunicación digital codificada
- Incluye sensor PIR para detección de movimiento fiable
- Resolución Full HD 1080p y función de visión nocturna por infrarrojos para una excelente calidad de imagen
- Se puede utilizar para ampliar el kit inalámbrico de video-vigilancia doméstica (PPDF16000, PPDF18000)
- Utilización de hasta 4 cámaras inalámbricas por monitor/grabadora

Ref. No. Référence Referencia	EAN 4003318	Variants Exécutions Variantes	Finish Coloris Color	Box Quantity Unité d'emballage Cantidad de cajas
PPDF14520	80024 5	OneLook Outdoor Camera	black	1
PPDF14520 W	82242 1	OneLook Outdoor Camera	white	1

# PPDF16000

## ABUS ONELOOK SURVEILLANCE SET



### TECHNOLOGY AND FEATURES

- Complete set consisting of a full HD 1080p wireless outdoor camera (IP66) and 7" monitor
- Video and audio transmitted via encrypted digital radio
- Outdoor camera with PIR sensor for reliable motion detection
- Full HD 1080p resolution and infrared night vision function for brilliant image quality
- 7" colour monitor with integrated loudspeaker and battery capacity for up to 2 hours of mobile use
- Recording to SD card with up to 128 GB (accessory)
- Recording to external USB hard disk with up to 2 TB (accessory)
- Easy operation via touchscreen and user-friendly control menu
- Mobile access via free app
- User-friendly, intuitive setup of remote access to the camera (LAN connection required)

### CARACTÉRISTIQUES TECHNIQUES

- Kit complet comprenant une caméra extérieure sans fil Full HD 1 080 p (IP66) et un écran 7"
- Transmission des fichiers vidéo et audio par liaison sans fil numérique cryptée
- Caméra extérieure avec capteur PIR pour une détection de mouvement fiable
- Résolution Full HD 1 080 p et fonction infrarouge de vision nocturne pour une qualité d'image exceptionnelle
- Écran couleur 7" avec haut-parleur intégré et batterie permettant jusqu'à 2 heures de fonctionnement mobile
- Enregistrement sur carte SD avec jusqu'à 128 Go (accessoire)
- Enregistrement sur un disque dur USB externe avec jusqu'à 2 To (accessoire)
- Utilisation simple grâce à l'écran tactile et au menu de commande convivial
- Accès mobile par application gratuite
- Configuration conviviale et intuitive d'un accès à distance à la caméra (connexion LAN nécessaire)

### CARACTERÍSTICAS TÉCNICAS

- Kit completo con cámara inalámbrica para exteriores Full HD 1080p (IP66) y monitor de 7"
- Transmisión de vídeo y audio mediante radiocomunicación digital codificada
- Cámara para exterior con sensor PIR para detección de movimiento fiable
- Resolución Full HD 1080p y función de visión nocturna por infrarrojos para una excelente calidad de imagen
- Monitor en color de 7" con altavoz integrado y batería para hasta 2 horas de autonomía para uso móvil
- Grabación en tarjeta SD de hasta 128 GB (accesorio)
- Grabación en disco duro externo USB de hasta 2 TB (accesorio)
- Manejo sencillo mediante la pantalla táctil y menú de manejo intuitivo
- Acceso móvil mediante la aplicación gratuita
- Instalación intuitiva y sencilla de un acceso remoto a la cámara (es necesaria una conexión LAN)

Ref. No. Référence Referencia	EAN 4003318	Variants Exécutions Variantes	Finish Coloris Color	Box Quantity Unité d'emballage Cantidad de cajas
PPDF16000	80023 8	OneLook Vidéo Surveillance Set	black	1





### TECHNOLOGY AND FEATURES

- Complete set consisting of a full HD 1080p wireless outdoor camera (IP66) and recorder
- Video and audio transmitted via encrypted digital radio
- Outdoor camera with PIR sensor for reliable motion detection
- Full HD 1080p resolution and infrared night vision function for brilliant image quality
- HDMI interface for displaying and configuring using a monitor
- Up to one month of continuous recording with up to 2 TB external hard disk drive (accessory)
- Mobile access via free app
- User-friendly, intuitive setup of remote access to the camera (LAN connection required)
- Can be extended to include up to three wireless cameras (item number: PPDF14520, PPDF14520W)
- Micro SD 8 GB included with delivery, up to 128 GB supported
- Single/Quad/Smart Quad output
- Recording: manual, motion, time schedule

### CARACTÉRISTIQUES TECHNIQUES

- Kit complet comprenant une caméra extérieure sans fil Full HD 1 080 p (IP66) et un enregistreur
- Transmission des fichiers vidéo et audio par liaison sans fil numérique cryptée
- Caméra extérieure avec capteur PIR pour une détection de mouvement fiable
- Résolution Full HD 1 080 p et fonction infrarouge de vision nocturne pour une qualité d'image exceptionnelle
- Interface HDMI pour l'affichage et la configuration sur un écran
- Enregistrement continu jusqu'à 1 mois avec disque dur externe jusqu'à 2 To (accessoire)
- Accès mobile par application gratuite
- Configuration conviviale et intuitive d'un accès à distance à la caméra (connexion LAN nécessaire)
- Extensible avec jusqu'à 3 caméras sans fil (No d'article : PPDF14520, PPDF14520W)
- Carte microSD 8 Go comprise dans la livraison, jusqu'à 128 Go pris en charge
- Sortie Single/Quad/Smart Quad
- Enregistrement : manuel, mouvement, selon planning

### CARACTERÍSTICAS TÉCNICAS

- Kit completo con cámara inalámbrica para exteriores Full HD 1080p (IP66) y grabadora
- Transmisión de vídeo y audio mediante radiocomunicación digital codificada
- Cámara para exterior con sensor PIR para detección de movimiento fiable
- Resolución Full HD 1080p y función de visión nocturna por infrarrojos para una excelente calidad de imagen
- Puerto HDMI para visualización y configuración de un monitor
- Grabación continua de hasta 1 mes con disco duro externo de hasta 2 TB (accesorios)
- Acceso móvil mediante la aplicación gratuita
- Instalación intuitiva y sencilla de un acceso remoto a la cámara (es necesaria una conexión LAN)
- Ampliable hasta 3 cámaras inalámbricas (n.º ref.: PPDF14520, PPDF14520W)
- MicroSD 8 GB en el volumen de entrega, admite hasta 128 GB
- Salida Single/Quad/Smart Quad
- Grabación: manual, movimiento, programación

Ref. No. Référence Referencia	EAN 4003318	Variants Exécutions Variantes	Finish Coloris Color	Box Quantity Unité d'emballage Cantidad de cajas
PPDF18000	82241 4	OneLook Surveillance System	white	1
PPDF14520 W	82242 1	OneLook Outdoor Camera	white	1
PPDF14520	80024 5	OneLook Outdoor Camera	black	1
TVAC17520	71723 9	Signal Amplification Kit		1

# TVAC17520

## SIGNAL AMPLIFICATION KIT



### TECHNOLOGY AND FEATURES

- Complete kit including 5 dB antenna, wall mount and 2 m cable
- Ideal for improving signal strength and extending the range of wireless and Wi-Fi cameras
- Sturdy wall mount and weather protected cable and antenna
- Suitable for TVAC14010, TVAC15010, TVAC1601x, TVAC18010, TVAC19x00, PPI3xxxx, PPDF1xxxx

### CARACTÉRISTIQUES TECHNIQUES

- Kit complet avec antenne 5 dB, support mural et câble de 2 m
- Idéal pour l'amplification des signaux et l'extension de la portée des caméras sans fil et Wi-Fi
- Support mural robuste, câble et antenne protégés contre les intempéries
- Compatible avec TVAC14010, TVAC15010, TVAC1601x, TVAC18010, TVAC19x00, PPI3xxxx, PPDF1xxxx

### CARACTERÍSTICAS TÉCNICAS

- Kit completo con antena de 5 dB, soporte de pared y cable de 2 m
- Idóneo para intensificar la señal y aumentar el alcance de las cámaras WLAN e inalámbricas
- Soporte de pared robusto y cable y antena resistentes a la intemperie
- Apto para TVAC14010, TVAC15010, TVAC1601x, TVAC18010, TVAC19x00, PPI3xxxx, PPDF1xxxx

Ref. No. Référence Referencia	EAN 4003318	Variants Exécutions Variantes	Finish Coloris Color	Box Quantity Unité d'emballage Cantidad de cajas
TVAC17520	71723 9	Signal Amplification Kit		1

# TVAC47030

## POWER EXTENSION CABLE 3M



### TECHNOLOGY AND FEATURES

- Pre-assembled extension cable for DC plug 3.5 x 1.35 mm
- Suitable for all ABUS Smart Security World cameras
- Flexible installation of cameras
- Length 3 m

### CARACTÉRISTIQUES TECHNIQUES

- Rallonge prête à l'emploi pour connecteur CC 3,5 x 1,35 mm
- Convient pour toutes les caméras ABUS Smart Security World
- Installation flexible de caméras
- Longueur 3 m

### CARACTERÍSTICAS TÉCNICAS

- Cable alargador premontado para enchufe macho CC 3,5 x 1,35 mm
- Compatible con todas las cámaras ABUS Smart Security World
- Instalación flexible de las cámaras
- Longitud de 3 m

Ref. No. Référence Referencia	EAN 4003318	Variants Exécutions Variantes	Finish Coloris Color	Box Quantity Unité d'emballage Cantidad de cajas
TVAC47030	87912 8	Power Extension Cable 3 m		1



# 620TSA

## LUGGAGE STRAP



### TECHNOLOGY AND FEATURES

- Luggage strap lock can be adjusted to suitcases with different sizes temporary and flexibly
- Individually resettable 3-digit code
- Writeable address label included
- Total length of luggage strap - ca. 192 cm
- Inclusive opening indicator showing that the luggage strap was opened by a TSA key

### CARACTÉRISTIQUES TECHNIQUES

- Sangle à bagage flexible et adaptable à diverses tailles de bagage
- Code à 3 chiffres personnalisable
- Étiquette d'adresse personnalisable incluse
- Longueur totale de la sangle : env. 192 cm
- Avec indicateur d'ouverture indiquant si la sangle à bagage a été ouverte à l'aide d'une clé TSA

### CARACTERÍSTICAS TÉCNICAS

- La cinta para maleta se adapta de forma flexible a distintos tamaños de maleta
- Código numérico personalizable de 3 cifras
- Incluye etiqueta para dirección
- Longitud total de la cinta - aprox. 192 cm
- Incluye indicador de apertura que muestra si la cinta para maleta se ha abierto con una llave TSA

Ref. No. Référence Referencia	EAN 4003318	Variants Exécutions Variantes	Finish Coloris Color	Box Quantity Unité d'emballage Cantidad de cajas
620TSA/192 blue	87661 5		blue	1
620TSA/192 green	87659 2		green	1
620TSA/192 red	87660 8		red	1
620TSA/192 black	87658 5		black	1

## TORCH



### TECHNOLOGY AND FEATURES

- When travelling, small, light, robust and does not take up much space in your luggage
- Modes: High Power - Low Power - Off
- Light time: High Power approx. 2.5 hours, Eco Mode 5 hours
- Range: High Mode 150 m, Low Mode 80m
- IP Class: IP 44 (splash-proof)
- Material: Aluminium with plastic handle
- Bag: High quality tensile nylon with carabiner
- White light: LED
- incl. batteries: 2 x AA

### CARACTÉRISTIQUES TECHNIQUES

- En voyage, il est petit, léger, robuste et ne prend pas beaucoup de place dans vos bagages
- Modes : High Power - Low Power - Off
- Durée d'éclairage : Haute puissance : environ 2,5 heures, mode Eco : 5 heures
- Portée : High Mode 150 m, Low Mode 80m
- Classe IP : IP 44 (protégée contre les projections d'eau)
- Matériau : aluminium avec poignée en plastique
- Sac : Nylon de haute qualité avec mousqueton
- Lumière blanche : LED
- piles incluses : 2 x AA

### CARACTERÍSTICAS TÉCNICAS

- Perfecta para viajar, pues es pequeña, ligera, robusta y no ocupa mucho espacio en el equipaje
- Modos: potencia alta, potencia Low, off
- Tiempo de iluminación: 2,5 horas con potencia alta, 5 horas con modo Eco
- Alcance: High Mode 150 m, Low Mode 80m
- Clase IP: IP 44 (a prueba de salpicaduras)
- Material: aluminio con mango de plástico
- Bolsa: nylon de alta calidad con mosquetón
- Luz blanca: LED
- Incluye baterías: 2 x AA

Ref. No. Référence Referencia	EAN 4003318	Variants Exécutions Variantes	Finish Coloris Color	Box Quantity Unité d'emballage Cantidad de cajas
TL-515	91916 9	Torch 15.1 cm		1

# TL- 517

## TORCH

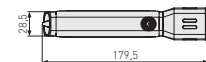

### TECHNOLOGY AND FEATURES

- Lumen: 450
- Modes: High Power - Medium Power - Red Light - Off - Stroboscope
- Light time: High Power approx. 2 hours, Low Power approx. 4 hours
- Range: 200 m; with zoom function (change light beam)
- IP Class: IP 44 (splash-proof)
- Material: Aluminium with plastic handle
- Bag: 1680D nylon; loop: high quality double loop
- White light: LED, red light: 3 W
- incl. battery: 4 x AAA

### CARACTÉRISTIQUES TECHNIQUES

- Lumen : 450
- Modes : Haute puissance - Moyenne puissance - Lumière rouge - Arrêt - Stroboscope
- Durée d'éclairage : haute puissance environ 2 heures, basse puissance environ 4 heures
- Portée : 200 m ; avec fonction zoom (changement du cône lumineux)
- Classe IP : IP 44 (protégée contre les projections d'eau)
- Matériau : aluminium avec poignée en plastique
- Sac : nylon 1680D ; dragonne : double dragonne de haute qualité
- Lumière blanche : LED, lumière rouge : 3 W
- pile incluse : 4 x AAA

### CARACTERÍSTICAS TÉCNICAS

- Lúmenes: 450
- Modos: Potencia alta - Potencia media - Luz roja - Apagado - Estroboscopio
- Tiempo de iluminación: 2 horas aprox. con potencia alta, 4 horas aprox. con potencia baja
- Alcance: 200 m; con función de zoom (cambio del cono de luz)
- Clase IP: IP 44 (a prueba de salpicaduras)
- Material: aluminio con mango de plástico
- Bolsa: nylon 1680D; correa: correa doble de alta calidad
- Luz blanca: LED, luz roja: 3 W
- Incluye baterías: 4 x AAA

Ref. No. Référence Referencia	EAN 4003318	Variants Exécutions Variantes	Finish Coloris Color	Box Quantity Unité d'emballage Cantidad de cajas
TL-517	63994 4	Torch 17,2 cm		1

# TL- 525

## TORCH

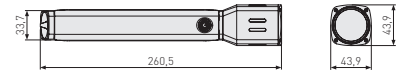

### TECHNOLOGY AND FEATURES

- Lumen: High Power 500, Low Power 250
- Modes: High Power - Medium Power - Red Light - Off - Stroboscope
- Light time: High Power approx. 3 hours, Low Power approx. 5.5 hours
- Range: 200 m; with zoom function (change light beam)
- IP Class: IP 44 (splash-proof)
- Material: Aluminium with plastic handle
- Bag: 1680D nylon; loop: high quality double loop
- White light: LED, red light: 3 W
- incl. battery: 3 x C (LR14)

### CARACTÉRISTIQUES TECHNIQUES

- Lumen : Haute puissance 500, basse puissance 250
- Modes : Haute puissance - Moyenne puissance - Lumière rouge - Arrêt - Stroboscope
- Durée d'éclairage : haute puissance environ 3 heures, basse puissance environ 5,5 heures
- Portée : 200 m ; avec fonction zoom (changement du cône lumineux)
- Classe IP : IP 44 (protégée contre les projections d'eau)
- Matériau : aluminium avec poignée en plastique
- Sac : nylon 1680D ; dragonne : double dragonne de haute qualité
- Lumière blanche : LED, lumière rouge : 3 W
- pile incluse : 3 x C (LR14)

### CARACTERÍSTICAS TÉCNICAS

- Lúmenes: potencia alta 500, potencia baja 250
- Modos: Potencia alta - Potencia media - Luz roja - Apagado - Estroboscopio
- Tiempo de iluminación: 3 horas aprox. con potencia alta, 5,5 horas aprox. con potencia baja
- Alcance: 200 m; con función de zoom (cambio del cono de luz)
- Clase IP: IP 44 (a prueba de salpicaduras)
- Material: aluminio con mango de plástico
- Bolsa: nylon 1680D; correa: correa doble de alta calidad
- Luz blanca: LED, luz roja: 3 W
- Incluye baterías: 3 x C (LR14)

Ref. No. Référence Referencia	EAN 4003318	Variants Exécutions Variantes	Finish Coloris Color	Box Quantity Unité d'emballage Cantidad de cajas
TL-525	63995 1	Torch 25,5 cm		1

# TL- 530

## TORCH

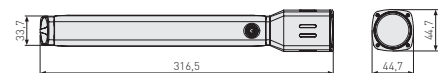

### TECHNOLOGY AND FEATURES

- Lumen: High Power 900, Low Power 500, Eco Mode 200
- Modes: High Power - Medium Power - Eco Power - Off - Stroboscope
- Light time: High Power approx. 2.5 hours, Low Power approx. 4 hours, Eco Mode 5 hours
- Range: 300 m; with zoom function (change light beam)
- IP Class: IP 44 (splash-proof)
- Material: Aluminium with plastic handle
- Bag: 1680D nylon; loop: high quality double loop
- White light: LED
- incl. batteries: 4 x C (LR14)

### CARACTÉRISTIQUES TECHNIQUES

- Lumen : haute puissance 900, basse puissance 500, mode éco 200
- Modes : Haute puissance - Moyenne puissance - Éco puissance - Arrêt - Stroboscope
- Durée d'éclairage : haute puissance environ 2,5 heures, basse puissance environ 4 heures, mode éco 5 heures
- Portée : 300 m ; avec fonction zoom (changement de cône lumineux)
- Classe IP : IP 44 (protégée contre les projections d'eau)
- Matériau : aluminium avec poignée en plastique
- Sac : nylon 1680D ; dragonne : double dragonne de haute qualité
- Lumière blanche : LED
- piles incluses : 4 x C (LR14)

### CARACTERÍSTICAS TÉCNICAS

- Lúmenes: Alta potencia 900, baja potencia 500, modo ecológico 200
- Modos: Alta potencia - Media potencia - Eco potencia - Apagado - Estroboscopio
- Tiempo de iluminación: 2,5 horas aprox. con potencia alta, 4 horas aprox. con potencia baja, 5 horas en modo Eco
- Alcance: 300 m; con función de zoom (cambio del cono de luz)
- Clase IP: IP 44 (a prueba de salpicaduras)
- Material: aluminio con mango de plástico
- Bolsa: nylon 1680D; correa: correa doble de alta calidad
- Luz blanca: LED
- Incluye baterías: 4 x C (LR14)

Ref. No. Référence Referencia	EAN 4003318	Variants Exécutions Variantes	Finish Coloris Color	Box Quantity Unité d'emballage Cantidad de cajas
TL-530	63996 8	Torch 31,6 cm		1



# SB15

## UNIVERSAL BUNGEE SET



### TECHNOLOGY AND FEATURES

- Four strong main hooks with a steel core
- Hooks can be changed easily and safely thanks to their screw-on mechanism
- Maximum load: 40 kg per bungee
- Set includes: 1x Y hook, 1x extension attachment, 1x cable grommet attachment and 2x safety hooks

### CARACTÉRISTIQUES TECHNIQUES

- Quatre crochets principaux avec cœur en acier
- Changement simple et sûr des crochets grâce aux fermetures rotatives
- Capacité de charge : 40 kg par tendeur
- Compris dans le kit : 1x crochet Y, 1x embout de prolongation, 1x embout de passage de câble et 2x crochet de sécurité

### CARACTERÍSTICAS TÉCNICAS

- Cuatro robustos ganchos principales con núcleo de acero
- Cambio fácil y seguro de ganchos mediante cierres roscados
- Capacidad de carga: 40 kg por banda elástica
- El kit incluye: 1 gancho en Y, 1 pieza prolongadora, 1 pieza pasacables y 2 ganchos de seguridad

Ref. No. Référence Referencia	EAN 4003318	Variants Exécutions Variantes	Finish Coloris Color	Box Quantity Unité d'emballage Cantidad de cajas
SB15 CL/DFNLIGBES	87115 3	Universal Bungee Set	black	1
SB15 EK DFNLIGBES	87116 0	Universal Bungee Set	black	1

# AUTOMOTIVE SECURITY BUNDLE

## CHAIN + PADLOCK COMBINATION



### TECHNOLOGY AND FEATURES

- 140 cm high-security chain
- Special hardened steel chain
- Maximum security against all kinds of attacks
- The nylon cover protects the chain surface and chrome from scratches
- 83CS/55 high-security padlock
- Body and shackle made of special hardened steel, with NANO PROTECT™ coating for extra corrosion resistance
- High-precision pin cylinder
- Comes with cylinder cover to protect the cylinder against water and dirt

### CARACTÉRISTIQUES TECHNIQUES

- Chaîne de sécurité 140 cm
- Chaîne en acier spécial cimenté
- Sécurité maximale contre tous les types d'attaques
- Gaine en nylon pour une protection contre les rayures
- Cadenas haute sécurité 83CS/55
- Corps et anse en acier spécial cimenté, avec revêtement NANO PROTECT™ pour une meilleure protection contre la corrosion
- Cylindre de précision à goupilles
- Livré avec un capuchon de protection contre l'eau et la saleté

### CARACTERÍSTICAS TÉCNICAS

- Cadena alta seguridad 140 cm
- Cadena de acero especial endurecido
- Lo máximo en seguridad contra toda clase de agresiones
- La funda de tejido evita que se produzcan daños en la pintura y en el cromo
- Candado alta seguridad 83CS/55
- Cuerpo y arco de acero especial endurecido, cromado y protegido con sistema NANO PROTECT™ contra la corrosión
- Cilindro de gran precisión de punto.
- Protector de cilindro incluido que protege al cilindro del polvo y la corrosión

Ref. No. Référence Referencia	EAN 4003318										Weight g Poids g Peso g	Level Degré Nivel	Box Quantity Unité d'emballage Cantidad de cajas
10mm Chain + 83CS/55	84664 9	55	25	28	11,5	25	94	10	14	3780		1	



# CONHASP GRANIT 215/100

CONHASP

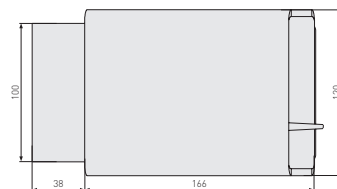
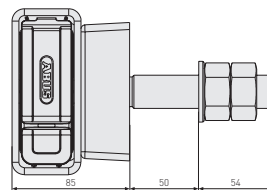

Installation Manual

DIN EN  
12320  
Kl. 5



## TECHNOLOGY AND FEATURES

- For additional security of e.g. containers
- Use suitable padlock as locking device: 37RK/70HB100, 37/55HB100 or 83/80HB100
- Extremely resistant steel
- Manufactured with special welding technology for enhanced security
- All parts corrosion resistant
- 37/55 and 37RK/70 with ABUS-Plus cylinder and code card
- Vds-certified: with 37RK/70HB100 and for 37/55HB100

## CARACTÉRISTIQUES TECHNIQUES

- Sécurisation supplémentaire d'objets
- Fermeture des deux parties par un cadenas : 37RK/70HB100, 37/55HB100 ou 83/80HB100
- Acier extrêmement dur
- Fabriqué par un procédé de soudage spécial pour une sécurité améliorée
- Toutes les pièces sont traitées anti-corrosion
- 37/55 et 37RK/70 avec cylindre ABUS-Plus et une Code card ABUS
- Homologation Vds : avec 37RK/70HB100 et pour 37/55HB100

## CARACTERÍSTICAS TÉCNICAS

- Copia de seguridad adicional de los objetos
- Puede ir equipado con los modelos de candados siguientes: 37RK/70HB100, 37/55HB100 ó 83/80HB100
- Acero extremadamente resistente
- Tecnología especial de soldadura para una resistencia aún mayor
- Todos los componentes son resistentes a la corrosión
- 37/55 y 37RK / 70 con cilindro ABUS-Plus y tarjeta de códigos
- Reconocido por Vds: 37RK/70HB100 y para 37/55HB100

Ref. No. Référence Referencia	EAN 4003318	Length mm Longueur mm Larga mm	Width mm Largeur mm Ancho mm	Depth mm Profondeur mm Profundidad mm	Variants Exécutions Variantes	Level Degré Nivel	Box Quantity Unité d'emballage Cantidad de cajas
ConHasp Granit 215/100 + 37/55HB100 vs.	45707 4	220	120	85		10	1
ConHasp Granit 215/100 + 37RK/70HB100 vs.	45708 1	220	120	85		10	1
ConHasp Granit 215/100 + 83/80HB100 (without cylinder)	52500 1	220	120	85	Padlock without cylinder	10	1

## CONHASP

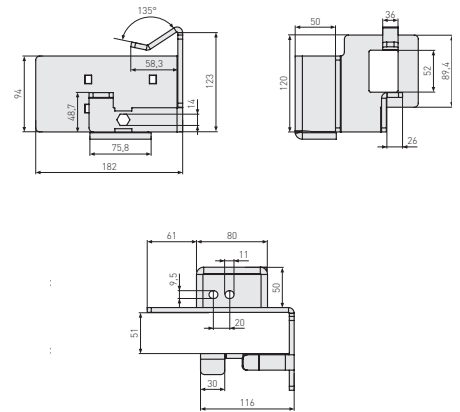

### TECHNOLOGY AND FEATURES

- Additional security device for containers
- Locking of multi-part construction via internal padlock with exchangeable 10/30 euro profile half cylinder
- Extremely resistant steel
- All parts corrosion protected
- Assembly in 60 seconds
- One hand operation
- SP approval: Certified according to SSF 1051 class 5 (Approval with ABUS Vitess 4000 V4L452 10/30 profile half cylinder only)

### CARACTÉRISTIQUES TECHNIQUES

- Sécurité supplémentaire pour les conteneurs
- La structure en plusieurs parties est verrouillée par un cadenas interne avec un demi-cylindre europrofil 10/30 remplaçable
- Acier extrêmement résistant
- Toutes les pièces sont traitées anti-corrosion
- Assemblage en 60 secondes
- Utilisation d'une seule main
- Homologation CS : Certifié selon SSF 1051 classe 5 (homologation uniquement en lien avec ABUS Vitess 4000 V4L452 demi-cylindre profil 10/30)

### CARACTERÍSTICAS TÉCNICAS

- Protección adicional para contenedores
- Cierre de la construcción en varias partes mediante candado interno con medio cilindro de perfil europeo 10/30 intercambiable
- Acero extremadamente resistente
- Todas las piezas protegidas contra la corrosión
- Montaje en 60 segundos
- Manejo con una mano
- Homologación con ensayos de seguridad: Certificado según SSF 1051, clase 5 (homologación válida únicamente en combinación con medio cilindro de perfil 10/30 ABUS Vitess 4000 V4L452)

Ref. No. Référence Referencia	EAN 4003318	Length mm Longueur mm Larga mm	Width mm Largeur mm Ancho mm	Depth mm Profondeur mm Profundidad mm	Variants Exécutions Variantes	Level Degré Nivel	Box Quantity Unité d'emballage Cantidad de cajas
ConHasp 230/100 with cylinder Vitess 4000	83452 3	182	94	123		10	1
ConHasp 230/100 without cylinder	87566 3	182	94	123	without cylinder	10	1



## SOCKET PROTECTOR



### TECHNOLOGY AND FEATURES

- JC2208: Scope of delivery: 8 x + 1 (special key)
- JC2216: Content: 16 x socket protector, 2 keys
- Childproof: can only be removed with the special key
- Discreet, unobtrusive design

### CARACTÉRISTIQUES TECHNIQUES

- JC2208: Contenu de la livraison : 8 x + 1 (clés spéciales)
- JC2216: Contenu : 16 x protecteurs de prise, 2 clés
- Sécurité enfant : peut uniquement être retiré à l'aide d'une clé spéciale
- Design discret, effacé

### CARACTERÍSTICAS TÉCNICAS

- JC2208: Alcance de suministro: 8 unidades + 1 (llave especial)
- JC2216: Contenido 16 protecciones de enchufe, 2 llaves
- A prueba de niños: solo se puede extraer con una llave especial
- Diseño discreto y sutil
- Sin PVC

Ref. No. Référence Referencia	EAN 4003318	Variants Exécutions Variantes	Finish Coloris Color	Box Quantity Unité d'emballage Cantidad de cajas
JC2208 Emma	73133 4	Socket protector 8 x + 1 (special key)	white	1
JC2216 Emma	90111 9	Socket protector 16 x + 2 (special key)	white	1

# JC2100A GRETA

## SOCKET PROTECTOR



### TECHNOLOGY AND FEATURES

- Simple installation – no drilling, gluing or screws required
- Childproof: can only be removed using a special key
- Discreet, unobtrusive design

### CARACTÉRISTIQUES TECHNIQUES

- Montage facile, sans perçage, vissage ou collage
- Sécurité enfant : peut uniquement être retiré à l'aide d'une clé spéciale
- Design discret, effacé

### CARACTERÍSTICAS TÉCNICAS

- Protege los enchufes de las manos curiosas de los niños
- Montaje sencillo y rápido sin atornillar ni pegar
- Solo se puede quitar con un conector (= a prueba de niños)
- Diseño discreto y sutil
- Sin PVC
- Alcance de suministro: 6 unidades

Ref. No. Référence Referencia	EAN 4003318	Variants Exécutions Variantes	Finish Coloris Color	Box Quantity Unité d'emballage Cantidad de cajas
JC2100A GRETA	76975 7	Socket protector	white	1

# JC4700 KAY

## STOVE GUARD



### TECHNOLOGY AND FEATURES

- Diagonal construction makes it difficult to spill over onto the cooker (angle 45 degrees)
- Flat, ergonomic design
- Variable width from 50,5 to 91 centimetres
- Simple installation (sticks) no drilling or screws required
- Transparent, inconspicuous material

### CARACTÉRISTIQUES TECHNIQUES

- La structure en biais empêche les enfants de poser leurs mains sur le foyer (angle de 45 degrés)
- Design plat, ergonomique
- Largeur variable de 50,5 à 91 centimètres
- Montage facile (collage) sans perçage ni vissage
- Matériau transparent et discret

### CARACTERÍSTICAS TÉCNICAS

- El diseño inclinado dificulta el acceso a los fogones (ángulo de 45 grados)
- Diseño plano y ergonómico
- Anchura variable de 50,5 a 91 centímetros
- Montaje sencillo (adhesivo) sin necesidad de taladrar ni atornillar
- Material transparente y discreto
- Sin PVC

Ref. No. Référence Referencia	EAN 4003318	Variants Exécutions Variantes	Finish Coloris Color	Box Quantity Unité d'emballage Cantidad de cajas
JC4700 KAY	73128 0	Stove guard	transparent	1

# JC4600 NINA

## OVEN DOOR GUARD



### TECHNOLOGY AND FEATURES

- Simple installation with adhesive pad
- Fits all current oven doors
- Heat-resistant plastic
- Also suitable for washing machine and dishwasher doors (depending on model)

### CARACTÉRISTIQUES TECHNIQUES

- Montage facile avec patin adhésif
- S'ajuste sur toutes les portes de four courantes
- Plastique thermorésistant
- Également adaptée aux portes de machines à laver et de lave-vaisselle (selon les modèles)

### CARACTERÍSTICAS TÉCNICAS

- Fácil montaje con almohadilla adhesiva
- Plástico resistente al calor
- Apto para todas las puertas actuales de horno, de lavadora y lavavajillas.
- Sin PVC

Ref. No. Référence Referencia	EAN 4003318	Variants Exécutions Variantes	Finish Coloris Color	Box Quantity Unité d'emballage Cantidad de cajas
JC4600 NINA	73132 7	Oven door guard	vanilla	1

# JC1430 NOAH

## FLOWER POT GUARD

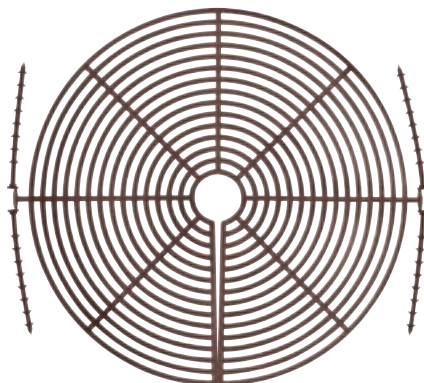

### TECHNOLOGY AND FEATURES

- Diameter: up to 30 centimetres, can be cut to size
- Scope of delivery: 2 x including fixing rods
- Also suitable for protecting pets

### CARACTÉRISTIQUES TECHNIQUES

- Diamètre : jusqu'à 30 centimètres, découpage
- Contenu de la livraison : 2 x tiges de fixation incluses
- Convient également pour les animaux domestiques

### CARACTERÍSTICAS TÉCNICAS

- Diámetro: hasta 30 centímetros, se puede cortar a medida
- Alcance de suministro: 2 unidades, incluidas las varillas de fijación
- También apta para mascotas
- Sin PVC

Ref. No. Référence Referencia	EAN 4003318	Variants Exécutions Variantes	Finish Coloris Color	Box Quantity Unité d'emballage Cantidad de cajas
JC1430 NOAH	73158 7	Flower pot guard	brown	1

# JC1100A DANNI

## UNIVERSAL BOLT



### TECHNOLOGY AND FEATURES

- The bolt can be opened from both sides using a push button
- Simple installation thanks to 3M adhesive tabs (included)

### CARACTÉRISTIQUES TECHNIQUES

- Le pêne peut s'ouvrir des deux côtés grâce à un bouton-poussoir
- Montage simple grâce à des étiquettes autocollantes 3M (compris dans la livraison)

### CARACTERÍSTICAS TÉCNICAS

- El dispositivo de cierre puede abrirse por ambos lados con un botón
- Colocación sencilla mediante almohadilla adhesiva 3M
- Sin PVC

Ref. No. Référence Referencia	EAN 4003318	Variants Exécutions Variantes	Finish Coloris Color	Box Quantity Unité d'emballage Cantidad de cajas
JC1100A DANNI	76971 9	Universal bolt	white	1

# JC4800 ISA

## TV TILT PROTECTION



### TECHNOLOGY AND FEATURES

- Simple installation
- Can be fixed to the wall or a piece of furniture
- Strap length: variable/adjustable
- Included in the scope of delivery: Installation materials

### CARACTÉRISTIQUES TECHNIQUES

- Montage simple
- Fixée au mur ou à un meuble
- Longueur de la sangle : variable/réglable
- Compris dans la livraison : matériel d'installation

### CARACTERÍSTICAS TÉCNICAS

- Montaje sencillo
- Se fija a la pared o a un mueble
- Longitud de la correa: variable/ajustable de 10 a 66 cm
- Incluido en la alcance de suministro: material de fijación
- Sin PVC
- Alcance de suministro: 2 unidades

Ref. No. Référence Referencia	EAN 4003318	Variants Exécutions Variantes	Finish Coloris Color	Box Quantity Unité d'emballage Cantidad de cajas
JC4800 ISA	73129 7	TV tilt protection	black	1

# JC4300A MARA

## CABINET DOOR LOCK



### TECHNOLOGY AND FEATURES

- Simple installation – no drilling, gluing or screws required

### CARACTÉRISTIQUES TECHNIQUES

- Montage facile, sans perçage, vissage ou collage

### CARACTERÍSTICAS TÉCNICAS

- Fácil instalación: sin taladrar, atornillar ni pegar
- Apto tanto para tiradores de asa o de pomo
- Sin PVC

Ref. No. Référence Referencia	EAN 4003318	Variants Exécutions Variantes	Finish Coloris Color	Box Quantity Unité d'emballage Cantidad de cajas
JC4300A MARA	76972 6	Cabinet door lock	white	1

# JC4200A LIA

## GLASS DOOR LATCH



### TECHNOLOGY AND FEATURES

- Easy release by pressing the lock
- Simple installation thanks to 3M adhesive tabs (included)

### CARACTÉRISTIQUES TECHNIQUES

- Déverrouillage simple en appuyant sur le dispositif de blocage
- Montage simple grâce à des étiquettes autocollantes 3M (compris dans la livraison)

### CARACTERÍSTICAS TÉCNICAS

- Desbloqueo fácil presionando el cierre
- Colocación sencilla mediante almohadilla adhesiva 3M
- Espacio máximo entre las hojas de la puerta 30 mm
- Sin PVC

Ref. No. Référence Referencia	EAN 4003318	Variants Exécutions Variantes	Finish Coloris Color	Box Quantity Unité d'emballage Cantidad de cajas
JC4200A LIA	76970 2	Glass door latch	white	1

# JC4900 JULIAN

## CABINET LOCK WITH FLEXIBLE STRAP



### TECHNOLOGY AND FEATURES

- Simple installation – no drilling, gluing or screws required
- Length individually adjustable

### CARACTÉRISTIQUES TECHNIQUES

- Montage facile, sans perçage, vissage ou collage
- Longueur réglable individuellement

### CARACTERÍSTICAS TÉCNICAS

- Montaje sencillo: sin taladrar, atornillar ni pegar.
- Longitud ajustable
- Sin PVC

Ref. No. Référence Referencia	EAN 4003318	Variants Exécutions Variantes	Finish Coloris Color	Box Quantity Unité d'emballage Cantidad de cajas
JC4900 JULIAN	74228 6	Cabinet lock	white	1



# JC4400 LENNY

## DRAWER LOCK



### TECHNOLOGY AND FEATURES

- Installation: Screw in from the inside
- Discreet, inconspicuous design
- Included in the scope of delivery: Screws

### CARACTÉRISTIQUES TECHNIQUES

- Montage : Vissage de l'intérieur
- Design discret, effacé
- Compris dans la livraison : vis

### CARACTERÍSTICAS TÉCNICAS

- Montaje: atornillado desde el interior
- Diseño discreto y sutil
- Incluido en la alcance de suministro: tornillos
- Sin PVC
- Alcance de suministro: 3 unidades

Ref. No. Référence Referencia	EAN 4003318	Variants Exécutions Variantes	Finish Coloris Color	Box Quantity Unité d'emballage Cantidad de cajas
JC4400 LENNY	73161 7	Drawer lock	white	1

# JC4100A SINA

## DRAWER LOCK



### TECHNOLOGY AND FEATURES

- The locking mechanism can be opened by pressing the little hooks together
- Discreet, inconspicuous design
- Installation: screw in from the inside. Included in the scope of delivery: screws

### CARACTÉRISTIQUES TECHNIQUES

- Le mécanisme de la sécurité s'ouvre sur pression du crochet
- Design discret, effacé
- Montage : Vissage de l'intérieur. Compris dans la livraison : vis

### CARACTERÍSTICAS TÉCNICAS

- Apertura sencilla apretando el cierre de seguridad
- Gracias al montaje en el interior, el cierre de seguridad no es visible desde fuera
- Montaje: Atornillando en el interior. Incluido en la alcance de suministro: tornillos
- Sin PVC
- Alcance de suministro: 4 unidades

Ref. No. Référence Referencia	EAN 4003318	Variants Exécutions Variantes	Finish Coloris Color	Box Quantity Unité d'emballage Cantidad de cajas
JC4100A SINA	76973 3	Drawer lock	white	1

# JC6602 MIMI

## LOCK STRIPE



### TECHNOLOGY AND FEATURES

- Velcro fastener

### CARACTÉRISTIQUES TECHNIQUES

- Fermeture velcro

### CARACTERÍSTICAS TÉCNICAS

- Cierre de velcro
- Longitud aproximada de 160 mm
- Sin PVC
- Alcance de suministro: 2 unidades

Ref. No. Référence Referencia	EAN 4003318	Variants Exécutions Variantes	Finish Coloris Color	Box Quantity Unité d'emballage Cantidad de cajas
JC6602 MIMI	74227 9	Lock stripe	white	1

# JC4500 MARC

## MAGNETIC CLOSURE

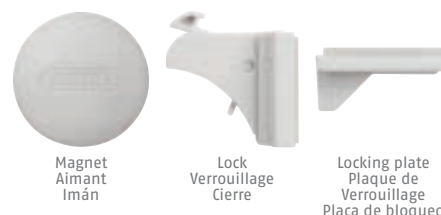

Magnet  
Aimant  
Imán

Lock  
Verrouillage  
Cierre

Locking plate  
Plaque de  
Verrouillage  
Placa de bloqueo

### TECHNOLOGY AND FEATURES

- Childproof: can only be opened with the special magnetic key
- Simple installation: stick or screw – no drilling required!
- Up to a wood thickness of 25 millimetres

### CARACTÉRISTIQUES TECHNIQUES

- Sécurité enfant : ouvrable uniquement avec une clé magnétique spéciale
- Montage facile : par collage ou vissage – sans perçage !
- Jusqu'à une épaisseur de bois de 25 millimètres

### CARACTERÍSTICAS TÉCNICAS

- A prueba de niños: solo se puede abrir con una llave magnética especial
- Montaje sencillo: se pega o se enrosca, ¡sin necesidad de taladrar!
- Para materiales de hasta 25 milímetros de grosor (madera)
- Alcance de suministro: 3 cierres magnéticos, 1 llave magnética
- Sin PVC

Ref. No. Référence Referencia	EAN 4003318	Variants Exécutions Variantes	Finish Coloris Color	Box Quantity Unité d'emballage Cantidad de cajas
JC4500 MARC	73144 0	Magnetic closure	white	1

# JC1200A JONAS

## UNIVERSAL BOLT



### TECHNOLOGY AND FEATURES

- The bolt can be opened from both sides
- Simple installation thanks to 3M adhesive tabs (included)

### CARACTÉRISTIQUES TECHNIQUES

- Le pêne peut s'ouvrir des deux côtés
- Montage simple grâce à des étiquettes autocollantes 3M (compris dans la livraison)

### CARACTERÍSTICAS TÉCNICAS

- El dispositivo de cierre puede abrirse por ambos lados con un botón
- Colocación sencilla mediante almohadilla adhesiva 3M
- Sin PVC
- Alcance de suministro: 2 unidades

Ref. No. Référence Referencia	EAN 4003318	Variants Exécutions Variantes	Finish Coloris Color	Box Quantity Unité d'emballage Cantidad de cajas
JC1200A JONAS	76965 8	Universal bolt	transparent	1

# JC8320 JAN

## NEW

## TICK PROTECTION



### TECHNOLOGY AND FEATURES

- Emits a series of ultrasonic pulses that are not perceptible to humans, dogs or wildlife, but affect the orientation ability of ticks
- Integrated battery
- Size: approx. 4 x 3 x 1.5 cm compact

### CARACTÉRISTIQUES TECHNIQUES

- Emet une série d'impulsions ultrasoniques qui ne sont pas perceptibles par les humains, les chiens ou les animaux sauvages, mais qui affectent la capacité d'orientation des tiques
- Batterie intégrée
- Taille : environ 4 x 3 x 1,5 cm compact

### CARACTERÍSTICAS TÉCNICAS

- Emite una serie de pulsos ultrasónicos que no son perceptibles para los seres humanos, los perros ni los animales salvajes, pero que afectan a la capacidad de orientación de las garrapatas
- Batería integrada
- Tamaño: aprox. 4 x 3 x 1,5 cm, compacto

Ref. No. Référence Referencia	EAN 4003318	Variants Exécutions Variantes	Finish Coloris Color	Box Quantity Unité d'emballage Cantidad de cajas
JC8320 Jan	90129 4	Tick protection	orange	1

## LED LIGHT



### TECHNOLOGY AND FEATURES

- Continuous and flashing light function at the touch of a button
- Visibility: 150 m
- High-quality high-gloss material, yellow with 4 red LEDs
- Fully shrink-wrapped, waterproof exterior
- Incl. battery CR2032

### CARACTÉRISTIQUES TECHNIQUES

- Fonction lumière permanente et clignotante par simple pression d'un bouton
- Visibilité : 150 m
- Matériau brillant de haute qualité, jaune avec 4 LED rouges
- Extérieur soudé et imperméable
- Pile CR2032 incluse

### CARACTERÍSTICAS TÉCNICAS

- Función de luz fija e intermitente con solo pulsar un botón
- Visibilidad: 150 m
- Material muy brillante de alta calidad, amarillo con 4 LED rojos
- Exterior totalmente retractilado e impermeable
- Incluye pila CR2032

Ref. No. Référence Referencia	EAN 4003318	Variants Exécutions Variantes	Finish Coloris Color	Box Quantity Unité d'emballage Cantidad de cajas
JC6520 Nils	90136 2	LED Light	neon yellow	1

# JC6540 LINUS

# NEW

## LED LIGHT



### TECHNOLOGY AND FEATURES

- Permanent light and flashing light function at the touch of a button
- Tested according to European standard EN 13356:2001
- Visibility: 150 m
- High-quality high-gloss material, yellow with 4 red LEDs
- Fully shrink-wrapped, waterproof exterior
- Incl. battery CR2032

### CARACTÉRISTIQUES TECHNIQUES

- Fonction lumière permanente et lumière clignotante par simple pression sur un bouton
- Testé selon la norme européenne EN 13356:2001
- Visibilité : 150 m
- Matériau brillant de haute qualité, jaune avec 4 LED rouges
- Extérieur soudé et imperméable
- Pile CR2032 incluse

### CARACTERÍSTICAS TÉCNICAS

- Función de luz fija y luz intermitente con solo pulsar un botón
- Probado según la norma europea EN 13356:2001
- Visibilidad: 150 m
- Material muy brillante de alta calidad, amarillo con 4 LED rojos
- Exterior totalmente retractilado e impermeable
- Incluye pila CR2032

Ref. No. Référence Referencia	EAN 4003318	Variants Exécutions Variantes	Finish Coloris Color	Box Quantity Unité d'emballage Cantidad de cajas
JC6540 Linus	90134 8	LED Light	neon yellow	1

## LED ARMBAND

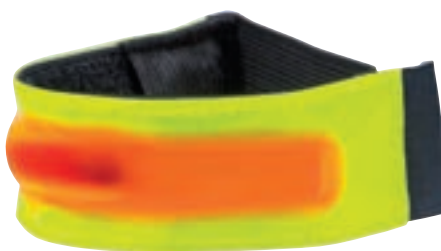

### TECHNOLOGY AND FEATURES

- Continuous and flashing light function at the touch of a button
- Tested according to European standard EN 13356:2001
- Visibility: 150 m
- High-quality high-gloss material, yellow with a large LED band
- Fully shrink-wrapped, waterproof exterior
- Incl. battery CR2032

### CARACTÉRISTIQUES TECHNIQUES

- Fonction lumière permanente et clignotante par simple pression d'un bouton
- Testé selon la norme européenne EN 13356:2001
- Visibilité : 150 m
- Matériau brillant de haute qualité, jaune avec une grande bande LED
- Extérieur soudé et imperméable
- Pile CR2032 incluse

### CARACTERÍSTICAS TÉCNICAS

- Función de luz fija e intermitente con solo pulsar un botón
- Probado según la norma europea EN 13356:2001
- Visibilidad: 150 m
- Material muy brillante de alta calidad, amarillo con una gran banda LED
- Exterior totalmente retráctilado e impermeable
- Incluye pila CR2032

Ref. No. Référence Referencia	EAN 4003318	Variants Exécutions Variantes	Finish Coloris Color	Box Quantity Unité d'emballage Cantidad de cajas
JC6560 TILL	90137 9	LED armband	neon yellow	1

## REFLECTOR STRIP



### TECHNOLOGY AND FEATURES

- UV-resistant material (meets the requirements of the European standard EN2471), shines even after years of use.
- Two highly reflective stripes for very good visibility at night, but also very good visibility during the day.
- Visibility: 150 m
- Flexible thanks to the Velcro fastener (from approx. 82 to 108 cm circumference)

### CARACTÉRISTIQUES TECHNIQUES

- Matériau résistant aux UV (conforme aux exigences de la norme européenne EN2471), brille même après des années d'utilisation.
- Deux bandes hautement réfléchissantes pour une très bonne visibilité de nuit comme de jour.
- Visibilité : 150 m
- Flexible grâce à la fermeture Velcro (de 82 à 108 cm de circonférence environ)

### CARACTERÍSTICAS TÉCNICAS

- Material resistente a los rayos UV (cumple los requisitos de la norma europea EN2471), brilla incluso tras años de uso.
- Dos bandas altamente reflectantes para una excelente visibilidad durante la noche, pero también durante el día.
- Visibilidad: 150 m
- Flexible gracias al cierre de velcro (de 82 a 108 cm de circunferencia aproximadamente)

Ref. No. Référence Referencia	EAN 4003318	Variants Exécutions Variantes	Finish Coloris Color	Box Quantity Unité d'emballage Cantidad de cajas
JC6715 Theo	90135 5	Reflector strip	neon yellow	1

## SAFETY VEST



### TECHNOLOGY AND FEATURES

- UV-resistant material (meets the requirements of the European standard EN2471), shines even after years of use.
- Four highly reflective stripes for very good visibility at night, but also very good visibility during the day.
- Visibility: 150 m
- Tested according to European Standard EN 17353:2020 (AB3)
- Branded zip ensures a good fit on the body

### CARACTÉRISTIQUES TECHNIQUES

- Matériau résistant aux UV (conforme aux exigences de la norme européenne EN2471), brille même après des années d'utilisation.
- Quatre bandes hautement réfléchissantes pour une très bonne visibilité de nuit, mais aussi une très bonne visibilité de jour.
- Visibilité : 150 m
- Testé selon la norme européenne EN 17353:2020 (AB3)
- La fermeture éclair de marque assure une bonne tenue sur le corps

### CARACTERÍSTICAS TÉCNICAS

- Material resistente a los rayos UV (cumple los requisitos de la norma europea EN2471), brilla incluso tras años de uso.
- Cuatro bandas altamente reflectantes para una excelente visibilidad durante la noche, pero también durante el día.
- Visibilidad: 150 m
- Probado según la norma europea EN 17353:2020 (AB3)
- La cremallera de marca garantiza un buen ajuste al cuerpo

Ref. No. Référence Referencia	EAN 4003318	Variants Exécutions Variantes	Finish Coloris Color	Box Quantity Unité d'emballage Cantidad de cajas
JC6800 Leon (S)	90133 1	Safety vest	neon yellow	1
JC6800 Leon (M)	90132 4	Safety vest	neon yellow	1

# JC6900 MAX

# NEW

## „FULL REFLECTIVE“ SAFETY VEST



### TECHNOLOGY AND FEATURES

- Fully reflective safety vest: Almost the entire surface of the safety vest is brightly illuminated by headlights
- Visibility: 150 m
- Tested according to European Standard EN 17353:2020 (B3)
- Branded zip ensures a good fit on the body

### CARACTÉRISTIQUES TECHNIQUES

- Gilet haute visibilité entièrement réfléchissant : La quasi-totalité de la surface du gilet de haute visibilité est éclairée par les phares
- Visibilité : 150 m
- Testé selon la norme européenne EN 17353:2020 (B3)
- La fermeture éclair de marque assure une bonne tenue sur le corps

### CARACTERÍSTICAS TÉCNICAS

- Chaleco totalmente reflectante: casi toda la superficie del chaleco se ilumina a la luz de los faros
- Visibilidad: 150 m
- Probado según la norma europea EN 17353:2020 (B3)
- La cremallera de marca garantiza un buen ajuste al cuerpo

Ref. No. Référence Referencia	EAN 4003318	Variants Exécutions Variantes	Finish Coloris Color	Box Quantity Unité d'emballage Cantidad de cajas
JC6900 Max (S)	90130 0	„Full Reflective“ safety vest	grey	1
JC6900 Max (M)	90131 7	„Full Reflective“ safety vest	grey	1



# JC5100A NESSA

## DOOR LOCK



### TECHNOLOGY AND FEATURES

- The flexible plastic material reliably dampens the closing of doors or windows without damaging them
- Easy and residue-free installation: the lock is hung on the hinge of the door or window
- Alternatively the hinge lock can be placed in any position on the door or window frame using the counter component (included in the scope of delivery)

### CARACTÉRISTIQUES TECHNIQUES

- Le plastique flexible maintient les portes ou fenêtres ouvertes de manière fiable sans les endommager
- Montage simple et sans résidus : la protection est accrochée à la charnière de la porte ou de la fenêtre
- En option, la protection pour charnière peut être installée à l'aide d'une contre-pièce (comprise dans la livraison) dans une position souhaitée au cadre de porte ou fenêtre

### CARACTERÍSTICAS TÉCNICAS

- Le plastique flexible maintient les portes ou fenêtres ouvertes de manière fiable sans les endommager
- Montage simple et sans résidus : la protection est accrochée à la charnière de la porte ou de la fenêtre
- En option, la protection pour charnière peut être installée à l'aide d'une contre-pièce (comprise dans la livraison) dans une position souhaitée au cadre de porte ou fenêtre

Ref. No. Référence Referencia	EAN 4003318	Variants Exécutions Variantes	Finish Coloris Color	Box Quantity Unité d'emballage Cantidad de cajas
JC5100A NESSA	76974 0	Door lock	white	1

# JC6100A LEIF

## DOORSTOP



### TECHNOLOGY AND FEATURES

- Also secure on flat surfaces

### CARACTÉRISTIQUES TECHNIQUES

- Sûr même sur des surfaces lisses

### CARACTERÍSTICAS TÉCNICAS

- Antideslizante incluso sobre superficies lisas
- Se adapta a cualquier distancia entre la puerta y el suelo de forma flexible
- chapa fina de acero inoxidable de 0,4 mm con extremos de goma. Permite su colocación en el estrecho espacio entre la puerta y el suelo
- Fuerza de retorno muy elevada de la chapa de acero inoxidable
- Sin PVC

Ref. No. Référence Referencia	EAN 4003318	Variants Exécutions Variantes	Finish Coloris Color	Box Quantity Unité d'emballage Cantidad de cajas
JC6100A LEIF	76968 9	Doorstop	grey	1



# JC6200 LUCA

## DOORSTOP



### TECHNOLOGY AND FEATURES

- Also secure on flat surfaces
- Transparent design
- Simply hangs from the door handle
- The soft material stops the door panel from being damaged

### CARACTÉRISTIQUES TECHNIQUES

- Sûr même sur des surfaces lisses
- Design transparent
- Peut être accroché simplement à la poignée de porte
- Le vantail de la porte n'est pas détérioré par le matériau souple

### CARACTERÍSTICAS TÉCNICAS

- No resbala sobre la mayoría de los pavimentos
- Diseño transparente y discreto
- Se puede colgar en el pomo de la puerta
- El material suave no daña la puerta.
- Sin PVC

Ref. No. Référence Referencia	EAN 4003318	Variants Exécutions Variantes	Finish Coloris Color	Box Quantity Unité d'emballage Cantidad de cajas
JC6200 LUCA	73137 2	Doorstop	transparent	1

# JC5200A MILLIE

## DOORSTOP



### TECHNOLOGY AND FEATURES

- The soft material stops the door panel from being damaged
- Simply hangs from the door handle

### CARACTÉRISTIQUES TECHNIQUES

- Le vantail de la porte n'est pas détérioré par le matériau souple
- Peut être accroché simplement à la poignée de porte

### CARACTERÍSTICAS TÉCNICAS

- La espuma flexible y resistente amortigua de forma fiable las puertas o ventanas sin dañarlas
- Especialmente práctico: el amortiguador para puerta se puede acoplar a la manilla de la puerta
- Sin PVC

Ref. No. Référence Referencia	EAN 4003318	Variants Exécutions Variantes	Finish Coloris Color	Box Quantity Unité d'emballage Cantidad de cajas
JC5200 MILLIE	76969 6	Doorstop	grey	1

# JC7100 NINO

## WINDOW CATCH



### TECHNOLOGY AND FEATURES

- Included in the scope of delivery: Fitting with 3M sticky label and (optional) screws

### CARACTÉRISTIQUES TECHNIQUES

- Compris dans la livraison : fixation à l'aide d'une étiquette autocollante 3M et de vis (facultatif)

### CARACTERÍSTICAS TÉCNICAS

- Incluido en la alcance de suministro: fijación con etiqueta adhesiva 3M y tornillos (opcionales)
- Distancia máxima de apertura de la ventana 120 mm (debido al diseño)
- Sin PVC

Ref. No. Référence Referencia	EAN 4003318	Variants Exécutions Variantes	Finish Coloris Color	Box Quantity Unité d'emballage Cantidad de cajas
JC7100 NINO	73136 5	Window catch	white	1

# JC5401 MINA

**NEW**

## DOOR STOP/DAMPER

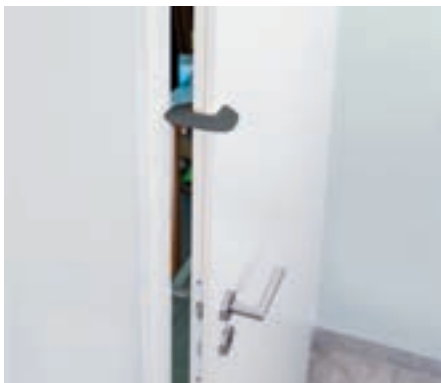

### TECHNOLOGY AND FEATURES

- Product tested according to EN 16654:2015
- For door panel thicknesses from 30 to 50 mm
- PVC-free

### CARACTÉRISTIQUES TECHNIQUES

- Produit testé selon la norme EN 16654:2015
- Pour des épaisseurs de battant de porte de 30 à 50 mm
- Sans PVC

### CARACTERÍSTICAS TÉCNICAS

- Producto probado según la norma EN 16654:2015
- Para hojas de puerta de entre 30 y 50 mm de grosor
- Sin PVC

Ref. No. Référence Referencia	EAN 4003318	Variants Exécutions Variantes	Finish Coloris Color	Box Quantity Unité d'emballage Cantidad de cajas
JC5401 Mina	90097 6	Door stop/damper	anthracite	1
JC5401 Mina	90098 3	Door stop/damper Set of 2	anthracite	1
JC5401 Mina	90099 0	Door stop/damper Set of 3	anthracite	1

# JC8670 LUCY

**NEW**

## LED NIGHT LIGHT

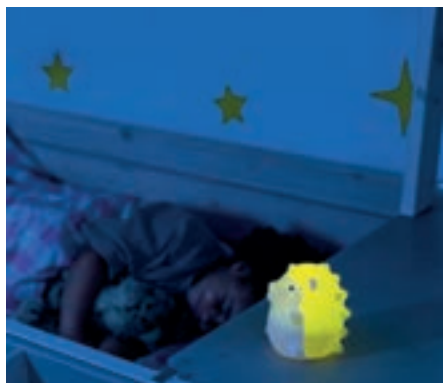

### TECHNOLOGY AND FEATURES

- Two brightness modes selectable at the touch of a button
- Automatic switch-off after approx. 30 minutes
- Height approx. 12 cm
- Screw-in battery compartment for 3 AAA batteries (use of rechargeable batteries possible). Batteries not included.
- Meets the strict requirements of the European standard EN71

### CARACTÉRISTIQUES TECHNIQUES

- Deux modes de luminosité sélectionnables par simple pression sur un bouton
- Arrêt automatique après environ 30 minutes
- Hauteur environ 12 cm
- Logement de piles vissé pour 3 piles AAA (utilisation de piles rechargeables possible). Piles non incluses.
- Répond aux exigences strictes de la norme européenne EN71

### CARACTERÍSTICAS TÉCNICAS

- Dos modos de luminosidad seleccionables con solo pulsar un botón
- Desconexión automática tras unos 30 minutos
- Altura aprox. 12 cm
- Compartimento de pilas atornillado para 3 pilas AAA (es posible utilizar pilas recargables). Pilas no incluidas.
- Cumple los estrictos requisitos de la norma europea EN71

Ref. No. Référence Referencia	EAN 4003318	Variants Exécutions Variantes	Finish Coloris Color	Box Quantity Unité d'emballage Cantidad de cajas
JC8670 Lucy	90125 6	LED night light	yellow-white	1

Junior Care

# JC8690 MILA

**NEW**

## LED NIGHT LIGHT

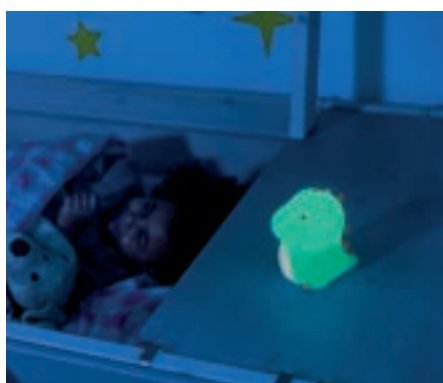

### TECHNOLOGY AND FEATURES

- Two brightness modes selectable at the touch of a button
- Automatic switch-off after approx. 30 minutes
- Height approx. 12 cm
- Screw-down battery compartment for three AAA batteries (use of rechargeable batteries possible). Batteries not included.
- Meets the strict requirements of the European standard EN71

### CARACTÉRISTIQUES TECHNIQUES

- Deux modes de luminosité sélectionnables par simple pression sur un bouton
- Arrêt automatique après environ 30 minutes
- Hauteur environ 12 cm
- Logement de piles vissé pour trois piles AAA (utilisation de piles rechargeables possible). Piles non incluses.
- Répond aux exigences strictes de la norme européenne EN71

### CARACTERÍSTICAS TÉCNICAS

- Dos modos de luminosidad seleccionables con solo pulsar un botón
- Desconexión automática tras unos 30 minutos
- Altura aprox. 12 cm
- Compartimento de pilas atornillado para tres pilas AAA (es posible utilizar pilas recargables). Pilas no incluidas.
- Cumple los estrictos requisitos de la norma europea EN71

Ref. No. Référence Referencia	EAN 4003318	Variants Exécutions Variantes	Finish Coloris Color	Box Quantity Unité d'emballage Cantidad de cajas
JC8690 Mila	90123 2	LED night light	green-white	1

## LED NIGHT LIGHT



### TECHNOLOGY AND FEATURES

- Two brightness modes selectable at the touch of a button
- Automatic switch-off after approx. 30 minutes
- Height approx. 12 cm
- Screw-in battery compartment for 3 AAA batteries (use of rechargeable batteries possible). Batteries not included.
- Meets the strict requirements of the European standard EN71

### CARACTÉRISTIQUES TECHNIQUES

- Deux modes de luminosité sélectionnables par simple pression sur un bouton
- Arrêt automatique après environ 30 minutes
- Hauteur environ 12 cm
- Logement de piles vissé pour 3 piles AAA (utilisation de piles rechargeables possible). Piles non incluses.
- Répond aux exigences strictes de la norme européenne EN71

### CARACTERÍSTICAS TÉCNICAS

- Dos modos de luminosidad seleccionables con solo pulsar un botón
- Desconexión automática tras unos 30 minutos
- Altura aprox. 12 cm
- Compartimento de pilas atornillado para 3 pilas AAA (es posible utilizar pilas recargables). Pilas no incluidas.
- Cumple los estrictos requisitos de la norma europea EN71

Ref. No. Référence Referencia	EAN 4003318	Variants Exécutions Variantes	Finish Coloris Color	Box Quantity Unité d'emballage Cantidad de cajas
JC8680 Dana	90124 9	LED night light	green	1

# JC8650 LILY

## NIGHT LIGHT WITH TEMPERATURE DISPLAY



### TECHNOLOGY AND FEATURES

- Blue = less than 14 degrees Celsius
- Green = 15 to 20 degrees Celsius
- Orange = 21 to 26 degrees Celsius
- Red = more than 27 degrees Celsius
- Included in the scope of delivery: Micro USB charging cable
- Lithium-ion battery
- Maximum lighting time: approx. 45 hours (with fully charged battery)

### CARACTÉRISTIQUES TECHNIQUES

- Bleu = moins de 14 °C
- Vert = de 15 à 20 °C
- Orange = de 21 à 26 °C
- Rouge = plus de 27 °C
- Compris dans la livraison : câble de charge micro USB
- Batterie lithium-ions
- Durée maximale d'éclairage : env. 45 heures (avec la batterie pleinement chargée)

### CARACTERÍSTICAS TÉCNICAS

- Las diferentes temperaturas ambiente se muestran en una pantalla inteligente en color.
- Azul = menos de 14 grados Celsius
- Verde = entre 15 y 20 grados Celsius
- Naranja = entre 21 y 26 grados Celsius
- Rojo = más de 27 grados Celsius
- Incluido en la alcance de suministro: cable de carga micro USB
- Batería de iones de litio, 3,7 V, 500 mAh
- Tiempo máximo de iluminación: aprox. 45 horas (con la batería completamente cargada)
- Sin PVC

Ref. No. Référence Referencia	EAN 4003318	Variants Exécutions Variantes	Finish Coloris Color	Box Quantity Unité d'emballage Cantidad de cajas
JC8650 LILY	73155 6	Night light with temperature display	white	1

# JC8660 JULIE

## LED NIGHT LIGHT



### TECHNOLOGY AND FEATURES

- 1 charging unit with LED light – connects to socket for contactless charging, 1 portable unit with LED emergency light and torch
- Energy saving: Uses 2 x 0.5 watt LEDs, LED colour temperature: 6,500 K
- 5-in-1 functions:
- Calming night light
- Torch
- Emergency light
- Twilight sensor The light switches on depending on the ambient lighting
- Motion sensor: Movement switches the light on – motion detection in a 120 degrees angle and approx. 5.5 metre distance

### CARACTÉRISTIQUES TECHNIQUES

- 1 unité de charge avec éclairage LED – raccordement sur une prise pour une recharge sans contact, 1 unité portable avec éclairage d'urgence LED et lampe torche
- Basse consommation : Fonctionne avec des LED 2 x 0,5 watt, température de couleur des LED : 6 500 K
- Fonction 5-en-1 :
- Veilleuse apaisante
- Lampe torche
- Éclairage d'urgence
- Capteur d'obscurité : la lumière est adaptée à la luminosité de l'environnement
- Capteur de mouvement : la lumière est adaptée au mouvement – détection de mouvement selon un angle de 120 degrés et à une distance d'env. 5,5 mètres

### CARACTERÍSTICAS TÉCNICAS

- 1 unidad de carga con luz LED, se conecta a los enchufes para la carga sin contacto; 1 unidad portátil con luz LED de emergencia y linterna
- Ahorro de energía: consumo de los LED 2 x 0,5 vatios; temperatura de color del LED: 6500K
- Función 5 en 1:
- luz nocturna relajante
- Linterna
- Luz de emergencia
- Sensor crepuscular: la luz se regula en función de la luminosidad del entorno
- Sensor de movimiento: la luz se regula en función del movimiento; detección de movimiento en un ángulo de 120 grados y a unos 5,5 metros de distancia
- Temperatura de la luz 6.500 Kelvin
- Sin PVC

Ref. No. Référence Referencia	EAN 4003318	Variants Exécutions Variantes	Finish Coloris Color	Box Quantity Unité d'emballage Cantidad de cajas
JC8660 JULIE	73163 1	LED Night light	white	1

# JC8630 LORI

## NIGHT LIGHT



### TECHNOLOGY AND FEATURES

- On/off switch on the night light (slide switch)
- LED light: 1 x 0.5 Watt
- Connection to 230V socket
- PVC free

### CARACTÉRISTIQUES TECHNIQUES

- Interrupteur marche/arrêt de la veilleuse (interrupteur à glissière)
- Lumière LED : 1 x 0,5 Watt
- Raccordement à la prise 230 V
- Sans PVC

### CARACTERÍSTICAS TÉCNICAS

- Interruptor de encendido/apagado de la luz nocturna (interruptor deslizante)
- Luz LED: 1 x 0,5 vatios
- Conexión a la toma de corriente de 230 V
- Sin PVC

Ref. No. Référence Referencia	EAN 4003318	Variants Exécutions Variantes	Finish Coloris Color	Box Quantity Unité d'emballage Cantidad de cajas
JC8630 LORI	73162 4	Night light	white	1

# JC1300 JANITA

## BED COVER HOLDER



### TECHNOLOGY AND FEATURES

- For stanchions up to 18 millimetres
- High-quality plastic; painted surfaces are undamaged
- Universal use – fits all current children's beds
- Easy to fit

### CARACTÉRISTIQUES TECHNIQUES

- Pour les barreaux jusqu'à 18 millimètres
- Plastique haut de gamme : ne détériore pas les surfaces vernies
- Utilisation universelle – adapté à tous les lits pour enfant courants
- Mise en place simple

### CARACTERÍSTICAS TÉCNICAS

- Para barras de hasta 18 milímetros
- Plástico de alta calidad: las superficies pintadas permanecen intactas
- Instalación universal: apta para todas las camas infantiles actuales
- Colocación sencilla
- Sin PVC
- Alcance de suministro: 4 unidades

Ref. No. Référence Referencia	EAN 4003318	Variants Exécutions Variantes	Finish Coloris Color	Box Quantity Unité d'emballage Cantidad de cajas
JC1300 JANITA	73160 0	Bed cover holder	grey	1

# JC9100 ERIC

## BED GUARD



### TECHNOLOGY AND FEATURES

- Sturdy construction
- Easy to assemble and dismantle: perfect for at home and away
- Cover: high-quality silk, washable at 30 degrees Celsius

### CARACTÉRISTIQUES TECHNIQUES

- Construction robuste
- Montage et démontage faciles : idéale à la maison et en déplacement
- Housse : soie haut de gamme, lavable à 30 °C

### CARACTERÍSTICAS TÉCNICAS

- Estructura muy robusta
- Montaje y desmontaje sin complicaciones gracias al sistema insertable: ideal para casa y para viajar
- Tamaño XXL: 150 cm de ancho
- Protección anticaídas extraalta: 42 cm
- Funda de alta calidad y duradera, lavable a 30 grados
- Sin PVC

Ref. No. Référence Referencia	EAN 4003318	Variants Exécutions Variantes	Finish Coloris Color	Box Quantity Unité d'emballage Cantidad de cajas
JC9100 ERIC white	73127 3	Bed guard	white	1
JC9100 ERIC grey	87547 2	Bed guard	grey	1
JC9100 ERIC blue	87546 5	Bed guard	blue	1

# JC8740 PIA

## DIGITAL BATH AND SHOWER THERMOMETER WITH ALARM



### TECHNOLOGY AND FEATURES

- Over 41 degrees Celsius, warns against water temperature that is too hot in the shower or bath
- Activated by motion sensor
- Auto off after approx. one hour
- Included in the scope of delivery: 2 x LR44 batteries

### CARACTÉRISTIQUES TECHNIQUES

- Avertit en cas de température d'eau trop élevée dans la douche et le bain à partir de 41 °C
- Activation par détecteur de mouvement
- Arrêt automatique après env. une heure
- Compris dans la livraison : 2 x piles LR44

### CARACTERÍSTICAS TÉCNICAS

- Advierte de temperaturas del agua demasiado altas a partir de los 41 grados Celsius en duchas y bañeras
- Activación mediante sensor de movimiento
- Desconexión automática tras una hora aprox.
- Apto para conexiones de flexo de 1/2"
- Incluido en la alcance de suministro: 2 pilas LR44
- Sin PVC

Ref. No. Référence Referencia	EAN 4003318	Variants Exécutions Variantes	Finish Coloris Color	Box Quantity Unité d'emballage Cantidad de cajas
JC8740 PIA	73156 3	Digital bath and shower thermometer	white	1

# JC8720 ROBBI

## DIGITAL BATH THERMOMETER WITH TIMER AND CLOCK



### TECHNOLOGY AND FEATURES

- Warns of lower than 30 degrees Celsius / more than 37 to 40 degrees Celsius (individually adjustable)
- Integrated clock and timer
- The timer starts with contact to water
- Stopwatch function
- Included in the package: 2 x LR44 batteries

### CARACTÉRISTIQUES TECHNIQUES

- Avertit en cas de température inférieure à 30 °C/supérieure à 37 à 40 °C (réglable individuellement)
- Horloge et minuteur intégrés
- Le minuteur démarre au contact de l'eau
- Fonction chronomètre
- Incluses : 2 x piles LR44

### CARACTERÍSTICAS TÉCNICAS

- Avis de las temperaturas demasiado bajas y demasiado altas: por debajo de 30 grados Celsius/por encima de entre 37 y 40 grados Celsius (ajustable individualmente)
- Reloj y temporizador incorporados
- El temporizador se pone en marcha al entrar en contacto con el agua
- Función de cronómetro
- Se incluyen: 2 pilas LR44
- Sin PVC

Ref. No. Référence Referencia	EAN 4003318	Variants Exécutions Variantes	Finish Coloris Color	Box Quantity Unité d'emballage Cantidad de cajas
JC8720 ROBBI	73157 0	Digital bath thermometer	blue	1

## BATH THERMOMETER



### TECHNOLOGY AND FEATURES

- Measuring range from 0 to 50 °C.
- Without plasticisers (bisphenol A) and mercury

### CARACTÉRISTIQUES TECHNIQUES

- Plage de mesure de 0 à 50 °C.
- Sans plastifiants (bisphénol A) et sans mercure

### CARACTERÍSTICAS TÉCNICAS

- Rango de medición de 0 a 50 °C.
- Sin plastificantes (bisfenol A) ni mercurio

Ref. No. Référence Referencia	EAN 4003318	Variants Exécutions Variantes	Finish Coloris Color	Box Quantity Unité d'emballage Cantidad de cajas
JC8730 Emil	90112 6	Bath thermometer	blue	1

# JC8710 KIM

## NON-SLIP BATH STICKER



### TECHNOLOGY AND FEATURES

- 2 x 5 different, various-coloured animal designs
- Adhesive installation: self-adhesive reverse side

### CARACTÉRISTIQUES TECHNIQUES

- 2 x 5 motifs d'animaux différents et de différentes couleurs
- Montage par collage : verso autocollant

### CARACTERÍSTICAS TÉCNICAS

- Pegatinas de baño antideslizantes y autoadhesivas, disponibles en cinco diseños diferentes.
- Montaje adhesivo: parte trasera autoadhesiva
- Alcance de suministro: 2 x 5 unidades
- Sin PVC

Ref. No. Référence Referencia	EAN 4003318	Variants Exécutions Variantes	Finish Coloris Color	Box Quantity Unité d'emballage Cantidad de cajas
JC8710 KIM	73131 0	Non-slip bath sticker		1



## ROBUST TOILET TRAINER



### TECHNOLOGY AND FEATURES

- Two strong grab handles provide more safety
- Comfortable and secure fit
- Thanks to rotatable elements, very easy to adjust to standard toilets (position C: approx. 14,5 cm, position D: approx. 15,5 cm, without – approx. 18 cm)
- Dimensions (L/W/H): 25 x 23 x 8 cm
- Bisphenol-A free plastic

### CARACTÉRISTIQUES TECHNIQUES

- Deux poignées robustes pour plus de sécurité
- Ajustement confortable et sûr
- Grâce aux éléments rotatifs, il s'adapte très facilement aux toilettes standard (position C : environ 14,5 cm, position D : environ 15,5 cm, sans - environ 18 cm)
- Dimensions (L/H) : 25 x 23 x 8 cm
- Plastique sans bisphénol A

### CARACTERÍSTICAS TÉCNICAS

- Dos robustas asas de agarre proporcionan más seguridad
- Ajuste cómodo y seguro
- Gracias a los elementos giratorios, se ajusta muy fácilmente a los inodoros estándar (posición C: aprox. 14,5 cm, posición D: aprox. 15,5 cm, ninguna: aprox. 18 cm)
- Dimensiones (L/An/AI): 25 x 23 x 8 cm
- Plástico sin bisfenol A

Ref. No. Référence Referencia	EAN 4003318	Variants Exécutions Variantes	Finish Coloris Color	Box Quantity Unité d'emballage Cantidad de cajas
JC8700 Malte	90128 7	Robust toilet trainer	grey-white	1

# JC6416 LARA

## UNIVERSAL REFLECTOR STICKER



### TECHNOLOGY AND FEATURES

- 24 millimetres x 4 metres, 16 pieces
- Adhesive installation
- Visibility: approx. 150 metres
- Sticks to various materials

### CARACTÉRISTIQUES TECHNIQUES

- Contenu de l'emballage: 16 pièces
- Fixation par collage facile
- Visibilité des réflecteurs: env. 150 m
- Bâtons à différents matériaux

### CARACTERÍSTICAS TÉCNICAS

- 16 unidades (2 unidades de 87 x 20mm y 87 x 15mm, 4 unidades de 87 x 12mm, 8 unidades de 43 x 12mm)
- Montaje adhesivo
- Visibilidad: aprox. 150 metros
- Se adhiere a diferentes superficies

Ref. No. Référence Referencia	EAN 4003318	Variants Exécutions Variantes	Finish Coloris Color	Box Quantity Unité d'emballage Cantidad de cajas
JC6416 LARA	73146 4	Universal reflector sticker		18

# JC6412 MIKE

## CHILD'S BUGGY REFLECTOR



### TECHNOLOGY AND FEATURES

- Scope of delivery: 2 x reflectors, 12 x 12 centimetres
- Reflector visibility: approx. 150 metres
- Velcro fastener: Fitting is child's play
- Cleaning: Hand wash

### CARACTÉRISTIQUES TECHNIQUES

- Contenu de la livraison : 2 réflecteurs, 12 x 12 centimètres
- Visibilité du réflecteur : env. 150 mètres
- Fixation velcro : la mise en place est un jeu d'enfant
- Nettoyage : lavage à la main

### CARACTERÍSTICAS TÉCNICAS

- Alcance de suministro: 2 reflectores, 12 x 12 centímetros
- Visibilidad del reflector: aprox. 150 metros
- Cierre de velcro: colocación muy sencilla
- Limpieza: lavado a mano
- Sin PVC

Ref. No. Référence Referencia	EAN 4003318	Variants Exécutions Variantes	Finish Coloris Color	Box Quantity Unité d'emballage Cantidad de cajas
JC6412 MIKE	73159 4	Child's buggy reflector	yellow	1

# JC6408 HANNA

**NEW**

## SNAP HOOKS



### TECHNOLOGY AND FEATURES

- Made of durable aluminium, robust and strong
- Robust Velcro strap with 50 mm width
- Carabiner passage approx. 35 mm
- Content: 2 items

### CARACTÉRISTIQUES TECHNIQUES

- Fabriqué en aluminium durable, robuste et stable
- Bande velcro robuste de 50 mm de large
- Passage du mousqueton d'environ 35 mm
- Contenu : 2 pièces

### CARACTERÍSTICAS TÉCNICAS

- Fabricado en aluminio duradero, robusto y estable
- Robusta cinta de velcro de 50 mm de ancho
- Paso del mosquetón aprox. 35 mm
- Contenido: 2 unidades

Ref. No. Référence Referencia	EAN 4003318	Variants Exécutions Variantes	Finish Coloris Color	Box Quantity Unité d'emballage Cantidad de cajas
JC6408 Hanna	90118 8	Snap hooks Set of 2	black	1

## RAIN COVER FOR PRAMS



### TECHNOLOGY AND FEATURES

- All-round reflective edging ensures that you and your baby are seen even better in the dark by car headlights and other road users.
- Large ventilation hole for very good air circulation and access to the child in the pram
- Small canopy over the opening provides additional protection
- Elastic band at the bottom fixes the rain cover in place
- Free of PVC and plasticisers, odourless

### CARACTÉRISTIQUES TECHNIQUES

- Les bordures réfléchissantes sur tout le pourtour permettent à vous et à votre bébé d'être encore mieux vus dans l'obscurité par les phares des voitures et les autres usagers de la route.
- Grand trou de ventilation pour une très bonne circulation de l'air et un accès à l'enfant dans la poussette
- Un petit auvent au-dessus de l'ouverture offre une protection supplémentaire
- Une bande élastique en bas fixe la protection contre la pluie en place
- Sans PVC ni plastifiants, inodore

### CARACTERÍSTICAS TÉCNICAS

- Los bordes reflectantes en todo el contorno garantizan una mejor visibilidad para usted y su bebé en la oscuridad, a la luz de los faros de los coches y otros vehículos.
- Gran orificio de ventilación para una excelente circulación del aire y acceso al niño en el cochecito
- La pequeña visera sobre la apertura proporciona protección adicional
- La banda elástica de la parte inferior mantiene fija la protección contra la lluvia
- Sin PVC ni plastificantes, sin olor

Ref. No. Référence Referencia	EAN 4003318	Variants Exécutions Variantes	Finish Coloris Color	Box Quantity Unité d'emballage Cantidad de cajas
JC6420 Tessa	90102 7	Rain cover for prams	transparent	1

## SUN PROTECTOR



### TECHNOLOGY AND FEATURES

- UV protection 50+ according to Australian-New Zealand standard, absorbs 97.5% of dangerous UV rays
- Material: 100 % polyester (soft surface)
- Dimensions approx. 64 x 47 (30) cm
- Variable settings to the left or right depending on the sunlight

### CARACTÉRISTIQUES TECHNIQUES

- Protection UV 50+ selon la norme australienne et néo-zélandaise, absorbe 97,5 % des rayons UV dangereux
- Matériau : 100 % polyester (surface souple)
- Dimensions : 64 x 47 (30) cm environ
- Réglages variables à gauche ou à droite en fonction de l'ensoleillement

### CARACTERÍSTICAS TÉCNICAS

- Protección UV 50+ según la norma australiana-neozelandesa, absorbe el 97,5 % de los rayos UV peligrosos
- Material: 100 % poliéster (superficie suave)
- Dimensiones aprox. 64 x 47 (30) cm
- Ajustes variables a la izquierda o a la derecha en función de la luz del sol

Ref. No. Référence Referencia	EAN 4003318	Variants Exécutions Variantes	Finish Coloris Color	Box Quantity Unité d'emballage Cantidad de cajas
JC6440 Linda	90107 2	Sun protector	anthracite	1

## INSECT PROTECTOR UNIVERSAL FOR PRAMS



### TECHNOLOGY AND FEATURES

- Simple attachment and secure hold thanks to all-round elastic band
- Material: 100% polyester

### CARACTÉRISTIQUES TECHNIQUES

- Fixation simple et maintien sûr grâce à la bande élastique périphérique
- Matériau : 100% polyester

### CARACTERÍSTICAS TÉCNICAS

- Fijación sencilla y sujeción segura gracias a la banda elástica integral
- Material: 100 % poliéster

Ref. No. Référence Referencia	EAN 4003318	Variants Exécutions Variantes	Finish Coloris Color	Box Quantity Unité d'emballage Cantidad de cajas
JC6460 Maya	90108 9	Insect protector universal for prams	grey	1

# JC6324 ZOE

## ANTI-SLIP TAPE



### TECHNOLOGY AND FEATURES

- 24 millimetres x 4 metres, can be cut to size

### CARACTÉRISTIQUES TECHNIQUES

- 24 millimètres x 4 mètres, découpable

### CARACTERÍSTICAS TÉCNICAS

- 24 milímetros x 4 metros, se puede cortar a medida, autoadhesiva
- Color negro

Ref. No. Référence Referencia	EAN 4003318	Variants Exécutions Variantes	Finish Coloris Color	Box Quantity Unité d'emballage Cantidad de cajas
JC6324 ZOE	73145 7	Anti-slip tape	black	1

## ROLLABLE DOOR/STAIR GATE



### TECHNOLOGY AND FEATURES

- JC9514
- Tested according to European standard DIN EN 1930:2011
  - Maximum width of doors/passages: 140 cm
  - Extra high net (approx. 85 cm)
- JC9518
- Compensates for height differences up to 20 mm
  - 3 bases per side (left and right) included in the set
  - 3 mm, 6 mm, 9 mm
  - Includes longer screws and matching dowels

### CARACTÉRISTIQUES TECHNIQUES

- JC9514
- Testé selon la norme européenne DIN EN 1930:2011
  - Largeur maximale des portes/passages : 140 cm
  - Filet extra haut (environ 85 cm)
- JC9518
- Testé selon la norme européenne DIN EN 1930:2011
  - Largeur maximale des portes/passages : 140 cm
  - Filet extra haut (environ 85 cm)

### CARACTERÍSTICAS TÉCNICAS

- JC9514
- Testé selon la norme européenne DIN EN 1930:2011
  - Largeur maximale des portes/passages : 140 cm
  - Filet extra haut (environ 85 cm)
- JC9518
- Compensa diferencias de altura de hasta 20 mm
  - El juego incluye 3 soportes para cada lado (izquierda y derecha)
  - 3 mm, 6 mm, 9 mm
  - Incl. tornillos más largos y los tacos correspondientes

Ref. No. Référence Referencia	EAN 4003318	Variants Exécutions Variantes	Finish Coloris Color	Box Quantity Unité d'emballage Cantidad de cajas
JC9514 Ben	90126 3	Rollable door/stair gate	Net: black, Plastic holder: grey	1
JC9518 Ben Bases	90272 7	Bases 3-6-9mm (Set of 2)	grey	1

# JC9220 NIC

## WOODEN STAIR GATE



### TECHNOLOGY AND FEATURES

- Completely assembled in a few minutes
- Made of untreated, European beech wood
- Natural raw material without lacquers
- Up to door widths and stairways from 63 to 103.5 cm
- Height of the gate from the floor approx. 72 cm
- Distance between the bars: approx. 50 mm

### CARACTÉRISTIQUES TECHNIQUES

- Entièrement montée en quelques minutes
- Fabriquée en bois de hêtre européen non traité
- Matière première naturelle sans vernis
- Jusqu'à des largeurs de portes et d'escaliers de 63 à 103,5 cm
- Hauteur de la barrière depuis le sol environ 72 cm
- Distance entre les barreaux de la grille : env. 50 mm

### CARACTERÍSTICAS TÉCNICAS

- Montaje completo en pocos minutos
- Fabricada en madera de haya europea no tratada
- Materia prima natural sin pinturas
- Anchos de puertas y escaleras de entre 63 y 103,5 cm
- Altura de la barrera desde el suelo aprox. 72 cm
- Distancia entre las barras: aprox. 50 mm

Ref. No. Référence Referencia	EAN 4003318	Variants Exécutions Variantes	Finish Coloris Color	Box Quantity Unité d'emballage Cantidad de cajas
JC9220 Nic	90115 7	Wooden stair gate	beech	1

# JC9308 LOU

## INSTALLATION ADAPTER ON STAIR GATE FOR "FINN"



### TECHNOLOGY AND FEATURES

- The stair gate FINN can be extended by 8.5 centimetres per side
- Easy assembly
- PVC free

### CARACTÉRISTIQUES TECHNIQUES

- Accessoire en option permettant de rallonger la barrière d'escalier FINN de 8,5 cm

### CARACTERÍSTICAS TÉCNICAS

- La barrera para escalera FINN puede ampliarse 8,5 centímetros a cada lado
- Montaje sencillo
- Sin PVC

Ref. No. Référence Referencia	EAN 4003318	Variants Exécutions Variantes	Finish Coloris Color	Box Quantity Unité d'emballage Cantidad de cajas
JC9308 LOU	73152 5	Installation adapter on stair gate	white	1

# JC9203 HENRY

## Y SPINDLE FOR INSTALLING "FINN" ON STAIR RAILS



### TECHNOLOGY AND FEATURES

- Installation with no drilling required
- Simple installation: clamped on

### CARACTÉRISTIQUES TECHNIQUES

- Montage sans perçage !
- Montage facile : par pression

### CARACTERÍSTICAS TÉCNICAS

- Montaje sin taladrar.
- Montaje sencillo
- Sin PVC
- Alcance de suministro: 2 unidades

Ref. No. Référence Referencia	EAN 4003318	Variants Exécutions Variantes	Finish Coloris Color	Box Quantity Unité d'emballage Cantidad de cajas
JC9203 HENRY	73154 9	Stair adapter	white	1

# JC9330 FINN

## METAL DOOR AND STAIR GATE



### TECHNOLOGY AND FEATURES

- The width can be adjusted from 73 to 81.5 centimetres
- Recommended minimum distance between door and stair gate and wall/stair posts: Minimum 12 millimetres, maximum distance: 62 millimetres
- Accessories for installing on stairs and wall: available separately
- Tested according to: DIN1930:2011
- Extension by 8.5 centimetres available

### CARACTÉRISTIQUES TECHNIQUES

- Peut être installée de façon variable sur une largeur de 73 à 81,5 centimètres.
- Distance minimale recommandée entre les barrières de porte/d'escalier et le mur/les barreaux d'escalier : minimum 12 millimètres, distance maximale : 62 millimètres
- Accessoire pour un montage sur des escaliers et un mur : disponible séparément
- Contrôlée d'après : la norme DIN 1930:2011

### CARACTERÍSTICAS TÉCNICAS

- Puede ajustarse de forma variable a una anchura de ente 73 y 81,5 centímetros
- Distancia mínima recomendada entre la barrera para puertas y escaleras y las barras de la pared/escalera: mínimo 12 milímetros, distancia máxima: 62 milímetros
- Probado según: DIN1930:2011
- También se puede utilizar en escaleras (de dúplex) con el adaptador de escalera HENRY
- Puede ampliarse 8,5 centímetros a cada lado con la extensión de barrera para escalera LOU
- Sin PVC

Ref. No. Référence Referencia	EAN 4003318	Variants Exécutions Variantes	Finish Coloris Color	Box Quantity Unité d'emballage Cantidad de cajas
JC9330 FINN	73150 1	Metal door and stair gate	white	1

# JC9210 TIM

## METAL DOOR AND STAIR GATE

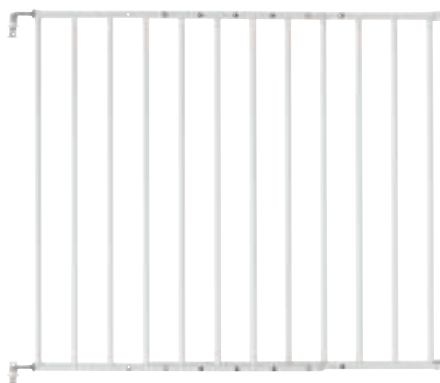

### TECHNOLOGY AND FEATURES

- The width can be adjusted from 60 to 107 centimetres
- Recommended minimum distance between door and stair gate and wall/stair posts: 12 millimetres. Maximum distance: 62 millimetres
- Tested according to: DIN1930:2011

### CARACTÉRISTIQUES TECHNIQUES

- Peut être installée de façon variable sur une largeur de 60 à 107 centimètres
- Distance minimale recommandée entre les barrières de porte/d'escalier et le mur/les barreaux d'escalier : 12 millimètres. Distance maximale : 62 millimètres
- Contrôlée d'après : la norme DIN 1930:2011

### CARACTERÍSTICAS TÉCNICAS

- Puede ajustarse de forma variable a una anchura de 60 a 107 centímetros
- Distancia mínima recomendada entre la barrera para puertas y escaleras y las barras de la pared/escalera: 12 milímetros. Distancia máxima: 62 milímetros
- Probado según: DIN1930:2011
- Sin PVC

Ref. No. Référence Referencia	EAN 4003318	Variants Exécutions Variantes	Finish Coloris Color	Box Quantity Unité d'emballage Cantidad de cajas
JC9210 TIM	73151 8	Metal door and stair gate	white	1

## FIREPLACE GUARD



### TECHNOLOGY AND FEATURES

- Incl. 5 panels and brackets for wall mounting
- Total length: 375 cm
- Height of the fireplace guard: 74 cm
- Total length of all elements: 375 cm
- Height of the fireplace guard: 74 cm
- Distance between the bars: approx. 60 mm

### CARACTÉRISTIQUES TECHNIQUES

- Incluant 5 panneaux et des supports pour le montage mural
- Longueur totale : 375 cm
- Hauteur de la grille de protection pour foyers : 74 cm
- Longueur totale de tous les éléments : 375 cm
- Hauteur de la grille de protection pour foyers : 74 cm
- Distance entre les barreaux de la grille : env. 60 mm

### CARACTERÍSTICAS TÉCNICAS

- Incluye 5 paneles y soportes para el montaje en la pared
- Longitud total: 375 cm
- Altura del protector de chimenea: 74 cm
- Longitud total de todos los elementos: 375 cm
- Altura del protector de chimenea: 74 cm
- Distancia entre las barras: aprox. 60 mm

Ref. No. Référence Referencia	EAN 4003318	Variants Exécutions Variantes	Finish Coloris Color	Box Quantity Unité d'emballage Cantidad de cajas
JC9500 Felix	90113 3	Fireplace guard	grey	1

# JC3100A DENNY

## EDGE GUARD



### TECHNOLOGY AND FEATURES

- 4 x edge guard
- Simple installation with 3M adhesive pad (included in the scope of delivery)



### CARACTÉRISTIQUES TECHNIQUES

- 4 x Protection de rebord
- Montage facile grâce à un autocollant 3M (fourni)

### CARACTERÍSTICAS TÉCNICAS

- Protege a bebés y niños pequeños de lesiones con los bordes de mesas o armarios
- Fácil montaje gracias a los adhesivos 3M (incluidos en la alcance de suministro)
- Alcance de suministro: 4 unidades
- Sin PVC

Ref. No. Référence Referencia	EAN 4003318	Variants Exécutions Variantes	Finish Coloris Color	Box Quantity Unité d'emballage Cantidad de cajas
JC3100A DENNY	76966 5	Edge guard	grey	1



# JC3400A TOBI

## EDGE GUARD



### TECHNOLOGY AND FEATURES

- 4 x edge guard
- Simple installation with 3M adhesive pad (included in the scope of delivery)

### CARACTÉRISTIQUES TECHNIQUES

- 4 x protection de rebord
- Montage facile grâce à un autocollant 3M (fourni)

### CARACTERÍSTICAS TÉCNICAS

- Protege a bebés y niños pequeños de lesiones con los bordes de mesas o armarios
- Fácil montaje gracias a los adhesivos 3M (incluidos en la alcance de suministro)
- Sin PVC
- Alcance de suministro: 4 unidades

Ref. No. Référence Referencia	EAN 4003318	Variants Exécutions Variantes	Finish Coloris Color	Box Quantity Unité d'emballage Cantidad de cajas
JC3400A TOBI	76967 2	Edge guard	transparent	1

# JC3500 JANNIC

## EDGE GUARD



### TECHNOLOGY AND FEATURES

- 4 x corner guard
- Soft foam, high damping
- Simple adhesive mounting (3M sticky pad)
- Tip: extend with Peter edge protector

### CARACTÉRISTIQUES TECHNIQUES

- 4 x protection des coin
- Mousse douce, amortissement élevé
- Fixation par collage facile (autocollant de 3M)
- Conseil : utilisable en complément de la protection de rebord Peter

### CARACTERÍSTICAS TÉCNICAS

- Espuma muy blanda = alta amortiguación
- Fácil montaje gracias a los adhesivos 3M (incluidos en la entrega)
- Alcance de suministro: 4 unidades
- Sin PVC

Ref. No. Référence Referencia	EAN 4003318	Variants Exécutions Variantes	Finish Coloris Color	Box Quantity Unité d'emballage Cantidad de cajas
JC3500 JANNIC	73138 9	Edge guard	vanilla	1

# JC3624 PETER

## EDGE PROTECTION



### TECHNOLOGY AND FEATURES

- 1 x edge protector, length: 2,4 metres - Can be cut to a specific length
- Soft foam, high damping
- Simple installation with 3M sticky pad
- Tip: extend with Jannic corner guard

### CARACTÉRISTIQUES TECHNIQUES

- 1 x protection de rebord, longueur : 2,4 mètres - Découpable à la longueur voulue
- Mousse douce, amortissement élevé
- Montage facile grâce à un autocollant 3M (fourni)
- Conseil : utilisable en complément de la protection de coin Jannic

### CARACTERÍSTICAS TÉCNICAS

- 1 protector de bordes, longitud: 2,4 metros, se puede cortar a medida
- Espuma muy blanda = alta amortiguación
- Fácil montaje gracias a los adhesivos 3M (incluidos en la entrega)
- Sin PVC

Ref. No. Référence Referencia	EAN 4003318	Variants Exécutions Variantes	Finish Coloris Color	Box Quantity Unité d'emballage Cantidad de cajas
JC3624 PETER	73139 6	Edge protection	vanilla	1

# JC3700 ROBIN

**NEW**

## CORNER GUARD



### TECHNOLOGY AND FEATURES

- PVC-free
- Content: 4 piece

### CARACTÉRISTIQUES TECHNIQUES

- Sans PVC
- Contenu : 4 pièces

### CARACTERÍSTICAS TÉCNICAS

- Sin PVC
- Contenido: 4 unidades

Ref. No. Référence Referencia	EAN 4003318	Variants Exécutions Variantes	Finish Coloris Color	Box Quantity Unité d'emballage Cantidad de cajas
JC3700 Robin	90096 9	Corner guard	transparent	1



# SMOKE ALARM DEVICE



RWM90



RWM250



RWM450



RWM150



RWM160



RWM165

<b>Heat</b>	-	yes	yes	-	-	-
<b>Radio interlinked</b>	-	-	yes	-	-	yes
<b>Easy adhesive mounting</b>	-	yes	yes	-	-	-
<b>Fixed battery</b>	-	yes	yes	yes	yes	yes
<b>Battery life in years</b>	5	12	12	~ 10	10	10
<b>Hush-function</b>	yes	yes	yes	yes	yes	yes
<b>Certification</b>	-	Kriwan / Q	Kriwan / Q	VdS / Q	CNPP / Q	VdS / Q
<b>Standards</b>	EN 14604	EN 14604 / vfdb 14-01	EN 14604 / vfdb 14-01	EN 14604 / VdS 3131	EN14604 / vfdb 14-01	EN 14604 / VdS 3515

# RWM90

## SMOKE ALARM DEVICE



### TECHNOLOGY AND FEATURES

- Detection range: up to 40 m<sup>2</sup> in a room
- A loud 85 dB alarm
- Replaceable 3 volt lithium battery CR123A
- Warning when battery level is low
- Regular self-testing with automatic error message
- Hush function for 9 minutes
- Verified in accordance with DIN EN 14604
- Up to 5 years battery life

### CARACTÉRISTIQUES TECHNIQUES

- Zone de couverture : 40 m<sup>2</sup> max. à l'intérieur d'une pièce
- Alarme sonore de 85 dB Pile au lithium 3 V CR123A remplaçable
- Avertissement lorsque la capacité de la pile diminue
- Autotest régulier avec message d'erreur automatique
- Option coupure du son pendant 9 minutes
- Conforme à DIN EN 14604
- Durée de vie de la pile max. 5 ans

### CARACTERÍSTICAS TÉCNICAS

- Área de detección: hasta 40 m<sup>2</sup> dentro de una habitación
- Alarma potente de 85 dB Pila de litio de 3 voltios CR123A reemplazable
- Aviso de pila baja
- Autocomprobación periódica con aviso de errores automático
- Opción de silencio durante 9 minutos
- Probado según DIN EN 14604
- Vida útil de la pila de hasta 5 años

Ref. No. Référence Referencia	EAN 4003318	Variants Exécutions Variantes	Battery Pile Pila	Finish Coloris Color	Box Quantity Unité d'emballage Cantidad de cajas
RWM90	89520 3	Smoke alarm device	3V lithium battery - CR123A	white	1
RWM90 Twins	39973 2	Smoke alarm device	3V lithium battery - CR123A	white	

# RWM250

## STAND-ALONE SMOKE ALARM DEVICE WITH HEAT ALARM FUNCTION



### TECHNOLOGY AND FEATURES

- Q-mark certified by KRIWAN TESTZENTRUM
- Certified according to EN14604:2005/AC:2008
- Extended test according to vfdb14-01
- Made in Germany
- Alert for smoke + heat
- 3V lithium battery, solid-state, 12-year battery life
- Quick and clean assembly without drilling
- Dimensions: 10,5 cm diameter, 4,0 cm height
- 88 dB alarm
- LED-display

### CARACTÉRISTIQUES TECHNIQUES

- Certification Q par KRIWAN TESTZENTRUM
- Conforme à EN14604:2005/AC:2008
- Contrôle supplémentaire selon vfdb14-01
- Made in Germany
- Un capteur pour la détection optique des fumées et un capteur de température
- Pile au lithium 3 V fixe d'une durée de vie de 12 ans
- Fixation par collage facile grâce à la technique de patin adhésif gel aimanté avec fixation supplémentaire en option (film adhésif fin double face) selon la norme vfdb 14-01 (Q)
- Dimensions : Ø 10,5 cm, hauteur 4 cm
- Alarme „88 dB”
- Conformité CE 1772-CPR-150086
- Installation rapide et pratique sans perceuse
- Pile au lithium 3V, résistante
- Alerte fumée + chaleur
- Adapté à la cuisine
- Durée de vie des piles de 12 ans

### CARACTERÍSTICAS TÉCNICAS

- Homologado con el sello Q por el CENTRO DE PRUEBAS KRIWAN
- Probado según EN14604:2005/AC:2008
- Prueba ampliada según vfdb14-01
- Made in Germany
- Incorpora un sensor para la detección óptica de humo y otro sensor para la medición de temperatura
- Pila de litio de 3 voltios integrada con 12 años de vida útil
- Fijación sencilla mediante tecnología de fijación adhesiva de contacto magnético que incorpora opcionalmente un elemento de fijación (una fina película adhesiva doble) en virtud de la directiva 14-01 (Q) de la Asociación Alemana Anti incendios (vfdb, por sus siglas en alemán)
- Medidas: 10,5 cm de Ø, 4,0 cm de alto
- Volumen de la alarma: 88 dB

Ref. No. Référence Referencia	EAN 4003318	Variants Exécutions Variantes	Battery Pile Pila	Finish Coloris Color	Box Quantity Unité d'emballage Cantidad de cajas
RWM250	09386 9	Stand-alone Smoke alarm device with heat alarm function	3V lithium battery, solid state	pure white	1

# RWM450 FUNK

## WIRELESS SMOKE ALARM DEVICE WITH HEAT ALARM FUNCTION



### TECHNOLOGY AND FEATURES

- Q-mark certified by KRIWAN TESTZENTRUM
- Certified according to EN14604:2005/AC:2008
- Extended test according to vfdb14-01
- Made in Germany
- One sensor for optical smoke detection and one sensor for temperature measurement
- Firmly installed 3V-lithium-battery with a lifespan of 12 years
- Frequency: 868,3 MHz
- Several smoke detectors can be linked wirelessly (via radio)
- Quick and clean assembly without drilling
- Dimensions: 10,5 cm diameter, 4,0 cm height
- „88 dB“ alarm
- Alert for smoke + heat
- Radio range 400 m (+/- 10 %) in the open
- Repeater function

### CARACTÉRISTIQUES TECHNIQUES

- Fréquence: 868,3 MHz
- Portée radio 400 m (+/- 10 %) champ libre
- Contrôle supplémentaire selon vfdb14-01
- Made in Germany
- Un capteur pour la détection optique des fumées et un capteur de température
- Livré avec une batterie au Lithium d'une durée de vie maximale de 12 ans
- Connexion sans fil, fréquence 868 MHz
- Possibilité de création de groupes connectés sans fil
- Fixation par collage facile grâce à la technique de patin adhésif gel aimanté avec moyen de fixation supplémentaire en option (film adhésif fin double face) selon la norme vfdb 14/01 (Q)
- Dimensions : Ø 10,5 cm, hauteur 4 cm
- Alarme „88 dB“
- Conformité CE 1772-CPR-150087
- Installation rapide et pratique sans perceu se
- Alerte fumée + chaleur
- Adapté à la cuisine
- Fonction répétition

### CARACTERÍSTICAS TÉCNICAS

- Homologado con el sello Q por el CENTRO DE PRUEBAS KRIWAN
- Probado según EN14604:2005/AC:2008
- Prueba ampliada según vfdb14-01
- Made in Germany
- Incorpora un sensor para la detección óptica de humo y otro sensor para la medición de temperatura
- Incluye pila de litio de 3 voltios integrada con una vida útil de 12 años
- Conexión inalámbrica, frecuencia de 868 MHz
- Posibilidad de formar grupos y comunidades inalámbricos
- Fijación sencilla con tecnología de fijación adhesiva de contacto magnético con elemento de fijación opcional (fina película adhesiva doble) según la directiva 14/01 (Q) de la Asociación Alemana Anti incendios (vfdb, por sus siglas en alemán)
- Medidas: 10,5 cm de Ø, 4,0 cm de alto
- Volumen de la alarma: 88 dB

Ref. No. Référence Referencia	EAN 4003318	Variants Exécutions Variantes	Battery Pile Pila	Finish Coloris Color	Box Quantity Unité d'emballage Cantidad de cajas
RWM450	09417 0	Wireless smoke alarm device with heat alarm function	3V lithium battery, solid state	pure white	1
RWM450 DFNL	78589 4	Wireless smoke alarm device with heat alarm function	3V lithium battery, solid state	pure white	1

# RWM150

## STAND-ALONE SMOKE ALARM DEVICE



### TECHNOLOGY AND FEATURES

- Detection range: up to 40 m<sup>2</sup> within a room
- Alarm volume: 85 dB
- Fixed 3 volt lithium battery, up to 10-year service life
- Warning in case of weak battery
- Regular self-testing with automatic error message
- Hush function for 9 minutes
- Dimensions: height: 36 mm, Ø 100 mm
- Recalibration in the event of soiling
- VdS-tested in accordance with DIN EN 14604 and VdS 3131

### CARACTÉRISTIQUES TECHNIQUES

- Zone de couverture : 40 m<sup>2</sup> max. à l'intérieur d'une pièce
- Volume de l'alarme : 85 dB
- Pile au lithium 3 V fixe, jusqu'à 10 ans de durée de vie
- Avertissement si la batterie est faible
- Autotest régulier avec message d'erreur automatique
- Option mode muet pendant 9 minutes
- Dimensions : Hauteur 36 mm, Ø 100 mm
- Nouveau calibrage en cas d'encrassement
- Homologué VdS, conforme à DIN EN 14604 et à la directive VdS 3131

### CARACTERÍSTICAS TÉCNICAS

- Área de detección: hasta 40 m<sup>2</sup> dentro de una habitación
- Volumen de la alarma: 85 dB
- Pila de litio de 3 voltios integrada, hasta 10 años de vida útil
- Aviso de pila baja
- Autocomprobación periódica con aviso de errores automático
- Opción de silencio durante 9 minutos
- Medidas: 36 mm de alto, 100 mm de Ø
- Recalibración en caso de suciedad
- Certificación VdS según DIN EN 14604 y la directiva VdS 3131

Ref. No. Référence Referencia	EAN 4003318	Variants Exécutions Variantes	Battery Pile Pila	Finish Coloris Color	Box Quantity Unité d'emballage Cantidad de cajas
RWM150	37242 1	Stand-alone Smoke device	3V lithium battery, solid state	pure white	1



## STAND-ALONE SMOKE ALARM DEVICE



### TECHNOLOGY AND FEATURES

- Quality tested according to Q (vfdb 14/01) and DIN EN 14604
- 10-year battery life – integrated low battery warning
- Ambient light detection, reduction of flashing at night
- Automatic self test
- Large test button for manual self-testing and test alarms
- Compact construction and appealing ultra-flat design
- Mute function
- Alarm with 85 decibels
- 40 square meter range

### CARACTÉRISTIQUES TECHNIQUES

- Contrôle de qualité selon Q (vfdb 14/01) et DIN EN 14604
- Durée de vie de la pile de 10 ans – avertissement si la pile est trop faible
- Détection de la lumière ambiante, réduction du clignotement la nuit
- Autotest automatique
- Grande touche de test pour procéder soi-même à un test manuel et déclencher l'alarme de test
- Conception compacte et design séduisant ultraplatt
- Mode silencieux
- Alarme de 85 décibels
- Portée 40 mètres carrés

### CARACTERÍSTICAS TÉCNICAS

- Calidad probada según Q (vfdb 14/01) y DIN EN 14604
- Pila con 10 años de vida útil; aviso en caso de batería baja
- Detección de la luz del entorno, reducción del parpadeo durante la noche
- Autocomprobación
- Pulsador de prueba de gran tamaño para autocomprobación manual y alerta de prueba
- Diseño compacto y diseño atractivo y ultraplano
- Función de silencio
- Alarma de 85 decibelios
- 40 metros cuadrados de alcance

Ref. No. Référence Referencia	EAN 4003318	Variants Exécutions Variantes	Battery Pile Pila	Finish Coloris Color	Box Quantity Unité d'emballage Cantidad de cajas
RWM160	67963 6	Stand-alone Smoke device	3V lithium battery, CR123A	white	1

# RWM165

## WIRELESS SMOKE ALARM DEVICE



### TECHNOLOGY AND FEATURES

- Q-Label certified by VdS
- 3 V lithium battery (built-in)
- 12 alarms can be linked per group
- 10-year battery life
- Alarm volume: 85 dB
- Hush function
- Regular self-testing with automatic error message
- Warning in case of weak battery
- Large test button
- Theft protection
- 868 MHz

### CARACTÉRISTIQUES TECHNIQUES

- Certification Q par VdS
- Pile lithium 3 V (montage fixe)
- Possibilité de connecter 12 détecteurs par groupe
- Durée de vie des piles de 10 ans
- Volume de l'alarme : 85 dB
- Option de coupure du son
- Autotest régulier avec message d'erreur automatique
- Avertit si la pile est faible
- Large touche de contrôle
- Protection contre les vols
- 868 MHz

### CARACTERÍSTICAS TÉCNICAS

- Sello Q homologado por VdS
- Posibilidad de conectar 12 detectores por grupo
- Batería integrada (3 V, de litio)
- Volumen de la alarma: 85 dB
- Opción de silencio
- Autocomprobación periódica con aviso de errores automático
- Advertencia acústica en caso de batería baja
- Tecla de comprobación de gran tamaño
- Protección antirrobo
- Frecuencia de radio de 868 MHz

Ref. No. Référence Referencia	EAN 4003318	Variants Exécutions Variantes	Battery Pile Pila	Finish Coloris Color	Box Quantity Unité d'emballage Cantidad de cajas
RWM165	73412 0	Wireless smoke alarm device	3V lithium battery, solid state	white	1

# GWM100ME

## METHANE GAS DETECTOR



KM682544  
BS EN 50194-1

### TECHNOLOGY AND FEATURES

- Tested and certified according to EN50194-1:2009
- Power supply: AC 220–240 V, 50 Hz/60 Hz
- Power consumption: < 4 W
- Dimensions: 115 x 75 x 36.5 mm
- Operating temperature: -10°C to +40°C
- Humidity: 0–95% rh
- Lifetime: 5 years
- Mute function
- Signal for end of lifespan
- The BSI Kitemark™ is a mark of quality and security

### CARACTÉRISTIQUES TECHNIQUES

- Vérifié et certifié selon EN50194-1:2009
- Alimentation électrique : 220-240 VCA, 50 Hz/60 Hz
- Consommation d'énergie : < 4 W
- Dimensions : 115 x 75 x 36,5 mm
- Température de fonctionnement : -10 °C – 40 °C
- Humidité de l'air : 0 – 95 % d'humidité relative
- Durée de vie : 5 ans
- Fonction coupure de son
- Signal pour la fin de la durée de vie
- BSI Kitemark™ – Label de qualité et de sécurité

### CARACTERÍSTICAS TÉCNICAS

- Probado y homologado según EN50194-1:2009
- Alimentación eléctrica: AC220-240V, 50 Hz/60 Hz
- Consumo de energía: < 4 W
- Medidas: 115 x 75 x 36.5 mm
- Temperatura de funcionamiento: -10° C – 40° C
- Humedad del aire: 0 – 95 % rF
- Vida útil: 5 años
- Función de silencio
- Señal de fin de la vida útil
- BSI Kitemark™: Distintivo de calidad y seguridad

Ref. No. Référence Referencia	EAN 4003318	Variants Exécutions Variantes	Battery Pile Pila	Finish Coloris Color	Box Quantity Unité d'emballage Cantidad de cajas
GWM100ME	81443 3	methane gas alarm	AC 220-240 V	white	1

## CO<sub>2</sub> DETECTOR



Product Video

### TECHNOLOGY AND FEATURES

- CO<sub>2</sub> sensor service life: max. 10 years
- OLED display
- LED colour display of the current air quality
- Power supply: AC adapter, input: AC 100~240 V, output: DC 5 V/1 A (Micro USB)
- Backup battery (Li-Ion 3.7 V)
- Date and time display
- Operating temperature: -10° to 40°C
- Humidity: 0 % to 95 % (non-condensing)
- Measurement range: CO<sub>2</sub>: 0-5,000 ppm
- Alarm event display

### CARACTÉRISTIQUES TECHNIQUES

- Durée de vie du capteur de CO<sub>2</sub>: 10 ans max
- Ecran OLED
- Affichage couleur à LED de la qualité actuelle de l'air
- Alimentation électrique : Adaptateur AC, entrée : AC 100~240 V, sortie : DC 5 V/1 A (Micro USB)
- Batterie de secours (Li-Ion 3,7 V)
- Affichage de la date et de l'heure
- Température de fonctionnement : -10 à 40°C
- Humidité de l'air : 0 % à 95 % (sans condensation)
- Plage de mesure : CO<sub>2</sub> : 0-5 000 ppm
- Affichage des événements d'alarme

### CARACTERÍSTICAS TÉCNICAS

- Vida útil del sensor de CO<sub>2</sub>: máx. 10 años
- Pantalla OLED
- Pantalla LED en color con la calidad del aire actual
- Alimentación de tensión: adaptador de CA, entrada: CA 100~240 V, salida: CC 5 V/1 A (micro USB)
- Batería de reserva (Li-Ion 3,7 V)
- Temperatura de funcionamiento: de -10° a 40°C
- Humedad del aire: del 0 % al 95 % (sin condensación)
- Rango de medición: CO<sub>2</sub>: 0-5000 ppm
- Indicación de eventos de alarma

Ref. No. Référence Referencia	EAN 4003318	Variants Exécutions Variantes	Battery Pile Pila	Finish Coloris Color	Box Quantity Unité d'emballage Cantidad de cajas
CO2WM110 AirSecure™ CO <sub>2</sub> detector	67964 3	Displays CO <sub>2</sub> , temperature, humidity, date and time	AC adapter   Input: AC 100~240V   Output: DC 5V/1A (Micro USB) Backup battery (Li-Ion 3.7V)		1

# COWM510

## CARBON MONOXIDE DETECTOR



### TECHNOLOGY AND FEATURES

- 10 year sensor lifespan (electrochemical)
- Display to indicate the CO concentration
- Incl. self-test function and voltage monitoring
- Audio and visual alarm
- A loud 85 dB alarm
- Detection Range: up to 60 m<sup>2</sup>
- 2x1.5V Alkaline AA batteries
- Displays when battery is low (displays "low-batt")
- Verified and certified in accordance with EN50291-1:2010+A1:2012
- Operating Temperature -20°C - +50°C

### CARACTÉRISTIQUES TECHNIQUES

- Durée de vie du capteur de 10 ans (électrochimique)
- Écran avec affichage de la concentration en CO
- Avec fonction d'auto-test et contrôle de la tension
- Signalisation d'alarme acoustique et optique
- Alarme sonore de 85 dB
- Zone de détection jusqu'à 60 m<sup>2</sup>
- 2 piles alcalines AA 1,5 V
- Indique lorsque la capacité des piles baisse (signalisation « low-batt »)
- Vérifié et certifié selon EN50291-1:2018
- Température de fonctionnement -20 °C à +50 °C

### CARACTERÍSTICAS TÉCNICAS

- Sensor con 10 años de vida útil (electroquímico)
- pantalla con indicación de la concentración de CO
- Incluye función de autocomprobación y monitorización de tensión
- Aviso de alarma acústico y visual
- Alarma potente de 85 dB
- Área de detección: hasta 60 m<sup>2</sup>
- 2 pilas alcalinas AAA de 1,5 V
- Indica el descenso de la carga de las pilas (señalización „low-batt“)
- Probado y homologado según EN50291-1:2018
- Temperatura de funcionamiento -20° - +50°

Ref. No. Référence Referencia	EAN 4003318	Variants Exécutions Variantes	Battery Pile Pila	Finish Coloris Color	Box Quantity Unité d'emballage Cantidad de cajas
COWM510	89164 9	CO detector	2x1.5V Alkline AA batteries	white	1

# HSZU10001

## MAGNET MOUNTING SET



### TECHNOLOGY AND FEATURES

- Quick and clean assembly without drilling
- Simple attachment and removal of the smoke alarm device through magnetic connection

### CARACTÉRISTIQUES TECHNIQUES

- Montage rapide et propre sans perçage
- Fixation et retrait simples du détecteur de fumée grâce à une connexion magnétique

### CARACTERÍSTICAS TÉCNICAS

- Montaje rápido y limpio sin perforar
- Montaje y desmontaje sencillo del dispositivo detector de humo mediante conexión magnética

Ref. No. Référence Referencia	EAN 4003318	Variants Exécutions Variantes	Battery Pile Pila	Finish Coloris Color	Box Quantity Unité d'emballage Cantidad de cajas
HSZU10001	68997 0	Magnet Mounting Set		silver	1

# LD1118

## FIRE BLANKET



### TECHNOLOGY AND FEATURES

- Tested and certified as per DIN EN 1869:2019 by MPA Dresden
- Easy to use –fire blanket unfolds automatically when removed by pulling the straps.
- Material: coated fibreglass fabric
- Dimensions: 1 m x 1 m
- Weight: approx. 950 g gross
- Includes robust pouch with eyelet for wall mounting

### CARACTÉRISTIQUES TECHNIQUES

- Contrôlée et certifiée selon DIN EN 1869:2019 par le MPA (Dresde)
- Facile d'utilisation : la couverture anti-feu se déplie automatiquement en tirant sur les rubans.
- Matériau : tissu en fibres de verre enduites
- Dimensions : 1 m x 1 m
- Poids : env. 950 g brut
- Sac robuste avec œillet pour fixation murale inclus

### CARACTERÍSTICAS TÉCNICAS

- Probada y certificada según DIN EN 1869:2019 a través de MPA Dresden
- Fácil de usar: la manta ignífuga se despliega automáticamente al extraerla mediante las correas tensoras.
- Material: tela de fibra de vidrio recubierta
- Medidas: 1 m x 1 m
- Peso: aprox. 950 g brutos
- Incluye una bolsa resistente con argolla para el montaje en la pared

Ref. No. Référence Referencia	EAN 4003318	Variants Exécutions Variantes	Battery Pile Pila	Finish Coloris Color	Box Quantity Unité d'emballage Cantidad de cajas
LD1118 Fire Blanket	86672 2				1

# AFS625 FIRESTOP

## FIRE EXTINGUISHING SPRAY



### TECHNOLOGY AND FEATURES

- 625 ml highly effective foam extinguishing agent
- Easy to use – just like a conventional spray can
- Spraying range (max. distance between source of fire and user) up to 4 m
- Spray time approx. 25 seconds
- Weight: approx. 900 g gross

### CARACTÉRISTIQUES TECHNIQUES

- 625 ml d'agent d'extinction moussant ultra efficace
- Utilisation facile - fonctionnement similaire à celui d'une bombe aérosol classique
- Distance de pulvérisation (distance max. entre foyer d'incendie et utilisateur) jusqu'à 4 m
- Durée de pulvérisation env. 25 secondes
- Poids : env. 900 g brut

### CARACTERÍSTICAS TÉCNICAS

- 625 ml de espuma extintora de alta eficacia
- Manejo sencillo como el de un bote de spray convencional
- Alcance de pulverización (distancia máx. entre el foco del incendio y el usuario) de hasta 4 m
- Tiempo de pulverización de aprox. 25 segundos
- Peso: aprox. 900 g brutos

Ref. No. Référence Referencia	EAN 4003318	Variants Exécutions Variantes	Battery Pile Pila	Finish Coloris Color	Box Quantity Unité d'emballage Cantidad de cajas
AFS625 Fire Stop	85727 0	Fire Stop Spray			6



# HSWM10000

## FLOOD DETECTOR



### TECHNOLOGY AND FEATURES

- 2 contact points directly on the detector – contact points can also be detached and fitted (cable length approx. 150 cm)
- Immediate audible reaction on contact with water
- A loud alarm of 85 dBA

### CARACTÉRISTIQUES TECHNIQUES

- Possibilité de monter 2 points de contact directement au niveau du détecteur ou à distance (longueur du câble env. 150 cm)
- Réaction acoustique immédiate en cas de contact avec de l'eau
- Alarme sonore de 85 dB

### CARACTERÍSTICAS TÉCNICAS

- 2 puntos de contacto directamente en el detector; también es posible desplazarlos (cable de aprox. 150 cm de longitud)
- Reacción acústica inmediata si se produce contacto con agua
- Alarma potente de 85 dBA

Ref. No. Référence Referencia	EAN 4003318	Variants Exécutions Variantes	Battery Pile Pila	Finish Coloris Color	Box Quantity Unité d'emballage Cantidad de cajas
HSWM10000	55082 9		9 V Block Alkaline	white	1

# TEST-SPRAY RM

## FOR SMOKE DETECTORS



### TECHNOLOGY AND FEATURES

- In case of no alert please repeat test
- Change detector if no alert is given after 5 seconds of testing
- Free of chlorine, fluorine, CHC/CFC, PCB, lead or other noxious substances

### CARACTÉRISTIQUES TECHNIQUES

- Si aucune alerte n'est activée, veuillez recommencer le test
- Changement du détecteur à faire si une alerte n'est pas donnée après 5 seconde de test
- Sans chlore, fluor, CHC/CFC et PCB, ne contient aucune autres substances nocives pour l'organisme

### CARACTERÍSTICAS TÉCNICAS

- Si el detector de humo con alarma no emite ninguna alarma, repetir la prueba
- Si no se produce ningún aviso de alarma tras una pulverización de aprox. 5 segundos, sustituir el detector de humo
- Libre de cloro, flúor (CFC/HCFE), PCB, plomo y otras sustancia nocivas

Ref. No. Référence Referencia	EAN 4003318	Variants Exécutions Variantes	Battery Pile Pila	Finish Coloris Color	Box Quantity Unité d'emballage Cantidad de cajas
Test-Spray RM 1 25 ml SB	43868 4	RM 125ml			6



# ABUS SHOP IN SHOP



Set your business apart from the crowd and benefit from individual sales concepts. Make your customers feel comfortable in your store and create experiences that go beyond the mere provision and sale of goods.

- Homely atmosphere with applied products
- Light elements for counters and shop elements

From a sales psychological point of view, how you design your shop is crucial for your economic success. We help you to make your sales area customer-friendly.

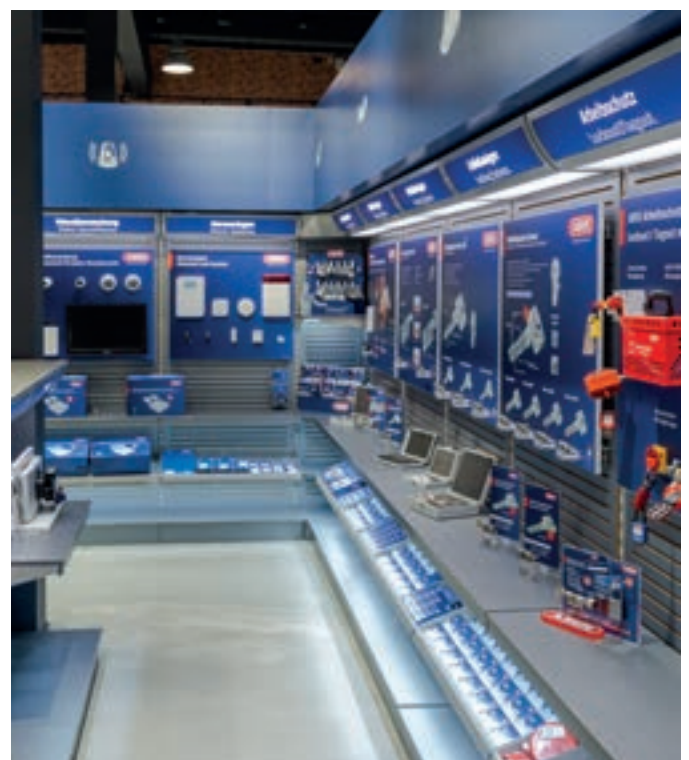



#### SHOP ELEMENTS

The modular presentation and sales system for your shop.

- Topic-oriented overview
- Uniform and modern design



#### COUNTERS

Make the counter to the focal point of your sales area.

- Individually tailored to your business
- Can be used as a coffee bar or for cutting keys and much more



#### CUBE

Present products realistically and compactly. Ideal for small spaces.

- A real eye catcher
- Assembled real products in a professional way



#### SECURITY HOUSE

Bring the "home security" experience closer to your customers. Realistic and simple.

- Walk-in exhibition
- Advice in a private and homely atmosphere



# ABUS TEGO SYSTEM

ABUS is synonymous with security. Our TEGO system brings the world of security technology to life with a uniform presentation of goods and well-thought-out customer guidance.



## Padlocks

### LONG-DISTANCE EFFECT

The head panels categorize the product range areas. In this way, the customer immediately knows which area he is currently in.



### OVERVIEW

The lateral segmentations create clear demarcations from the next product range. The easy-to-understand symbols make it possible to see all other product fields at a glance. This ensures more clarity and better orientation.



### STEP BY STEP INSTRUCTIONS

The information board helps to find the right safety product for the respective purpose. Statistics, comparison tables and information on assembly or application enable the customer to select the right product.



### TOUCH AND EXPERIENCE

Different demo models show various securing options and at the same time how these are correctly attached. This illustrates the value and handling of the various backups.

# MODULAR DISPLAY SYSTEM

Whether made of cardboard or metal: With the modular display systems from ABUS you will always get a suitable solution. Thanks to interchangeable components, the display can be quickly adapted to the new goods and campaigns.

We can manufacture individualized parts for you, even for small runs. Regardless of whether the goods are to be presented large in the store or small on the counter. With our range you can find the right display for every need. **Just talk to us. We would be happy to advise you.**



COUNTER DISPLAY (INCL. 6 HOOKS)  
300 X 450 MM



3-LEVEL-DISPLAY  
600 X 1500 X 400 MM



BLISTERHOOK DISPLAY  
600 X 1600 X 400 MM



1/4-RANGE DISPLAY  
600 X 800 X 400 MM



T-STAND DISPLAY  
600 X 1800 X 400



**MORE DISPLAYS ON REQUEST!**

# EXAMPLES OF SAMPLE CASES

---

We offer many different sample cases to help you test and use our products.

In addition to the examples below, there are other ways to provide you with the right sample case. **Feel free to contact us.**



72793 TITANIUM 96/98TI



12325 93RK



54932 83-SERIES



07263 LOCKOUT/TAGOUT BIG



70688 LOCKOUT/TAGOUT SMALL





## ABUS ENGRAVING SERVICE

Personalizing of brass steel and aluminium padlocks

## SERVICE GRAVAGE ABUS

Personnalisation des cadenas en laiton ou en aluminium

## SERVICIO DE GRABADO PARA CANDADOS ABUS:

Para personalizar candados de latón y aluminio



## CHAIN ATTACHMENT SET

- For 40 to 60 mm padlocks
- Fixes padlocks to location, prevents loss and contamination of padlock
- Easy to fit: Rivet to shackle and screw to location
- Supplied with 3 shackle clamps: For 6 to 10 mm shackles

## CHAÎNETTE POUR CADENAS

- Pour cadenas de taille de 40 à 60 mm
- Permet d'attacher le cadenas à un endroit précis. Evite la perte et la détérioration de cadenas
- Fixation facile sur l'anse à l'aide d'un cerclage et de l'équerre par 2 vis
- Livrée avec 3 cerclages pour anses de diamètre de 6 à 10 mm

## JUEGO DE FIJACIÓN PARA CADENAS

- Para candados de 40 a 60 mm
- Sistema de sujeción que fija y asegura un candado a una cadena, para evitar su pérdida o deterioro
- Fácil de montar: se remacha el arco y se fija a un punto atornillando
- Suministrado con 3 sujeciones diferentes de arco: Para arcos de 6 a 10 mm

**CUSTOM KEYS SYSTEMS & KEY CHARTING SERVICE AVAILABLE**



Keyed Different (KD)



Keyed Alike (KA)



Master Keyed (MK)

**ABUS PINNING KIT FOR SELF-ASSEMBLY OF CYLINDERS  
 ABUS VALISES DE MONTAGE: POUR UN MONTAGE SOI-MÊME EN ATELIER  
 ABUS KIT QUE PERMITE AL USUARIO MONTAR SUS PROPIOS CILINDROS**



**PLUS CYLINDER REKEYING KIT**



**SERVICE KIT FOR 24RK & 34 & 72**



**85 PINNING KIT**



**83 SERVICE KIT**

# KEY BLANKS

---



# KEY BLANKS

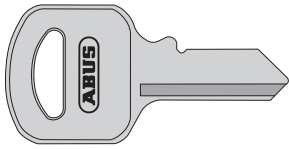

55/30, 54TI/30



64TI/20

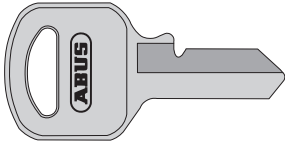

55/35, 54TI/35

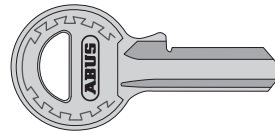

64TI/25

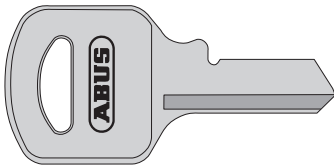

55/40, 54TI/40



65/15 R

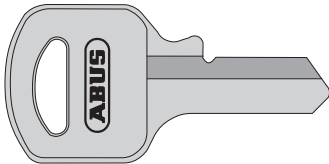

55/45, 54TI/45



65/15 L

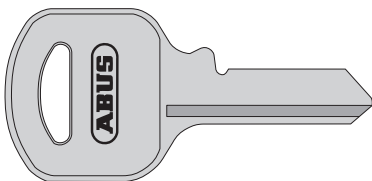

55/50, 54TI/50, 54TI/60

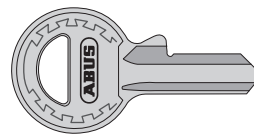

65/20

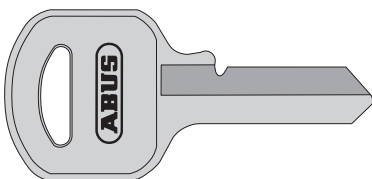

55/60

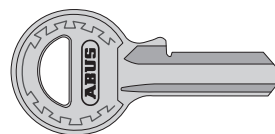

65/25



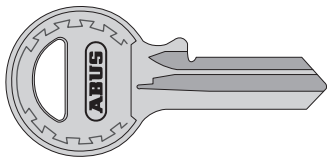

65/30 + 35\*

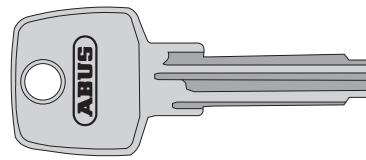

75/30 + 40, 25/70



65/30 + 35, 64TI/30 + 35

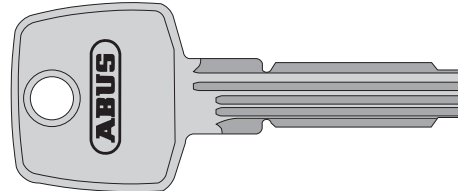

75/50 + 60, 66TI, 96TI, 98TI

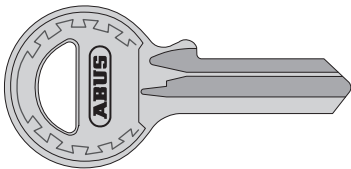

65/40 + 45\*

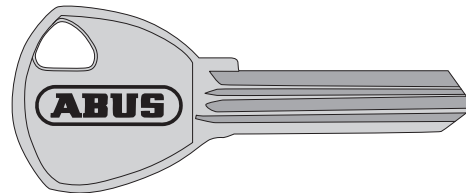

80TI

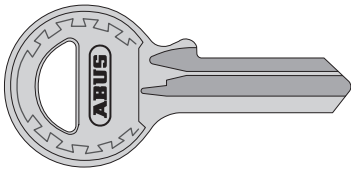

65/40 + 45, 64TI/40 + 45, T65, 70, 70AL, 5/40

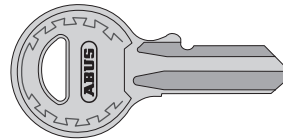

T84MB/30 R

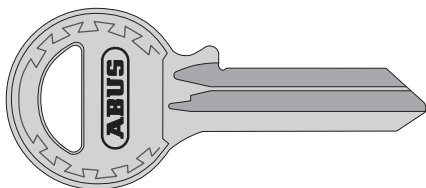

65/50 + 60\*

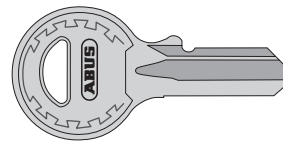

T84MB/30 L

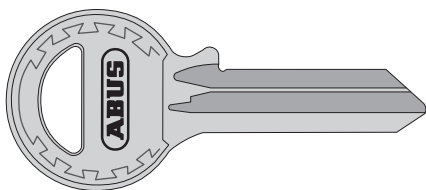

65/50 + 60, 64TI/50 + 60, 5/45, 5/50, 5/55

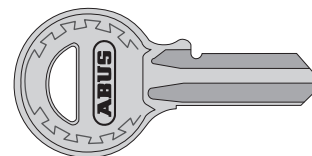

T84MB/40 R



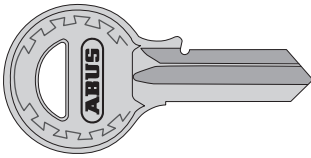

T84MB/40 L

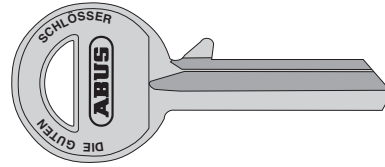

85/40 L

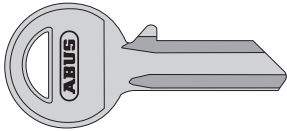

85/20 + 25 R

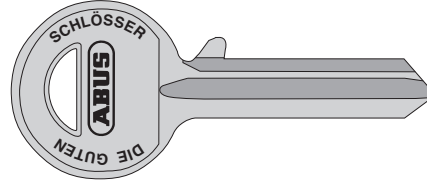

85/50 + 60 L

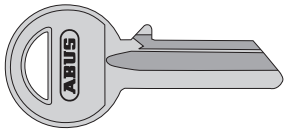

85/20 + 25 L

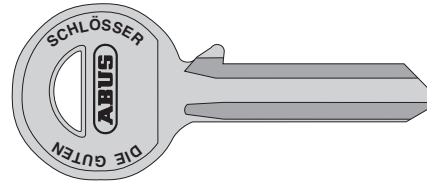

85/50 + 60 R, 82/90, 90/50, 92/80

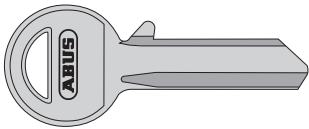

85/30 R

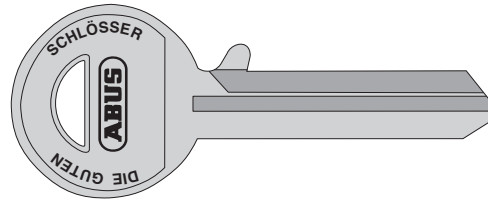

85/70 L

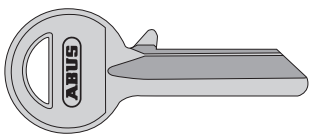

85/30 L

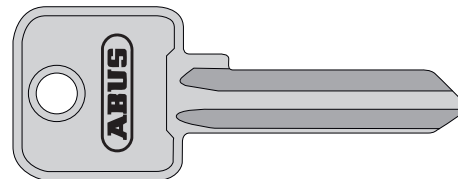

90RK/50

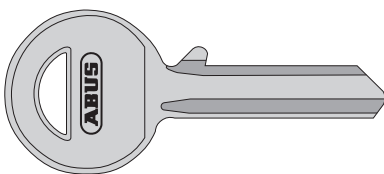

85/40 R

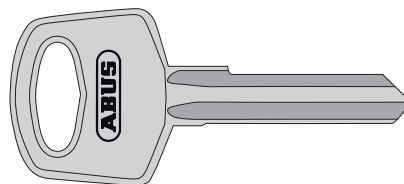

72 series - RH6



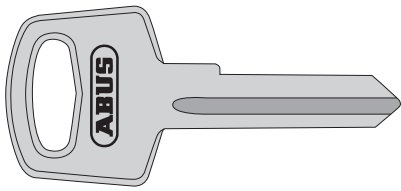

72 series - American Lock

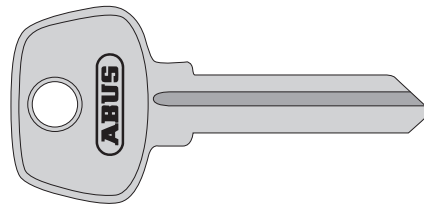

83 series - #700 Sargent

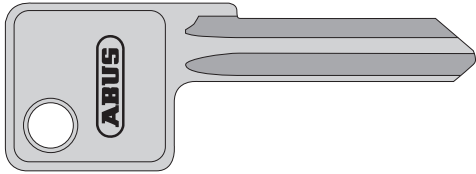

83 series - #100 Yale No. 8

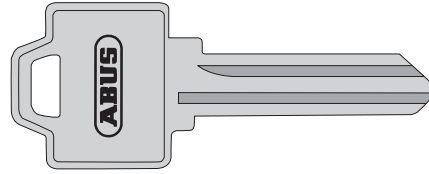

83 series - #800 Weiser/Falcon

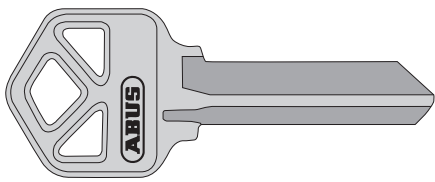

83 series - #200 Kwikset

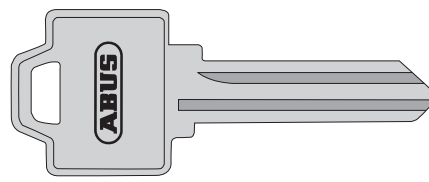

83 series - #900 Arrow

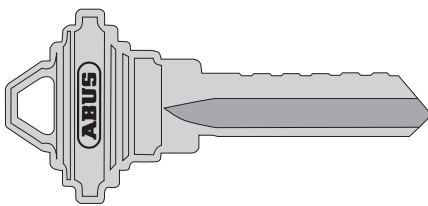

83 series - #300 Schlage

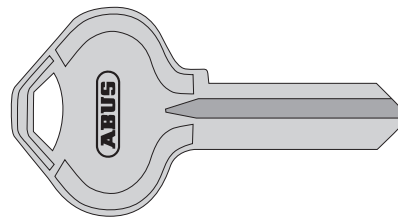

83 series - #1000 Ruswin D1-54

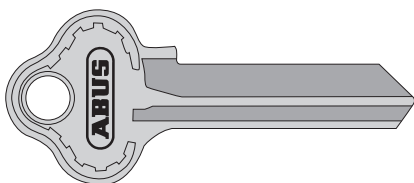

83 series - #340 Lockwood

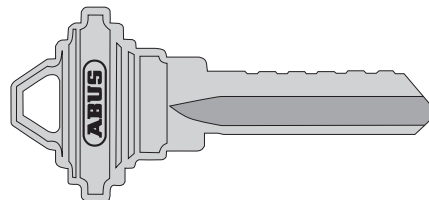

83 series - #3000 Schlage CL

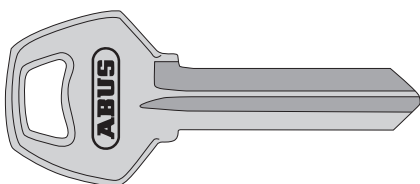

83 series - #400 Corbin 60

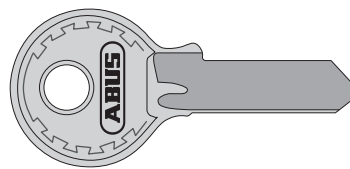

83 series - #6000 Master W6000

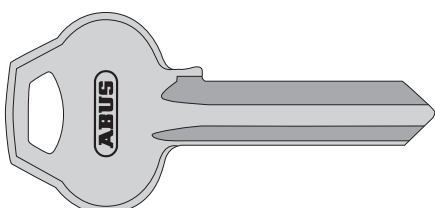

83 series - #400 Corbin 60

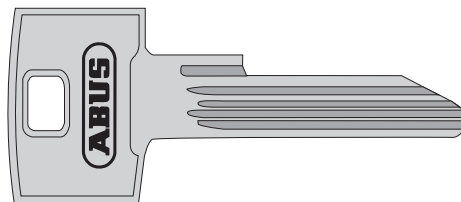

83 series - #888 ABUS



# INDEX

	Page
5	57
6KS	126
8KS	126
9KS Loop	127
10KS	127
12KS Loop	128
20	39
24	42
24IB	43
24IBWY	43
24RK	42
25	41
26	40
26WY	40
28	44
34CS	24
35/55	20
37/55	18
37/60	17
37RK/55	18
37RK/70	16
37RK/80	15
37ST	19
41	46
54TI	55
55	68
<b>645TI</b>	79
64TI	52 - 53
64TI/50HB60-150	54
65	66 - 67
65CS	66 - 67
70	70 - 71
70AL	72
70IB	70 - 71
72	73 - 74
72/30	136 - 137
72/30CAB	136 - 137
72/40 Love Lock	76
72IB	73 - 74
72LL/40 Love Lock	77
74	134 - 135
75	64
75IB	65
76	131 - 133
78	85
78KC	85
80TI	51
82	61
82TI	49
83/40	30
83/45	30
83/50	29
83/55	26
<b>83/60</b>	25
83/80	25
83AL	32
83CS/50	29
83CS/55	26
83S/45LFIC	31
83WP	27
83WPCS	27

	Page
83WPIB	28
84IB	69
85	62 - 63
85WY	62 - 63
88	59
90RK/50	35
92	58
93RK	33
96TI	50
98TI	48
100	115
110	114
115	117
125	112
130	112
131	118
138	118
140	113
144	91 - 92
145	89 - 90
146TSA	95
147TSA	94
148TSA	93
155 Black & White	86
155	86
158	82
158KC	83
160	84
165	87
165IB	88
180IB	81
183AL/45	34
190CS/60	80
200	116
220	45
289	60
300	117
466BM	96
620TSA	236
727	108
737	108
767	106
777	107
787	103
787 Big LED	100
787 Big	101
787 LED	102
787 Smart	98
797	105
797 LED	104
797 Smart	99
1200	196
1200   2200   2300	196
1850	125
2110	187
2130	188
2203	195
3630	192
7010	189
7030	190
7035	191



	Page
<b>A</b>	
A93	173 - 174
ABUS Emma	166
ABUS Supportbox	164
AC4100	201
AC4223	201
AC7023	199
AC7124	200
AC7303	200
AC7436	199
AF5625 FireStop	288
Automotive Security Bundle	240
<b>B</b>	
B5LT	169
<b>C</b>	
C503-526	152
C553-C565	153
CFA3100	220
CF3100	221
CF53100	222
CFT3100	221
CFW3100	222
CO2WM110 AirSecure™	284
Cobra	125
Combiflex™	124
Combiloop 205	124
ConHasp 230	242
ConHasp Granit 215/100	241
COWM510	285
<b>D</b>	
D10PS	177 - 178
D6 Basic	175 - 176
DI141	110
DI142	111
<b>E</b>	
E201	138
E203	139
E211	138
E212	138
E218-233	140
E245	141
EFS65	205
ES PZ2 ROUND FOREND	204
ES PZ3	205
ES SI	207
ES WC ROUND FOREND	205
ESK PZ2 Universal	206
ESR PZ	207
<b>F</b>	
FAS97	214
FCA3000	223
FG110	218
FG300	217
FG300A	216
FSB 250 EÖ	209
FTR38 / PB38	213
FTR42 / PB42	213
FTR70	212
FTR90 / PB92	212
FTS88	214
<b>G</b>	
GWM100ME	283

	Page
<b>H</b>	
H701-H712	154
H751-H752	155
H770	156
HSWM10000	289
HSZU10001	286
<b>J</b>	
JC1100A DANNI	246
JC1200A JONAS	251
JC1300 JANITA	262
JC1430 NOAH	246
JC2100A GRETA	244
JC2208 EMMA	244
JC3100A DENNY	272
JC3400A TOBI	273
JC3500 JANNIC	273
JC3624 PETER	274
JC3700 ROBIN	274
JC4100A SINA	249
JC4200A LIA	248
JC4300A MARA	247
JC4400 LENNY	249
JC4500 MARC	250
JC4600 NINA	245
JC4700 KAY	245
JC4800 ISA	247
JC4900 JULIAN	248
JC5100A NESSA	256
JC5200A MILLIE	257
JC5401 MINA	258
JC6100A LEIF	256
JC6200 LUCA	257
JC6324 ZOE	268
JC6408 HANNA	266
JC6412 MIKE	266
JC6416 LARA	265
JC6420 TESSA	267
JC6440 LINDA	267
JC6460 MAYA	268
JC6520 NILS	252
JC6540 LINUS	252
JC6560 TILL	253
JC6602 MIMI	250
JC6715 THEO	253
JC6800 LEON	254
JC6900 MAX	254
JC7100 NINO	258
JC8320 JAN	251
JC8630 LORI	261
JC8650 LILY	260
JC8660 JULIE	261
JC8670 LUCY	259
JC8680 DANA	260
JC8690 MILA	259
JC8700 MALTE	265
JC8710 KIM	264
JC8720 ROBBI	263
JC8730 EMIL	264
JC8740 PIA	263
JC9100 ERIC	262
JC9203 HENRY	270
JC9210 TIM	271

# INDEX

	Page
JC9220 NIC	269
JC9308 LOU	270
JC9330 FINN	271
JC9500 FELIX	272
JC9514 BEN	269
<b>K</b>	
KLS114	197
KLZS714	198
<b>L</b>	
LD1118	287
Lockout / Tagout Sets	163
LockPoint	160
LockPoint Singlewall	161
<b>P</b>	
P110-550	146
P600	147
P604	149
P606	148
P616	150
P625	150
Permit Redbox™	158
PPDF14520	231
PPDF16000	232
PPDF18000	233
PPIC NEXT GEN	226
PPIC32020	228
PPIC34520	229
PPIC36520	230
PPIC90520	227
PR1500	186
PR2600	185
PR2800	184
<b>R</b>	
RS87	215
RS97	215
RWM150	280
RWM160	281
RWM165	282
RWM250	278
RWM450 Funk	279
RWM90	277
<b>S</b>	
Safety Redbox™	157
SB15	240
SK69	193
SK78	192
SL Bags	162
SSB400	210
<b>T</b>	
T1 00/T1 50	159
T65AL myLock	75
T65AL myLove	78
TAS102	194
TAS82	194
Test-Spray RM	290
TI12/TI14	170 - 171
Titalium Color Line	172
TKZ40	204
TL-515	237
TL-517	237
TL-525	238
TL-530	238

	Page
Trainingstower LoTo	165
TVAC1 7520	234
TVAC4-7030	234
<b>U</b>	
ULC100	151
<b>V</b>	
V303-313	142
V423-426	143
V442-448	144
V500	145
<b>W</b>	
WA50	121
WBA100	120
WBA60	121
WBA75	120
WCH	122
WSB 170	208
WSB 170 KU	209
WSBHT 190	208

# TERMS AND CONDITIONS

---

## General

1. Quotations, tenders or orders with no stipulated acceptance period shall not be binding.
2. The present Terms and Conditions shall be binding if they have been declared applicable either in our tender, product/price list, or in our confirmation of the order. Terms and conditions of the Buyer that diverge from the present General Terms and Conditions shall not be binding unless and only to the extent they have been expressly accepted by us in writing.
3. Save as provided otherwise, advertising literature and catalogues shall not be binding. Data contained in technical documents shall be binding only if expressly guaranteed.

## Prices

1. Save as provided otherwise, our prices are deemed to be in Euro.
2. If the conditions on which the formation of our prices was based on, in particular currency changes or governmental taxes, charges, fees, customs duties, etc., were to vary between the submission of the tender and the contractually agreed delivery date, we shall be entitled to adapt our prices and other terms of supply to prevailing circumstances.

## Terms of Payment

1. Unless stated otherwise, our invoices shall be due for payment immediately and shall be settled immediately, without any cash discount or other deduction allowed. Payments shall be made into one of our bank accounts as printed on our invoices. Payment shall be deemed to have been made when the amount due has been credited to any one of these accounts in Euros and is at our free disposal. Payment of our invoices must be made in full and reducing payment due against counter-claims raised by the Buyer is not admissible.
2. If the Buyer is late with respect to the agreed terms of payment, he shall be in default without reminder and shall be liable to pay default interest, from the 31st day counting from the date of the invoice, at a rate of 8% p.a.

## Reservation of Title

1. We shall remain the owner of all supplied products until we have received payment in full of the agreed amount. On conclusion of the Contract, the Buyer authorizes us to have said reservation of title entered pursuant to the laws of the countries concerned, in the public registers kept for this purpose by the competent authorities of the respective countries, and to complete all relating formalities. During the whole period of the reservation of title, the Buyer shall, at his expense, maintain the supplies, take out all necessary insurance with a view to protecting them, for our benefit, against theft, total loss, fire, water and other risks, and take all further measures in order to ensure that our title is not prejudiced in any way whatsoever.
2. If the supplied products were delivered prior to payment of all amounts owed by the Buyer under the Contract, we shall retain title to the product until payment in full insofar as this is admissible under the law in the area of application of which the supplied product is located. If this law does not permit the reservation of title but allows us to reserve other security interests in the supplied product equalling the German retention of title, we may exercise all rights of this kind. The Buyer is obliged to assist us in any action taken to protect our title or the right to the product which replaces such title.

## Liability

Save as provided otherwise, the Buyer shall have no claims other than those expressly stated in the present General Terms and Conditions, irrespective of the grounds they may be based on. Thus, the Buyer shall raise no claim for damages or a reduction in price, and he shall have no right to withdraw from or terminate the Contract, unless such claim or right is expressly provided for under the General Terms and Conditions. The Buyer shall on no account have a claim for compensation of damage that does not affect the products as such, as for instance loss of production, loss of use, lost orders, profit loss or any other direct or consequential damage. This exclusion of liability shall not apply in the event of gross negligence, unlawful intent or insofar as mandatory law provides otherwise.

## Compliance with Export Control Regulations

1. Our obligation to fulfill this agreement is subject to the proviso that the fulfillment is not prevented by any impediments arising out of national and international foreign trade and customs requirements or any embargos or other sanctions, in particular export control provisions.
2. If the Buyer transfers goods delivered by us to a third party worldwide, the Buyer shall comply with all applicable national and international (re-) export control regulations. In any event the Buyer shall comply with the (re-) export control regulations of Switzerland, the Federal Republic of Germany, of the European Union and of the United States of America.
3. If required to conduct export control checks, the Buyer, upon our request, shall promptly provide us with all information pertaining to particular end customer, destination and intended use of goods provided by us, as well as any export control restrictions existing.
4. The Buyer shall indemnify us and hold us harmless from and against any claim, proceeding, action, fine, loss, cost and damages arising out of or relating to any non-compliance with export control regulations by the Buyer, and the Buyer shall compensate us for all losses and expenses resulting thereof, unless such noncompliance was not caused by fault of the Buyer. This provision does not imply a change in burden of proof.

## Applicable Law

The present contractual relationship is governed by German substantive law. The application of the United Nations Convention on Contracts for the International Sale of Goods (the Vienna Law on the International Sale of Goods) of April 11, 1980, shall be excluded.

## Jurisdiction

The place of jurisdiction for the Customer and for us shall be Wetter (Ruhr), Germany.



Security Tech Germany

© **ABUS** | August Bremicker Söhne KG  
**abus.com**

---

Altenhofer Weg 25  
58300 Wetter  
Germany  
info@abus.de  
+49 23 35 - 634 0

© **ABUS** | Africa, Middle East & Asia  
**abus.com**

---

© **ABUS** | North & South America  
**abus.com**

---

